

# SONIFEX

Manufacturers of Audio Products for AV,  
Installed Sound, Broadcast Radio & Broadcast TV



## Dante® & AES67 AoIP Products

Dante®  
Commentator Units

Dante® Audiophile  
Interfaces

Dante® Multi-Channel  
Audio Interfaces

PTP Grandmaster  
Clock

AES67 Multi-Channel  
Audio Interfaces

Headphone  
Distribution System

AES67 Stream  
Mix Monitor

AES67 Talkback  
Intercoms

Presenter In-Ear  
Monitoring System



AES67 *now!*



RAVENNA



## **Dante® Products**

<b>Dante® Commentator Units</b>	<b>3-7</b>
AVN-CU2-DANTE Configurable Dante Commentary Unit for 2 Commentators	3
AVN-CU4-DANTE Configurable Dante Commentary Unit for 4 Commentators	6
<b>Dante® DIO Audiophile Interfaces</b>	<b>8-11</b>
DIO01 Dante to Analogue XLR Stereo Output	8
DIO02 Analogue XLR Stereo Input to Dante	9
DIO03 Dante to Headphone Output (1/4" & 3.5mm Jacks) With Volume Control & Limiter	9
DIO04 Dante to Analogue Phono Stereo Input & Output	9
DIO05 Dante to Analogue Terminal Block Stereo Input & Output	10
DIO06 Dante to AES3 XLR Stereo Input & Output	10
DIO07 Dante to AES3-id BNC Stereo Input & Output	10
DIO08 Dante to AES3 Terminal Block Stereo Input & Output	11
DIO09 Microphone Input to Dante	11
DIORK 19" AVN-DIO Mounting Rack	11
<b>AVN-DIO10 Dante® to 3G/HD/SD-SDI Embedder/De-Embedder</b>	<b>12-15</b>
<b>Dante® Multi-Channel Audio Interfaces</b>	<b>16</b>
AVN-AIO4 4 Input, 4 Output Dante Interface, PoE	16
AVN-AIO8 8 Input, 8 Output Dante Interface, PoE	16
AVN-AO16 16 Output Dante® Interface, PoE	16
 <b>AES67 RAVENNA Products</b>	
<b>AVN-GMCS PTPv2 Grandmaster Clock &amp; GPS Receiver</b>	<b>17</b>
<b>AVN-PXH12 12 x 2 Channel AES67 Stream Mix Monitor</b>	<b>18</b>
<b>AVN Portals Multi-Channel Audio Mix Engine Interfaces Using AES67 AoIP</b>	<b>19-22</b>
AVN-PA8 8 x Stereo Analogue Line Inputs & Outputs, AES67 Portal	20
AVN-PD8 8 x Stereo AES3 Digital Inputs & Outputs, AES67 Portal	21
AVN-PM8 8 x Mic/Line Inputs & 8 x Line Outputs, AES67 Portal	22
<b>Headphone Distribution System</b>	<b>23</b>
AVN-HA1 Analogue Headphone Amplifier for AVN-PA8/D & AVN-PM8/D Portals	23
AVN-HD1 Digital Headphone Amplifier for AVN-PD8/D Portals	23
<b>Talkback Intercom System Using AES67 AoIP</b>	<b>24-26</b>
AVN-TB6 6 Button Talkback Intercom	24
AVN-TB6D 6 Button Desktop Talkback Intercom	25
AVN-TB20AR 20 Button Advanced Rackmount Talkback Intercom	25
AVN-TB20AD 20 Button Advanced Desktop Talkback Intercom	25
AVN-TB10AR 10 Button Advanced Rackmount Talkback Intercom	26
<b>Presenter In-Ear Monitoring System Using AES67 AoIP</b>	<b>27-28</b>
AVN-MPPR 4 Channel Presenter In-Ear Monitoring Remote Controller, AES67	27
AVN-MPTR Technician Remote Controller	28
AVN-PX8X4C 8 x 4 Channel Mix Engine, 24 Inputs, 16 Outputs, AES67	28



## Two New Dante® AoIP Commentator Units



### AVN-CU2-DANTE Configurable Dante Commentary Unit for 2 Commentators

The AVN-CU2-DANTE takes a new approach to provide a multi-purpose configurable tool for commentary teams. Its power lies in the impressive mix engine which overlays the usual Dante® Controller settings. Once Dante® flows have been made, inputs and outputs can be mixed freely to AoIP or physical inputs and outputs, controlled using the programmable buttons and rotary encoders, which control the gain and pan of inputs, outputs or cross-points, allowing total flexibility for different situations.

It can be used in any number of different commentary situations, controlled manually or remotely and controls can be 'locked down' so that they can't be tampered with or altered, to guarantee reliable operation. Housed in a rugged and intuitive, user-friendly package, it's a truly different way of looking at how commentary units should operate.

Traditional commentary units have fixed analogue and digital I/O and fixed controls in fixed positions on the unit. Their inputs and outputs are defined at hardware design and are thus limited by that initial design, including limited routing, mixing and DSP of the audio pathways.

We've taken a different approach with the AVN-CU2-DANTE. It was designed from the ground up to be totally flexible in operation and the use of Dante AoIP means that inputs and outputs can be added as required (up to a max of 16 per unit). Because any physical analogue or digital input can be mixed and routed with any Dante AoIP input to any physical output or Dante output, you can define your own audio pathways. Additionally you can choose which of those pathways need to be controlled (volume and pan) by the use of rotary encoders.

Using a built-in web GUI, up to 4 nameable pages of 6 rotary encoders (24 in total) can be placed on the mix matrix at inputs, outputs or cross-points. Each rotary encoder has a separate colour-coded meter section showing the channel name, detailed level metering and left/right panning on a bright daylight reading display. Colours can be programmed per encoder to quickly identify particular source groups, so headphone source selection becomes intuitive.

The AVN-CU2-DANTE provides two mic/line inputs with a wide, adjustable gain range and has two stereo headphone outputs with lockable jack sockets, suitable for operation by two commentators.

It's powered using Power over Ethernet (PoE), using Neutrik EtherCON connectors, with primary and secondary ports for power and data redundancy.

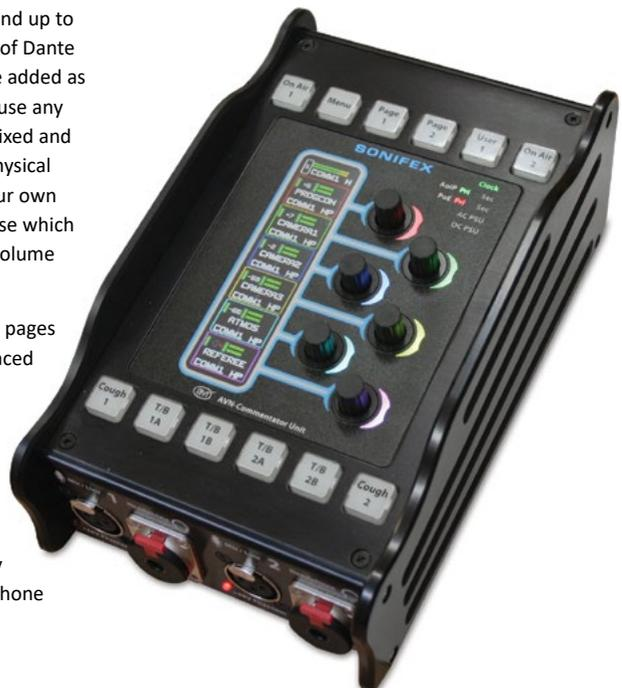

There's an additional 4 pin XLR 12V DC input. The unit supports up to 16 input and output AoIP channels and up to 16 simultaneous input and output AoIP streams.

The 6 push-button rotary encoders control input and output levels and panning. The 12 key-cap buttons are fully configurable for any button function.

Metering is available per input/output, with output metering configurable as pre or post level adjustment. The top of the display shows output metering, a limiter indication and the name of the output. An adjustable limiter is available on every output and is applied automatically to prevent signal clipping.

The unit has 2 x locking mic/line inputs with +48V phantom power indication and 2 x headphone outputs on locking 6.35mm jack sockets.

Four wire I/O on rear panel RJ45 connectors provide an AES3 or analogue input and output that can be assigned as mic outputs (line level), talkback outputs, programme inputs or talkback inputs as desired.

In addition, the AES/analogue connections can be used as an insert or exit point into/out from the AoIP network.

The unit has dual redundant network ports on both RJ45 (PoE using 2 x Neutrik EtherCON® connectors) and SFP cages for long fibre runs.

There are 10 x configurable GPIO on a 15 way D-type connector with 1 x switched changeover output.



All of the buttons have key-cap text and can be configured. There are some standard operations available:

- 2 x On-Air buttons can be used to connect mic audio to the main output, either over AoIP or via the AES digital audio connection. The On-Air buttons can be locked if required.
- A Menu button can be used to access limited setup options on the TFT display.
- 2 x Page buttons change the display and encoders to monitor an additional set of sources, mix points or outputs. Up to 4 pages can be pre-programmed, e.g. one for talkback inputs, one for outputs, one to monitor other sources.
- 2 x Cough buttons take the commentator off-air while pressed.
- A User button can be programmed to perform any function using the web server.
- 4 x T/B (talkback) buttons can be configured to initiate talkback over AoIP or AES digital audio

connection, using 4 x talkback busses. The talkback buttons operate with lazy talkback, taking the commentator off-air when invoked.

- 6 x rotary encoders.
- 4 x pages of 6 rotary encoder positions (24 in total).

The illuminated 'Sonifex' logo acts as a power indication and there are illuminated LEDs to indicate network clock status, AoIP Primary and AoIP Secondary link status, PoE Primary, PoE Secondary and DC power active.



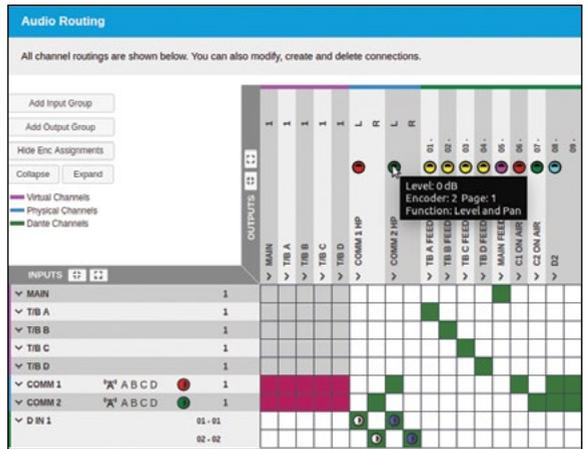

A visual mix-matrix makes setup simple and intuitive.

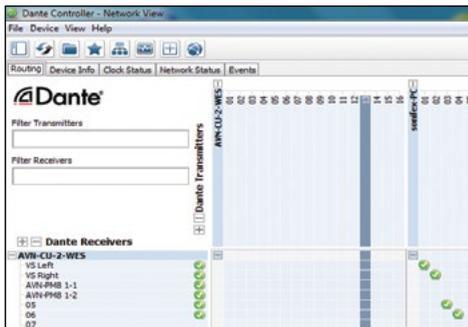

Stream setup to and from the unit is initially via Dante® Controller with more detailed configuration performed by using the built-in web GUI.



The unit can be fully remotely controlled from the web interface with front-panel lock-out options for every button and encoder.

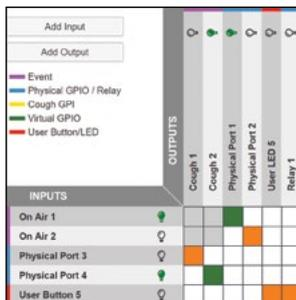

GPIO & VGPIO can be configured on a matrix to visually show actions, combined with button presses and input/output muting enabling some automation.

4 pages, each of 6 colour-coded rotary encoders, can be defined with encoders controlling volume and pan of inputs, outputs or cross-points.

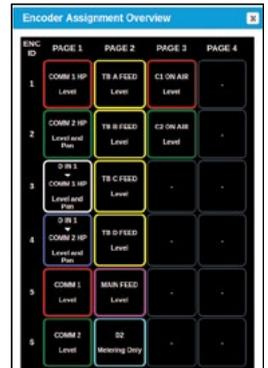



## AVN-CU4-DANTE Configurable Dante Commentary Unit for 4 Commentators

The AVN-CU4-DANTE is a portable commentator unit using Dante® AoIP. It is a dual version of the AVN-CU2-DANTE providing four mic/line inputs with a wide, adjustable gain range and four stereo headphone outputs with lockable jack sockets, suitable for operation by three or four commentators.



Fully featured, this unit allows you to handle virtually any commentary situation with both Dante AoIP and 4 wire connections, dual redundant Dante networking and multiple AC/DC/PoE+ power options. Up to 48 rotary encoders can be used on inputs, outputs or cross-points, allowing talkback feeds, commentary and audio mixing to be handled in one unit.

It has an abundance of 4 wire connections on the rear panel: 4 x analogue line inputs on XLR sockets with latching locks, 6 x analogue line outputs on XLR plugs and an RJ45 AES3 stereo input & output. These connections can act as a simultaneous analogue backup to the Dante AoIP connections.

The featureset is as per the AVN-CU2-DANTE, with the following differences. There are two displays with

a doubling of operational controls:

- 4 x On-air buttons.
- 4 x Page buttons, 2 for each half of the display.
- 4 x Cough buttons.
- 8 x Talkback buttons, up to 4 for each user and
- 3 x User buttons.
- 12 x rotary encoders.
- 8 x pages of 6 rotary encoder positions (48 in total).

Similar to the AVN-CU2-DANTE, the illuminated 'Sonifex' logo acts as a power indication and illuminated LEDs indicate network clock status, AoIP Primary and AoIP Secondary link status, PoE+ Primary, PoE+ Secondary and AC power active.



The front panel houses 4 x locking mic/line inputs with +48V phantom power indication and 4 x headphone outputs on locking 6.35mm jack sockets.

To power the unit, as well as the dual PoE+ ports and 12V 4 pin XLR DC input, there is an AC mains input on an IEC inlet, with a universal supply.

The unit has dual redundant network ports on both RJ45 (PoE+ using 2 x Neutrik EtherCON® connectors) and SFP cages.



The AVN-CU4-DANTE uses a web interface for remote control which emulates the physical front panel and displays the multiple encoder pages available.

Metering is displayed in real time, and all buttons and encoders can be locked-out from use individually and by button row and encoder page.



# Dante® Dante® DIO Audiophile Interfaces

If you're putting audio onto your Dante® network, make it the best audio quality that it can be. Introducing the new DIO audiophile Dante® interfaces

These simple plug and play audio interfaces provide a convenient and elegant method of connecting legacy analogue and digital audio equipment to the Dante AoIP audio network.

What's the difference between these units and others? The audio quality. We're using A/D and D/A circuitry that provides analogue performance that's 10 times better than similar competing products, offering >120dB of dynamic range.

If you're converting audio sources into AoIP, it makes sense to use the best converters that you can afford, to benefit the whole network. These cost effective products provide the answer.

Using Dante Controller for configuration and powered by PoE, these rugged aluminium boxes have side slots for screw mounting and contain superior

audio circuitry for optimal audio performance.

They use rugged Neutrik EtherCon® connectors and Neutrik lockable audio connectors for ultra-reliable connectivity.



## Superior Audio Performance

- >120dB dynamic range, sample rates supported up to 96kHz.
- 10 x better analogue audio performance than competing products.
- PoE powered with rugged Neutrik EtherCon® network connector.
- Neutrik locking XLRs, AES67 & Dante Domain Manager compliant.

### DIO01 Dante to Analogue XLR Stereo Output



The AVN-DIO01 is a Dante AoIP network to analogue XLR stereo output converter in the Sonifex DIO range of Dante input/output devices. It features two balanced analogue XLR outputs and one Neutrik EtherCon® connector for direct connection to a Dante AoIP network.

- 2 x balanced XLR analogue outputs.
- Neutrik EtherCon® Ethernet connection.

- Fully Dante compliant device.
- AES67 compatible.
- Dante Domain Manager compliant.
- Ultra-high quality, wide dynamic range D/A conversion, >120dB.
- Powered via PoE (Power over Ethernet).

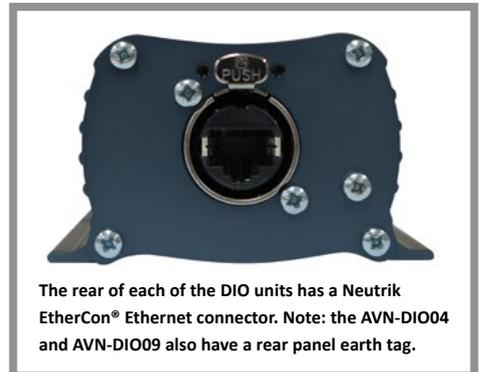

The rear of each of the DIO units has a Neutrik EtherCon® Ethernet connector. Note: the AVN-DIO04 and AVN-DIO09 also have a rear panel earth tag.

## DIO02 Analogue XLR Stereo Input to Dante



The AVN-DIO02 is an analogue XLR stereo input to Dante AoIP network converter in the Sonifex DIO range of Dante input/output devices. It features two balanced analogue XLR inputs and one Neutrik EtherCon® connector for direct connection to a Dante AoIP network.

- 2 x balanced XLR analogue inputs.
- Neutrik EtherCon® Ethernet connection.
- Fully Dante compliant device.
- AES67 compatible.
- Dante Domain Manager compliant.
- Ultra-high quality, wide dynamic range A/D conversion, >120dB.
- Powered via PoE (Power over Ethernet).

## DIO03 Dante to Headphone Output (1/4" & 3.5mm Jacks) With Volume Control & Limiter



The AVN-DIO03 is Dante AoIP network-to-headphones convertor in the Sonifex DIO range of Dante input/output devices. It features a single stereo headphone output available on two connections for 1/4" and 3.5mm jacks and a volume control for headphones level.

A simple headphone limiter can be switched in to prevent hearing damage by limiting the audio level sent to the headphones. The limiter has a threshold setting and a blue LED indication when active.

- 1/4-inch and 3.5mm jack analogue headphone outputs.
- Headphones volume control.
- Limiter on/off, threshold control and LED indicator.
- Neutrik EtherCon® Ethernet connection.
- Fully Dante compliant device.
- AES67 compatible.
- Ultra-high quality, wide dynamic range D/A conversion.
- Powered via PoE (Power over Ethernet).

## DIO04 Dante to Analogue Phono Stereo Input & Output



The AVN-DIO04 is a Dante to analogue phono stereo input & output convertor in the Sonifex DIO range of Dante input/output devices. It features stereo analogue input and output phono connections and one Neutrik EtherCon® connector for direct connection to a Dante AoIP network.

- 2 x analogue phono-type inputs.
- 2 x analogue phono-type outputs.
- Neutrik EtherCon® Ethernet connection.
- Fully Dante compliant device.
- AES67 compatible.
- Dante Domain Manager compliant.
- Ultra-high quality, wide dynamic range D/A and A/D conversion.
- Powered via PoE (Power over Ethernet).

## DIO05 Dante to Analogue Terminal Block Stereo Input & Output



The AVN-DIO05 is a Dante to analogue terminal block input and output converter in the Sonifex DIO range of Dante input/output devices. It features balanced stereo analogue inputs and outputs on a terminal block connector and one Neutrik EtherCon® connector for direct connection to a Dante AoIP network.

- 12 x terminal block connections (balanced stereo inputs and outputs).
- Neutrik EtherCon® Ethernet connection.
- Fully Dante compliant device.
- AES67 compatible.
- Dante Domain Manager compliant.
- Ultra-high quality, wide dynamic range D/A and A/D conversion, >120dB
- Powered via PoE (Power over Ethernet).

## DIO06 Dante to AES3 XLR Stereo Input & Output



The AVN-DIO06 is a Dante to AES3 digital input and output audio converter in the Sonifex DIO range of Dante input/output devices. It features stereo AES3 digital audio inputs and outputs on Neutrik XLR connectors, and one Neutrik EtherCon® connector for direct connection to a Dante AoIP network.

- 1 x stereo AES3 XLR input.
- 1 x stereo AES3 XLR output.
- Neutrik EtherCon® Ethernet connection.
- Fully Dante compliant device.
- AES67 compatible.
- Dante Domain Manager compliant.
- Powered via PoE (Power over Ethernet).

## DIO07 Dante to AES-3id BNC Stereo Input & Output



The AVN-DIO07 is a Dante to AES-3id digital input and output audio converter in the Sonifex DIO range of Dante input/output devices. It features stereo AES-3id digital audio inputs and outputs on BNC connectors, and one Neutrik EtherCon® connector for direct connection to a Dante AoIP network.

- 1 x stereo AES-3id BNC input.
- 1 x stereo AES-3id BNC output.
- Neutrik EtherCon® Ethernet connection.
- Fully Dante compliant device.
- AES67 compatible.
- Dante Domain Manager compliant.
- Powered via PoE (Power over Ethernet).

### Weights & Dimensions

#### Dimensions (Raw):

11.6cm maximum (W) x 7.3cm (D) x 4.3cm (H)  
4.6" (W) x 2.9" (D) x 1.7" (H)

#### Dimensions (Boxed):

17.4cm (W) x 9.5cm (D) x 5.6cm (H)  
6.9" (W) x 3.7" (D) x 2.2" (H)

#### Weight:

Nett: 0.2kg Gross: 0.3kg  
Nett: 0.44lbs Gross: 0.66lbs

## DIO08 Dante to AES3 Terminal Block Stereo Input & Output



The AVN-DIO08 is a Dante to AES3 digital input and output audio convertor in the Sonifex DIO range of Dante input/output devices. It features stereo AES3 digital audio inputs and outputs on terminal block connectors, and one Neutrik EtherCon® connector for direct connection to a Dante AoIP network.

- 6 x terminal block connections (balanced stereo inputs and outputs).
- Neutrik EtherCon® Ethernet connection.
- Fully Dante compliant device.
- AES67 compatible.
- Dante Domain Manager compliant.
- Powered via PoE (Power over Ethernet).

## DIO09 Microphone Input to Dante



The AVN-DIO09 is a Microphone input to Dante converter in the Sonifex DIO range of Dante input/output devices with A/D circuitry offering a world-class E.I.N. of 129dB. It features a single high quality mic preamp with balanced XLR input, coarse and fine gain controls, high pass filter, phantom power, tri-colour level LED and one Neutrik EtherCon® connector for direct connection to a Dante AoIP network.

The AVN-DIO09 has coarse and fine mic gain with the coarse gain set using a toggle switch, providing 20dB/50dB of gain, and the fine gain set using a trimmer adjustment tool, or small flat blade screwdriver, adding between 0dB and 36dB of additional gain. An on/off toggle switch turns the high pass filter on or off and when enabled, it acts on frequencies below 125Hz at a rolloff of 6dB/octave.

Phantom power is enabled/disabled via a toggle switch on the front panel and when enabled, a 48V DC supply is provided to power an appropriate microphone. A red LED illuminates to show when phantom is enabled.

A front panel audio level LED helps to set the gain and shows the audio level being sent to the Dante network.

**Note:** If using a phantom powered microphone, it may be necessary to earth the unit using the rear panel earth tag to eliminate mains hum, depending on the nature of your PoE supply.

- 1 x balanced microphone input on XLR socket with latch lock.
- Neutrik EtherCon® Ethernet connection.
- Single turn pot setting fine mic gain (0dB – 36dB).
- Coarse mic gain switch (+20dB/+50dB).
- High pass filter on/off switch.
- Phantom power on/off switch.
- Phantom power LED indicator.
- Level LED indicator.
- Fully Dante compliant device.
- AES67 compatible.
- Dante Domain Manager compliant.
- Ultra-high quality, wide dynamic range A/D conversion.
- Powered via PoE (Power over Ethernet).

## DIORK 19" AVN-DIO Mounting Rack

The AVN-DIORK is a 1U rackmount kit that can accept up to 5 of the smaller AVN-DIO01-9 boxes, or 3 of the AVN-DIO10 boxes. It is supplied complete with AVN-DIO box fixings.



**Please note:** rack comes empty



## AVN-DIO10 Dante® to 3G/HD/SD-SDI Embedder/ De-Embedder

The easiest way to connect legacy SDI equipment to the Dante® network, the AVN-DIO10 can be used for simultaneous embedding and de-embedding. This simple plug and play audio/video interface provides a convenient and elegant method of connecting legacy 3G/HD/SD-SDI equipment to the Dante® AoIP audio network.



AVN-DIO10 Iso View

The AVN-DIO10 takes an SDI feed, de-embeds the 16 audio channels and places them on channels 1-16 of the Dante network, mapped using Dante Controller. It simultaneously takes the 16 input channels mapped to the device on Dante Controller and re-embeds them onto the SDI output.

Switches on the unit allow embedding of Dante channels onto the SDI output per channel pair and there are two modes of operation: Insert Mode enabled allows embedding to overwrite existing SDI audio selectively per channel pair. Insert Mode disabled clears any incoming audio channels on the

SDI output and then allows selective embedding onto the SDI output per channel pair.

A Test Tone Mode allows 1kHz, 2kHz, 3kHz and 4kHz signals to be output on channels 1 to 4 respectively, for any group where embedding is enabled. This is so that downstream SDI audio outputs can be tested without the need of Dante sources.

It's powered using Power over Ethernet (PoE), using Neutrik EtherCON connectors, with primary and secondary ports for power and data redundancy. The AVN-DIO10 uses the latest Audinate Dante® chipsets so is AES67 and Dante Domain Manager® compliant.

There are front panel LEDs to indicate network clock status, SDI lock status, AoIP Primary and AoIP Secondary link status, PoE Primary power and PoE Secondary power active.

A web interface is available for firmware updates, status information and network settings.

The AVN-DIO10 is supplied with a belt-clip, shoulder strap holders (but not the strap) and an underdesk mounting plate. Up to 3 of the AVN-DIO10 units can be rackmount in the 1U AVN-DIORK.



AVN-DIO10 Front View With Cover Plate



AVN-DIO10 Front View Without Cover Plate



AVN-DIO10 Rear View



AVN-DIO10 Attachments: Belt-Clip, Strap Holders & Desk Mounting Plate



AVN-DIO10 With Attachments: Strap Holders & Belt Clip



AVN-DIO10 With Attachments: Strap Holders & Belt Clip



AVN-DIO10 With Attachments: Desk Mounting Plate

- 1 x 3G/HD/SD-SDI input.
- 1 x reclocked 3G/HD/SD-SDI output.
- Dual redundant Primary and Secondary Dante network ports using Neutrik EtherCon® Ethernet connectors.
- Powered via PoE (Power over Ethernet) with PoE dual redundancy.
- Fully Dante compliant device.
- AES67 compatible.
- Dante Domain Manager compliant.
- Web interface for configuration.
- Clock, SDI Lock, PoE and Sync LEDs.
- DIPSwitch selection of embed channel pairs.
- DIPSwitch cover plate to secure selections made.
- Overwrite or insert into existing SDI audio groups.
- Test tones available on embedded outputs.
- SDI audio sample rate support at 48kHz.
- All available Dante sample rates supported.
- Sample rate conversion of audio between Dante and SDI.
- Dante clock domain can be optionally synchronised from the SDI clock.
- Supplied with belt-clip, shoulder strap hooks (but not the strap) and underdesk mounting plate.
- 3 x units rackmount in the AVN-DIORK.

## Technical Specification AVN-DIO10

Parameter SDI Input	
Input Impedance:	75Ω Unbalanced
SDI Supported Standards:	270Mbps SMPTE-259M-C (SD) 1.485 or 1.4835Gbps SMPTE-292M (HD) 2.97 or 2.967Gbps SMPTE-424M (3G)
Supported Video Formats:	525/59.94 (SMPTE-125M) 625/50 (ITU-R BT.656) 720p/23.98, 24, 25, 29.97, 30, 50, 59.94, 60 (SMPTE-296M) 1035i/59.94, 60 (SMPTE-260M) 1080i/50, 59.94, 60 (SMPTE-274M) 1080p/23.98, 24, 25, 50, 59.94, 60 (SMPTE-274M) 1080pSF/23.98, 24, 25, 29.97, 30 (RP-211) 1080i/50 (SMPTE-295M) 1080p/50 (SMPTE-295M)
Embedded Audio:	48kHz, synchronous SMPTE-272M-ABC SMPTE-299M
Supported Image Mapping:	SMPTE-425M-AB
Parameter SDI Output	
Output Impedance:	75Ω Unbalanced
Alignment Jitter:	<0.2UI
Output Level:	800mV ±10%
Return Loss:	<15dB @ 1.5GHz
SDI Supported Standards:	Output follows input
Supported Video Formats:	Output follows input
Embedded Audio:	48kHz, synchronous SMPTE-272M-C SMPTE-299M
Dante	
Parameter	Description
Sample Rates:	44.1kHz, 48kHz, 88.2kHz, 96kHz, 176.4kHz, 192kHz
Encoding:	PCM 16, PCM 24, PCM 32
Equipment Type	
AVN-DIO10:	Dante to 3G/HD/SD-SDI Embedder/De-Embedder
Physical Specification	
Dimensions (Raw):	14.0cm (W) x 13.6cm (D) x 4.2cm (H) 5.5" (W) x 5.4" (D) x 1.7" (H)
Weight:	Nett: 0.5kg Gross: 0.3kg Nett: 1.1lbs Gross: 0.7lbs
Accessories	
AVN-DIORK	AVN-DIO 1U 19" Rack Kit (5 x Small DIO or 3 x Large DIO)

# Dante® Dante® Multi-Channel Audio Interfaces

These new Dante® audio interfaces convert balanced analogue audio line inputs and outputs to Dante AoIP. Simple to configure and operate, these cost effective 1U rack-mount products offer an easy solution for AV professionals and system integrators.

- They are simple to configure and operate, with all set-up done via standard Dante Controller software.
- Using the latest Audinate chipsets, they are AES67 & Dante Domain Manager compliant.
- They are powered via PoE (Power Over Ethernet).
- All analogue connections are on high-quality Neutrik XLR connectors.
- There are front panel status/confidence LEDs for POE, Link, and Clock.
- Connects to the Dante network via a 1Gbps (AVN-AIO8, AVN-AO16) & 100Mbps (AVN-AIO4) RJ45 Ethernet connection.

## AVN-AIO4 4 Input, 4 Output Dante® Interface, PoE



Provides 4 analogue audio inputs and 4 analogue audio outputs on Neutrik XLR connectors.

## AVN-AIO8 8 Input, 8 Output Dante® Interface, PoE



Provides 8 analogue audio inputs and 8 analogue audio outputs on Neutrik XLR connectors.

## AVN-AO16 16 Output Dante® Interface, PoE



Provides 16 analogue audio outputs on Neutrik XLR connectors.

# AVN-GMCS PTPv2 Grandmaster Clock & GPS Receiver



## AVN-GMCS

The AVN-GMCS is a PTPv2 grandmaster clock for use with RAVENNA & AES67 AoIP applications. IEEE1588-2008 PTPv2 (precision time protocol) is used to synchronise all the nodes within a network.

The AVN-GMCS becomes the master clock and distributes time packets using PTPv2 time-stamping to the other nodes on the network, performing this role simply and accurately, enabling sub micro second synchronisation between all nodes.

The unit is configured easily with a responsive embedded webserver, including the setup of the PTP profiles. The AVN-GMCS supports the Default (RAVENNA), Media (AES67) and AES-R16-2016 (SMPTE-ST 2059-2 & AES67 compatible) profiles and has a 'Custom' profile page for you to define your own.

In normal operation, the unit has PTPv2 time stamping resolution to 8nsec. It uses a combination of a GPS receiver, a PLL (phase lock loop) and a specialist on-board clock device to create the precise, low jitter clock signals required to drive the physical transceiver's time stamping circuitry, also providing holdover if the GPS signal is lost.

The specialist on board clock is available in three different types: TCXO, OXCO and CSAC (Chip Scale Atomic Clock, Caesium), which vary in both price and accuracy:

**AVN-GMCS** – TCXO Temp Compensated Oscillator accurate to 1 ppm (1 sec gain/loss per 11.5 days).

**AVN-GMCS** – OXCO Oven Controlled Oscillator accurate to 0.1 ppm (1 sec gain/loss per 115 days).

**AVN-GMCS** – SAC Quantum Atomic Clock accurate to 0.00050 ppm (1 sec gain/loss per 63 years).

GPS presence and the number of satellites received are shown on the front panel, together with status information on output sample rates, sync type and profile type. Some other features include:

- A screen-saver which shows the current time.
- It can slave to a separate clock input.
- Clock outputs can be used to provide media clocks for external equipment. (A single AES-3id output and two outputs which can be selected as either word clock or variable PPS).
- The unit can show UTC or 'local time' on the front panel, by adding a time offset. Daylight saving time changes are accommodated.
- A real time clock allows an accurate date and time even after the unit is repowered without GPS access.
- Front panel LEDs show the synchronisation status, GPS lock and the status of the AC and DC power supply inputs.
- OLED display and LED indicators brightness adjustment.
- 4 GPO indicate critical states for GPS lock status, external sync present, AC power present and DC power present.
- Dual redundant power inputs - an IEC mains input and a 12V DC input.
- Low-power sleep mode available.
- In power off situations, a super capacitor keeps the GPS receiver in a low power mode for more than 20 hours, enabling the receiver to regain lock immediately rather than having to 'cold' start.



# AVN-PXH12 12 x 2 Channel AES67 Stream Mix Monitor



AVN-PXH12

With audio moving to the AoIP network infrastructure allowing hundreds of audio sources to be available on the network, how do you easily monitor them, in a product which is simple to use and without adding complexity?



The AVN-PXH12 is a 24 x AES67 stream input mixer monitor in a 1U rack frame.

The main benefit over traditional monitors is the speed with which sources can be monitored. Each unit has front panel headphone outputs and a speaker, together with rear panel analogue outputs. There are 12 x mini channel-strips along the front panel, each with a translucent rotary encoder showing confidence monitoring of the input level in the knob itself and output mix level in the LEDs around the encoder. Three buttons for each encoder can be used to select the main/secondary input, to mute the channel and to send the audio of that channel to left, right or stereo mix of the output. Pressing the encoder knob lets you solo the channel. With these simple controls, a mix of any of 24 channels can be made quickly and intuitively, ideal for live news environments where audio sources are changing rapidly and need to be monitored instantly.

As well as monitoring any AES67 AoIP stream, SAP discovery has been added to the unit so that AES67 Dante® streams can also be mixed and monitored. Additionally, Ember+ is used for the control communication allowing remote control of the product using the open Ember+ standard.

## Mix Monitor Features:

- AES67 is an established AoIP stream format – the unit uses RAVENNA audio to ensure AES67 compatibility.
- A built-in web server is used for all configuration. Sources for all channels are simply assigned on one webpage.
- SAP is used as a discovery mechanism to discover Dante® devices and monitor Dante® AES67 streams. Dante® is a trademark of Audinate Pty Ltd.
- Confidence monitoring on the translucent volume knob for each channel so you've got 'at-a-glance' monitoring available.
- The front panel Mute button and the Solo feature on the control knob allow a single channel, or a handful of, channels to be auditioned quickly.
- For each channel, 'Normal' and 'Alternate' inputs can be switched quickly (with <1msec accuracy) for direct comparison.
- Each channel can be directed to headphone left ear, right ear, or a stereo mix.
- 6.35mm (1/4") & 3.5mm headphone outputs and a speaker output with separate LS & HP volume controls.
- Speaker mute button.
- Sources from AoIP, balanced or 3 x unbalanced inputs.
- Destinations to AoIP or 3 rear panel balanced outputs.
- The unit also sends to the network, as AoIP AES67 streams, the 8 channels of the 4 physical stereo inputs, together with a stereo mix of the speaker output.
- Dual 1Gb lan ports & 1Gb SFP fibre port.
- 10 user assignable GPIO ports as inputs or outputs.
- Dual redundant AC & DC power supply inputs.

# AVN Portals - Multi-Channel Audio Mix Engine Interfaces Using AES67 AoIP

These are a range of 3 audio interface portals which mix and route analogue, AES3, microphone & AES67 stream inputs to analogue, AES3 & AES67 outputs.

**Analogue** AVN-PA8, 8 x Stereo Analogue Line Inputs & 8 x Stereo Analogue Outputs

**AES3 Digital** AVN-PD8, 8 x Stereo AES3 Digital Inputs & 8 x Stereo AES3 Outputs

**Microphone** AVN-PM8, 8 x Mic/Line Inputs & 8 x Stereo Analogue Outputs

Each of the portals can be ordered either with the input/output metering displays (D version) or without and there are two options for rear panel connectivity - with XLR/RJ45 connectors or terminal block (T version) connectors.

The heart of each portal is the web-enabled mix engine. Any physical input and AES67 stream input can be mixed or routed to any physical output or AES67 stream output, with gain alteration at the input, the mix point or the output. Up to 16 x AES67 input channels and 64 x AES67 output channels can be created in each portal, supporting the full range of AES67 packet times and channel counts.

With this flexibility, the portals become advanced problem-solving boxes, allowing them to be used for any applications where monitoring of inputs and outputs, and mixing of signals is required. In addition, supporting native AES67, multiple stream outputs can be provided and this is combined with remote handling via GPIO, VGPIO, SNMP and Ember+ support.

The portals' versatility allows them to be used for any applications where mixing of signals is required.

Example applications include:

- 8 stereo channel cleanfeed generator.
- Send 64 streams of IFB to connected belt-packs.
- 8 output zone mixer.
- Input mixer with input/output metering and stream AES67 generation.
- Multi-channel mic mixer.
- Distribute 8 stereo channels of audio over an SFP fibre connection.
- Headphone distribution system, with separate feeds to each headphone output. The output connections are capable of supplying analogue power to satellite headphone amplifiers, the AVN-HA1 and AVN-HD1.

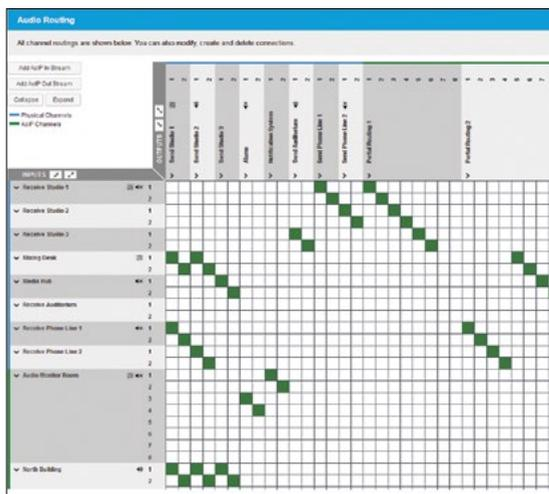

'Audio Routing' Webpage

## AVN Portal Features:

All of the portals have the following feature-set:

- Responsive webserver software mixer/router to mix any input to any output.
- 'T' version has audio I/O on terminal blocks.
- 'D' version has input & output metering on bright front panel displays, with 9 metering types and channel idents.
- Up to 8 AoIP AES67 input streams with a maximum of 16 input channels to be routed.
- Up to 8 AoIP output channels with a maximum of 8 channels each, providing up to 64 stream outputs.
- Input/output full-scale line-up.
- Input and output gain adjustment.
- SNMP V2 - Gets, Sets & sending traps.
- Ember+ remote control.
- Dual 1Gb Ethernet & 1Gb SFP ports.
- Dual AC & DC power supply inputs.
- 10 user assignable GPIO ports and relay output.

## AVN-PA8 8 x Stereo Analogue Line Inputs & Outputs, AES67 Portal



AVN-PA8D & AVN-PA8TD

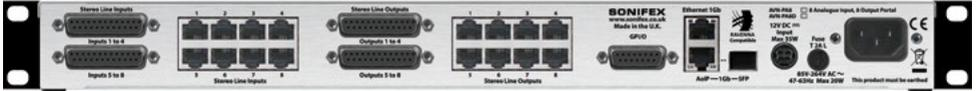

AVN-PA8 & AVN-PA8D

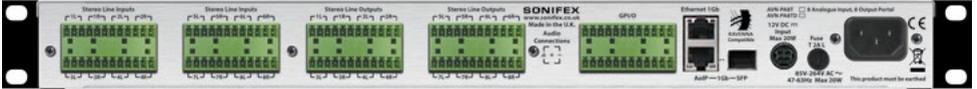

AVN-PA8T & AVN-PA8TD

**The AVN-PA8 has 8 stereo line inputs and 8 stereo line outputs on D-type sockets with AES59 analogue pinout, paralleled with 16 x RJ45 connectors using StudioHub® pinout.**

**Applications Include:**

- 8 output analogue zone mixer, with individual output gain control.
- 8 channel clean-feed generator, with input mixing and gain control on inputs and outputs.
- Distribute 8 stereo channels of audio over an SFP fibre connection.
- IFB generator to send 64 x AES67 streams to individual belt-packs.
- 8 output headphone distribution system, with separate input mix for each headphone output and individual gain control.
- Input mixer with input/output metering and AES67 stream generation.

**Equipment Type**

- AVN-PA8:** 8 Stereo analogue line inputs & 8 stereo analogue line outputs, AES67 portal.
- AVN-PA8D:** 8 Stereo analogue line inputs & 8 stereo analogue line outputs, AES67 portal, with detailed meter displays.
- AVN-PA8T:** 8 Stereo analogue line inputs & 8 stereo analogue line outputs on terminal blocks, AES67 portal.
- AVN-PA8TD:** 8 Stereo analogue line inputs & 8 stereo analogue line outputs on terminal blocks, AES67 portal, with detailed meter displays

**Webserver Software**

A built-in responsive web server provides complete remote configuration & control of the unit including matrix mixing and routing, and also allows for firmware updates and configuration backup. Complete product configurations can be saved and loaded for use in different situations and system logs can be saved for device information.

**Mix Matrix**

The key to the success of the AVN-PA8 is the mix matrix where physical inputs can be freely mixed and routed with AES67 streams, in a simple and intuitive way to both physical outputs and AES67 streams. The unit can stream RAVENNA & AES67 AoIP streams or AES67-enabled Dante® flows (discovered using SAP). It can receive AoIP streams from 16 additional AES67 sources and can send to 64 additional AoIP destinations.

Input and output AES67 streams can be individually added/modified and the SDP of each stream can be checked and edited. DSP functions, such as gain and filtering, can be added at inputs, outputs and cross-points.

The unit can act as a PTP masterclock or slave clock and supports IEEE1588-2008 PTPv2 media and default profiles.

**Front Panel Displays, Metering & Controls**

The AVN-PA8 can be supplied with different front and rear panels. As standard it has a front panel display to show product information and it uses XLRs and D-types for rear panel connectivity. **(Continued)...**

## AVN-PD8 8 x Stereo AES3 Digital Inputs & Outputs, AES67 Portal



AVN-PD8 & AVN-PD8T



AVN-PD8 & AVN-PD8D

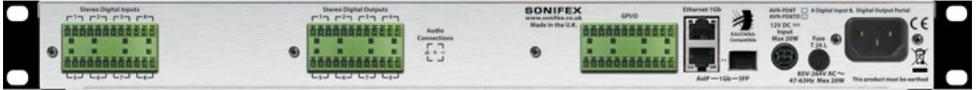

AVN-PD8T & AVN-PD8TD

The AVN-PD8 has 8 x stereo digital AES3 inputs and 8 x stereo digital AES3 outputs on D-type sockets with AES59 pinout, paralleled with 16 x RJ45 connectors using StudioHub® pinout. There is individual input sample rate conversion.

### Applications Include:

- 8 channel digital mixer.
- Distribute 8 stereo AES3 channels of audio over an SFP fibre connection.
- IFB generator to send 64 x AES67 streams to individual belt-packs.
- 8 output headphone distribution system on AES3, with separate input mix for each headphone output and individual gain control.

### Equipment Type

**AVN-PD8:** 8 Stereo AES3 digital inputs & 8 stereo AES3 digital outputs, AES67 portal.

**AVN-PD8D:** 8 Stereo AES3 digital inputs & 8 stereo AES3 digital outputs, AES67 portal, with detailed meter displays.

**AVN-PD8T:** 8 Stereo AES3 digital inputs & 8 stereo AES3 digital outputs on terminal blocks, AES67 portal.

**AVN-PD8TD:** 8 Stereo AES3 digital inputs & 8 stereo AES3 digital outputs on terminal blocks, AES67 portal, with detailed meter displays.

### ...Front Panel Displays (Continued)

Using an OLED display, the front panel provides detailed status information on device name, network addresses, PTP clocking info, power status/voltages and version information. The display and navigation controls allow editing of certain functions, limited to networking (IP addresses, friendly name, etc) and display (brightness and contrast). The front panel controls also include user configurable buttons which can be set-up to perform actions such as activating a GPIO or as a shortcut button to jump to a specified menu on the OLED display.

Front panel LEDs show the AoIP network status, synchronisation status and the status of the AC and DC power supply inputs. The brightness of the OLED display and LED indicators can be continuously adjusted for low or high lighting conditions.

A front panel power button is available to turn the unit on and off. The power button is disabled by default but can be enabled through the 'Display Settings' web page.

### Detailed Metering Option

The 'D' version of the portal (e.g. AVN-PA8D) has two bright TFT meter displays which provide a live display of the levels of the physical inputs and outputs respectively. **(Continued)...**

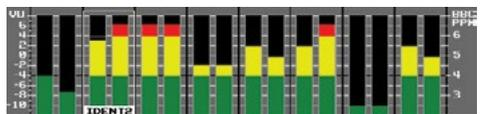

Summary Input Levels Meter Display, Continuous Mode



## AVN-PM8 8 x Mic/Line Inputs & 8 x Line Outputs, AES67 Portal



AVN-PM8 & AVN-P8T



AVN-PM8 & AVN-PM8D

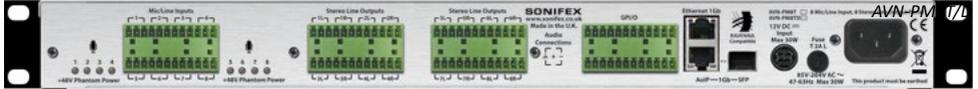

AVN-PM8T & AVN-PM8TD

The AVN-PM8 has 8 x mic/line inputs on XLR sockets and 8 stereo line outputs on D-type sockets with AES59 analogue pinout, paralleled with 8 x RJ45 connectors using StudioHub® pinout. There are 8 x 3mm red LED phantom presence indications and each channel has additional mic pre-amp gain adjustment.

### Applications Include:

- 8 channel microphone input mixer, with individual output gain control, input/output metering and AES67 stream generation.
- 8 channel clean-feed generator, with input mixing and gain control on inputs and outputs.
- Distribute 8 microphone channels of audio over an SFP fibre connection.
- 8 output headphone distribution system, with separate input mix for each headphone output and individual gain control.

### Equipment Type

- AVN-PM8:** 8 Mic/line inputs, 8 stereo analogue line outputs, AES67 portal.
- AVN-PM8D:** 8 Mic/line inputs, 8 stereo analogue line outputs, AES67 portal, with detailed meter displays.
- AVN-PM8T:** 8 Mic/line inputs, 8 stereo analogue line outputs on terminal blocks, AES67 portal.
- AVN-PM8TD:** 8 Mic/line inputs, 8 stereo analogue line outputs on terminal blocks, AES67 portal, with detailed meter displays.

### ...Detailed Metering Option (Continued)

The rotary navigation control allows selection of a single input/output in a more detailed horizontal view.

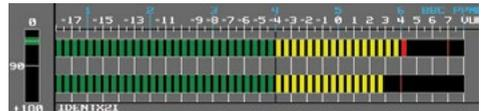

Detailed Discrete Metering

Detailed Continuous Metering

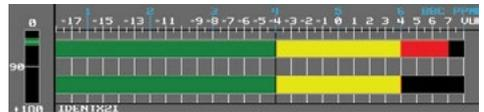

The metering scale used is user configurable to one of 9 different metering scales, with relevant ballistics.

Phase metering can be displayed per stereo channel and channel idents can be shown either above or below the metering to identify each input/output.

On Portals without the meter displays, the main OLED display shows a set of monochrome meters.

There are two Ethernet RJ45 connections (control and AoIP) and there is an Ethernet SFP module that, when used, replaces the AoIP RJ45 connection, e.g. for a 1Gbit/s copper or optical SFP transceiver.

A rear panel GPIO connector provides 10 local ports which can be user configured as inputs or outputs providing software-controlled functionality. A voltage free relay contact can operate external equipment. Virtual GPIO ports can be used to trigger events over the network between devices.

The rear panel contains IEC mains and secondary DC power inputs which provide power redundancy.

# Headphone Distribution System

The AVN Portals can be combined with the Sonifex AVN-HA1 and AVN-HD1 headphone amplifiers to create a headphone distribution system where each headphone amplifier can be sent a separate feed, mixed from any physical or AES67 stream inputs.

On portal units with RJ45 outputs, an AVN-HA1 (for the AVN-PA8 and AVN-PM8) or AVN-HD1 (for the AVN-PD8) headphone amplifier can be used to listen to the outputs, with the portals providing power and audio signals.

The switches on the front panel of the AVN-HA1 and AVN-HD1 can be used as another GPI for example, for muting the output.

**Headphone Distribution System Using Analogue Portal & 8 x AVN-HA1 Units**

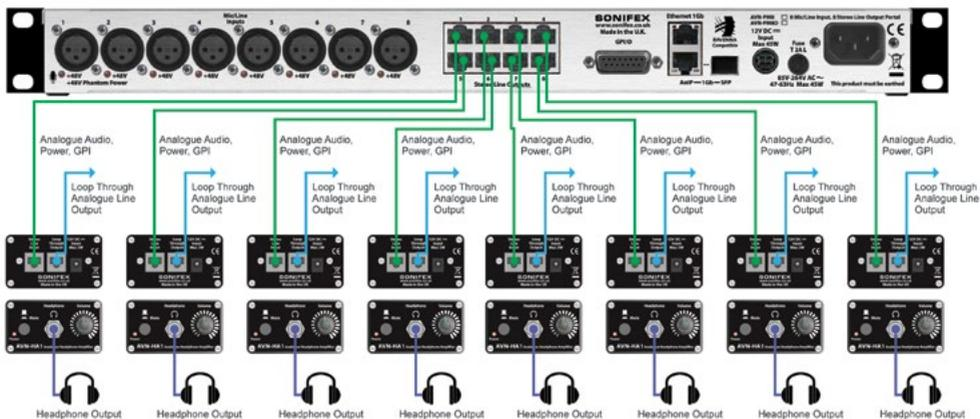

## AVN-HA1 Analogue Headphone Amplifier for AVN-PA8/D & AVN-PM8/D Portals



- Front panel 6.35mm (1/4") headphone socket and volume control knob, with Mute/GPO push button.
- Analogue audio input on RJ45 (the connector provides power to the unit and a GPO back to the portal).
- Loop through audio output on RJ45 (power and GPO signal are not connected).
- Locking DC power connector if a portal is not being used to supply the unit with power.

## AVN-HD1 Digital Headphone Amplifier for AVN-PD8/D Portals



- Front panel 6.35mm (1/4") headphone socket and volume control knob, with Mute/GPO push button.
- AES3 digital input on RJ45 (the connector provides power to the unit and a GPO back to portal).
- AES digital output on RJ45 (power and GPO signal are not connected).
- Locking DC power connector if a portal is not being used to supply the unit with power.

# Talkback Intercom System Using AES67 AoIP

The new range of AVN talkback/listening/paging intercoms aid communication between studios, stages, theatres, offices and different areas in a facility or building complex.

The system doesn't use a central router – each unit is intelligent and can talk to other intercoms connected to the same network.

With both 4-wire analogue inputs and outputs, as well as AES67 AoIP network audio connectivity, the AVN-TB units can be used

with existing legacy 4-wire systems and with new AES67 AoIP infrastructure.

All audio is at 48kHz sample rate, meaning that it's broadcast quality audio as standard.

Also, connections can be made to AES67 streams, as well as Sonifex devices, with GPIO or VGPIO tallies used for signalling.

Simple responsive webserver configuration with Ember+ remote control.

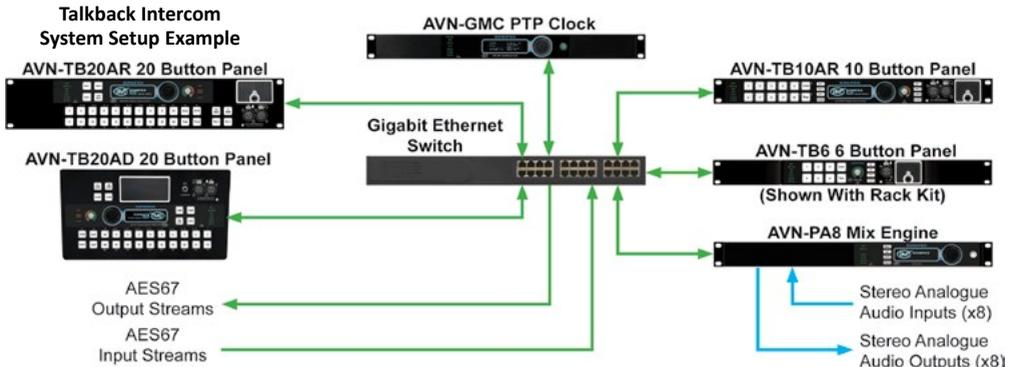

## AVN-TB6 6 Button Talkback Intercom

The AVN-TB6 is a 6 channel talkback intercom control unit from the Sonifex AVN range of IP based products. The AVN-TB6 is a freestanding version which can be rackmounted with the AVN-TB6RK 1U rack kit.

This unit provides broadcast quality audio communication between studios, offices and different areas in a facility or building complex, using RAVENNA/AES67 as the transport mechanism, allowing simple CAT 5 cabling and expansion. RAVENNA (of which AES67 is a subset) allows for the distribution of audio across a network. The AVN range use RAVENNA as the communication method providing compatibility with other AES67 systems.

Each of the 6 channels on the AVN-TB6 can be configured to provide communications with other remote networked units, and an independently configurable 'page' function can contact selected units with priority over standard intercom calls if required.



AVN-TB6

- 6 illuminated key-cap Talk buttons plus Listen & Page buttons.
- Mic & headset inputs, headphone & speaker outputs with volume control.
- Loudspeaker & Mic Mute buttons.
- Dual AC & DC power supply inputs.
- Advanced echo cancellation & mic AGC to prevent acoustic feedback.
- 10 user assignable GPIO ports.
- Dual 1Gb Ethernet & 1Gb SFP port.
- Responsive design Ethernet webserver.
- AVN-TB6RK 19" rack kit available.

## AVN-TB6D 6 Button Desktop Talkback Intercom

The AVN-TB6D is a desktop version of the AVN-TB6 intercom with a smaller form factor and an elegant sloped front. It has the same feature set and connectivity.



AVN-TB6D

- 6 illuminated key-cap Talk buttons.
- Listen & Page buttons.
- User definable button.
- Speaker & microphone mute buttons.
- Mic & headset inputs, with +48V phantom power for the mic inputs.
- Headphone & speaker outputs.
- Front panel volume control which operates on speaker headphone outputs and incoming source levels.
- Sources and destinations from/to AoIP.
- Advanced echo cancellation & mic AGC to prevent acoustic feedback.
- Front panel monitor button for routing audio directly to the speaker e.g. to take an IFB feed or off-air transmission signal.
- Ducking or mixing of inputs.

## AVN-TB20AR 20 Button Advanced Rackmount Talkback Intercom

The AVN-TB20AR is a 2U rackmount version of the AVN-TB10AR with the same specification, but 20 station buttons allowing greater communication for larger facilities.



AVN-TB20AR

- 20 illuminated key-cap Talk buttons plus Listen & Page buttons.
- Group Talk with up to 3 user defined groups.
- Phone button for remote dialling and control of an external telephone hybrid.
- Dual 1Gb Ethernet & 1Gb SFP port.
- Mic & headset inputs (front & rear panel headset connection), headphone & speaker outputs.
- Dual AC & DC power supply inputs.
- Sources from AoIP, 1 x balanced, 2 x unbalanced and S/PDIF digital inputs.

## AVN-TB20AD 20 Button Advanced Desktop Talkback Intercom



AVN-TB20AD

The AVN-TB20AD is a 20 channel desktop version of the AVN-TB20AR talkback intercom.

- 20 illuminated key-cap Talk buttons plus Listen & Page buttons.
- Callback button with callback source display.
- Three user definable buttons.
- Speaker & microphone mute buttons.
- Mic & headset inputs, headphone & speaker outputs.
- Front panel volume control which operates on speaker/headphone outputs and incoming source levels.
- +48V phantom power for the mic inputs.
- Advanced echo cancellation & mic AGC to prevent feedback.

## AVN-TB10AR 10 Button Advanced Rackmount Talkback Intercom



AVN-TB10AR

**The AVN-TB10AR is the flagship of the AVN-TB range providing an advanced feature-set with unparalleled audio quality. A superb acoustic echo cancellation algorithm allows units to be placed next to each other with open mics and no feedback. Low latency, broadcast quality audio comes as standard, using RAVENNA AES67.**

The AVN-TB10AR is a 10 button intercom meaning that 10 other 'stations' can be defined, one per button, for communication. Comms can be made as a Talk action, a Listen action, a Talk with Forced Listen action or a duplex Talk/Listen action to/from each station. Coloured LEDs in the buttons help to show which action is being used and there is also a Callback button for when you're unavailable to receive a call.

The stations can be from anywhere on the AoIP network and the use of Bonjour Device Discovery means that other stations can be found quickly and sometimes automatically. The talkback source can also be any stream on the network, using GPIO and VGPIO for call control, if required. Also, a new 4W Bridge Mode offers an alternative to normal intercom use, allowing audio equipment connected to local inputs and outputs to communicate with remote devices assigned to the channel buttons.

The Page button is used to speak to all stations (or a defined list of stations) and Group Talk functions can be enabled to page particular groups of stations.

Two monitor buttons allow for routing audio directly to the speaker e.g. to take an IFB feed or an off-air transmission signal. Signals can be ducked or mixed when a talkback input is received to the speakers or headphones.

Three user defined buttons can be programmed for different functions, such as for Group Talk.

The speaker mutes automatically when headphones are inserted and the volume level of headphones, speaker and incoming sources can all be controlled with one front panel rotary encoder volume control.

Advanced acoustic echo cancellation & built-in mic AGC (automatic gain control) ensure that there's no acoustic feedback between microphone and speaker.

Microphone mute (cough) and speaker mute buttons can be controlled remotely by GPI or Ember+.

Each unit has a built-in webserver which is where the majority of settings and configurations are made. The webserver is a responsive design meaning that it can be used with small screens on smartphones and tablets. Front panel LEDs show the AoIP network status, synchronisation status, whether AGC is being used and the status of the AC and DC power supplies.

### AVN-TB10AR Features:

- 10 illuminated key-cap Talk buttons plus Listen & Page buttons.
- Mic & headset inputs, headphone & speaker outputs with volume control.
- Sources from AoIP, balanced, 2 x unbalanced or S/PDIF digital inputs.
- Destinations to AoIP or rear panel balanced & unbalanced outputs.
- Advanced echo cancellation & mic AGC to prevent acoustic feedback.
- Dual 1Gb lan ports & 1Gb SFP fibre port.
- 10 user assignable GPIO ports and relay output.
- Dual AC & DC power supply inputs with LED indication and GPO/VGPO notifications.
- Front panel display providing source & destination information.
- Ethernet webserver and front panel control & configuration.
- Speaker & microphone mute buttons.

# Presenter In-Ear Monitoring System Using AES67 AoIP

An 8 x 4 channel mix engine forms the central core of a powerful presenter in-ear monitoring system, allowing up to 32 Presenter Remote controllers to alter the mix output levels of 1 of 8 virtual mixers (VMs), each with 4 mono channels.

Technician Remote units can oversee all VMs, adjusting the level of the 4 mono inputs of each VM in case presenters are busy, or for total remote operation.

## In-Ear Monitoring System Overview 1

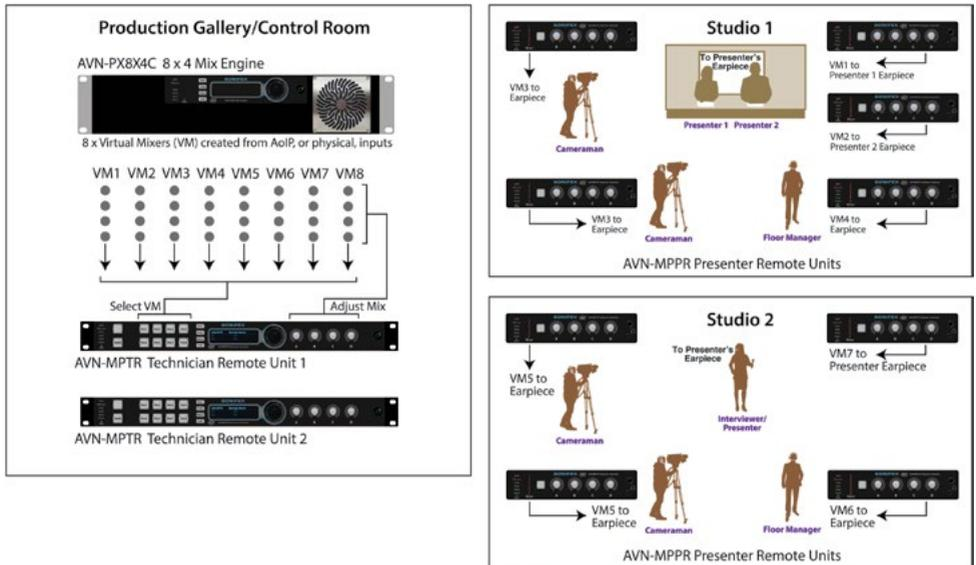

## AVN-MPPR 4 Channel Presenter In-Ear Monitoring Remote Controller, AES67



### AVN-MPPR

The presenter remote controller provides the mixed audio to the presenter's earpiece via front panel 1/4" & 3.5mm headphone outputs, together with a rear panel XLR output.

The four rotary encoders control the 4 channels of a selected virtual mixer, and can switch between visual

feedback for both mix level of the source and actual input level by pressing the encoder.

Up to 32 units can be connected to a mix engine. Multiple units can simultaneously control any of the 8 virtual mixers in the main mix engine with the VM number displayed on the front panel.

Audio is transported from the mix engine to the remote units using AES67 AoIP with a single PoE Neutrik™ Ethercon network connection. A front panel button can be used to actuate one of the ten GPIO pins.

Units can be mounted on a standard microphone screw thread or under a desktop using optional accessories.

## AVN-MPTR Technician Remote Controller



### AVN-MPTR

- Allows selection of each of 8 x VMs and remote adjustment of mix output volumes.
- 8 virtual mixer select buttons.
- 4 x rotary encoders showing input level metering and output volume control.
- GPO enable and activation buttons.

### In-Ear Monitoring System Overview 2

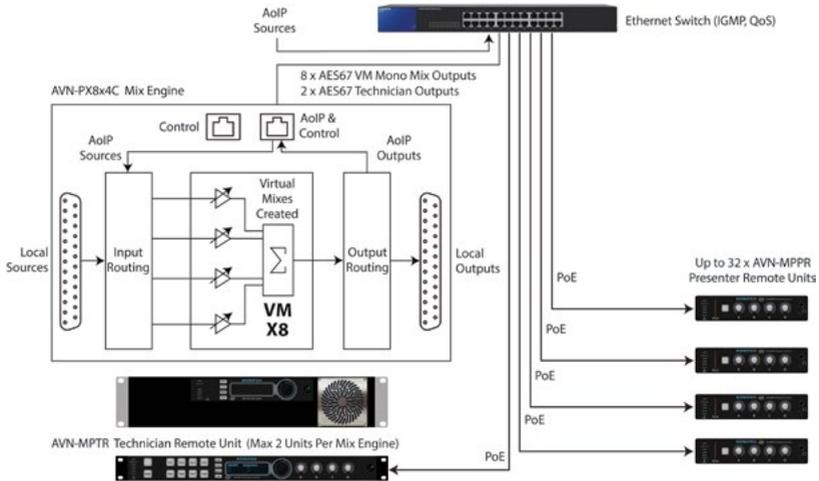

## AVN-PX8X4C 8 x 4 Channel Mix Engine, 24 Inputs, 16 Outputs, AES67

The mix engine houses the hardware where the complex routing, mixing and DSP functions are performed. This resilient 2U rack has dual hot-swappable AC power supplies and both 1Gb Ethernet & SFP ports.



AVN-PX8X4C

- 8 virtual mixers, each with 4 mono channel inputs to one mono output AES67 stream.
- Virtual mixers controlled by connected technician and presenter remote controls.
- 24 analogue inputs and 16 analogue outputs on D-type connectors.
- 32 logical inputs & 10 logical outputs using AoIP.
- Sophisticated configuration via webserver.
- Dual hot-swappable AC power supplies.

### Sonifex Ltd

61 Station Road, Irthlingborough,  
Northants, NN9 5QE, UK  
T: +44 (0) 1933 650700  
F: +44 (0) 1933 650726  
E: sales@sonifex.co.uk  
W: www.sonifex.co.uk

### Sonifex Pty Ltd

12/6 Leighton Place Hornsby  
NSW 2077 AUSTRALIA  
T: +61 2 9987 0499  
F: +61 2 9476 4950  
E: sales@sonifex.com.au  
W: www.sonifex.com.au