

OPERATION MANUAL

MFR-RU Series

MFR-16/40RU
MFR-16RUD
MFR-16/32/64RUW
MFR-18RU/RUA
MFR-39RU/RUA
MFR-16RUTA
MFR-8RUA

Remote Control Unit

3rd Edition





Edition Revision History

Edit.	Rev.	Date	Description	Section/Page
1	-	2017/08/23	First edition	
2	-	2018/02/09		Throughout
3	-	2019/02/06	Added MFR-8RUA Added remote controller setting menu in the Web-Based Control	Throughout Secs. 2 and 4



Precautions

Important Safety Warnings



[Power]

 Caution	Operate unit only at the specified supply voltage.
 Caution	Disconnect the power cord via the power plug only. Do not pull on the cable portion.
 Stop	Do not place or drop heavy or sharp-edged objects on the power cord. A damaged cord can cause fire or electrical shock hazards. Regularly check the power cord for excessive wear or damage to avoid possible fire / electrical hazards.
 Caution	Ensure the power cord is firmly plugged into the AC outlet.

[Grounding]

 Caution	Ensure the unit is properly grounded at all times to prevent electrical shock.
 Hazard	Do not ground the unit to gas lines, units, or fixtures of an explosive or dangerous nature.



[Operation]

 Hazard	Do not operate the unit under hazardous or potentially explosive atmospheric conditions. Doing so could result in fire, explosion, or other hazardous results.
 Hazard	Do not allow liquids, metal pieces, or other foreign materials to enter the unit. Doing so could result in fire, other hazards, or a unit malfunction.
 Caution	If a foreign material does enter the unit, turn the power off and immediately disconnect the power cord. Remove the material and contact an authorized service representative if damage has occurred.

[Transportation]

 Hazard	Handle with care to avoid impact shock during transit, which may cause malfunction. When you need to transport the unit, use the original or suitable alternative packing material.
---	--

[Circuitry Access]

	<p>Do not remove covers, panels, casing, or access the circuitry with power applied to the unit. Turn the power off and disconnect the power cord prior to removal. Internal servicing / adjustment of unit should only be performed by qualified personnel.</p>
 <p>Stop</p>	<p>Do not touch any parts / circuitry with a high heat factor. Capacitors can retain enough electric charge to cause mild to serious shock, even after the power has been disconnected. Capacitors associated with the power supply are especially hazardous.</p>
 <p>Hazard</p>	<p>Unit should not be operated or stored with cover, panels, and / or casing removed. Operating the unit with circuitry exposed could result in electric shock / fire hazards or a unit malfunction.</p>

[Potential Hazards]

 <p>Caution</p>	<p>If abnormal odors or noises are noticed coming from the unit, immediately turn the power off and disconnect the power cord to avoid potentially hazardous conditions. If problems similar to the above occur, contact an authorized service representative before attempting to operate the unit again.</p>
--	---

[Rack Mount Brackets, Ground Terminal, and Rubber Feet]

 <p>Caution</p>	<p>To rack-mount or ground the unit, or to install rubber feet, do not use screws or materials other than those supplied. Doing so may cause damage to the internal circuits or components of the unit. If you remove the rubber feet that are attached to the unit, do not reinsert the screws that secure the rubber feet.</p>
--	--

[Consumables]

 <p>Caution</p>	<p>Consumable items that are used in the unit must be periodically replaced. For further details on which parts are consumables and when they should be replaced, refer to the specifications at the end of the Operation Manual. Since the service life of the consumables varies greatly depending on the environment in which they are used, such items should be replaced at an early date. For details on replacing consumable items, contact your dealer.</p>
--	---

Upon Receipt

MFR-RU Series units and their accessories are fully inspected and adjusted prior to shipment. Check your received items against the packing list below. Check to ensure no damage has occurred during shipment. If damage has occurred, or items are missing, inform your supplier immediately.

◆ Remote Control Unit

ITEM	QTY	REMARKS
MFR-16/40RU MFR-16RUD MFR-16/32/64RUW MFR-18RU/RUA MFR-39RU/RUA MFR-16RUTA MFR-8RUA	1	
AC cable	1	
AC Adaptor ^(*)	1	With DC lock plug (MFR-40RU/39RUA/18RUA/8RUA)
DC cable retaining clip	1 set	For AC adapters w/o DC lock plug
Rack Mount Brackets	1 set	EIA standard type (MFR-16/32/64RUW/16RUTA is supplied w/o Rack Mount Brackets.)
Tool used to change button labels	1	
LAN Cable (straight) ^(**)	1	MFR-39/40/18RU/16RUTA/18RUA/39RUA/8RUA: UTP cable, 3m MFR-16RU/16RUD: STP cable, 3m (MFR-16/32/64RUW is supplied w/o LAN Cable.)

^(*) Depending on the production date, AC adapters are supplied without DC lock plugs, but with DC cable retaining clips.

^(**) User-prepared LAN cables are able to be used. Shielded Twist Pair cables are recommended for MFR-16RU/16RUD/16RUW/32RUW/64RUW.

MFR-8RUA Option

Rack Mount Brackets	1 set	EIA standard type for one or two units.
---------------------	-------	---

Installing the DC Cable Retaining Bracket

Install the supplied retaining bracket onto the rear panel of devices, such as a Control Unit as shown below.

1) Bundle the cable with the supplied clip.

2) Secure the clip with the supplied screw.

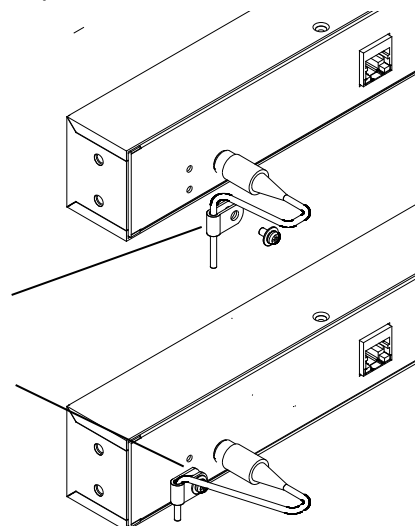

Table of Contents

1. Prior to Starting.....	9
1-1. Overview	9
1-2. Features	9
2. Setup	10
2-1. Connecting to Web-Based Control	10
2-2. Assigning Functions to Buttons.....	11
3. Panel Descriptions.....	12
3-1. Front Panel.....	12
3-2. Rear Panel	15
4. Web-Based Control	17
4-1. Assign Function.....	17
4-2. RU Info	20
4-3. RU Settings	21
4-3-1. Saving and Loading the Settings File	23
4-4. Src/Dest-Inhibit.....	23
4-5. Salvo	24
5. Remote Control Unit Operation	25
5-1. Function and Operation.....	25
5-2. Basic Operations	26
5-2-1. Operating Buttons	26
5-2-2. Switching Pages	26
5-2-2-1. Switching Pages per Group.....	27
5-2-3. Level Control.....	29
5-2-3-1. Displaying Levels on the Remote Control Unit.....	30
5-2-4. Operating with CONTROL (Rotary Selector).....	30
5-3. Function Buttons	33
5-4. MODE Button and Mode Menu (MFR-18RU/18RUA/39RU/39RUA/16RUTA/8RUA)	36
5-4-1. Outline.....	36
5-4-2. Mode Menu	37
5-4-3. Setting Mode Menu (MFR-39RU)	39
5-4-3-1. NAME TYPE	40
5-4-3-2. BTN ASSIGN.....	41
5-4-4. Setting Mode Menu (MFR-39RUA).....	42
5-4-4-1. NETWORK	43
5-4-4-2. VER/ALARM.....	44
5-4-4-3. DEFAULT	44
5-4-4-4. BUTTON ASSIGN	45
5-4-4-5. INHIBIT	46
5-4-4-6. NAME TYPE	47
5-4-4-7. BRIGHTNESS	47
5-4-4-8. RU-RU CONNECT	47
5-4-4-9. TENKEY	48
5-4-4-10. PAGE.....	48
5-4-4-11. SALVO CLEAR.....	48
5-5. Operation Using the Menu Display (MFR-16RUD).....	49
5-5-1. Crosspoint Switching	49
5-5-2. Changing Button Assignment	50
5-6. Setup Menu (MFR-16/40RU, MFR-16RUD, MFR-16/32/64RUW)	52
5-6-1. Displaying Network Settings	53
5-6-2. Changing the RU IP Address.....	54
5-6-3. Rebooting MU PC-LAN.....	55
5-7. Setup Menu (MFR-18RU/18RUA)	56

5-7-1. Displaying Network Settings	56
5-7-2. Changing the RU Network Settings	57
5-7-3. Rebooting MU PC-LAN.....	57
5-8. Setup Menu (MFR-39RU)	58
5-8-1. IP ADDRESS [RU]	58
5-9. Setup Menu (MFR-39RUA).....	59
5-10. Setup Menu (MFR-16RUTA)	59
5-10-1. Displaying Network Settings	60
5-10-2. Changing the RU Network Settings	60
5-10-3. Rebooting MU PC-LAN.....	61
5-11. Setup Menu (MFR-8RUA).....	61
5-11-1. Displaying Network Settings	62
5-11-2. Changing the RU Network Settings	62
5-11-3. Rebooting MU PC-LAN.....	63
5-12. Multi-Panel Operation	64
5-12-1. Outline.....	64
5-12-2. Enabling Multi-Panel Operation	65
6. Crosspoint Control.....	66
6-1. Single Crosspoint Switching	66
6-1-1. Single Crosspoint Switching by X-Y Setting	66
6-1-1-1. SKIP-FWD/BWD.....	67
6-1-1-2. TENKEY (MFR-39RU/39RUA).....	67
6-1-2. A Crosspoint Switching Using a Bus Button	68
6-1-3. CHOP Function.....	69
6-1-4. Crosspoint Switching Using TAKE Function.....	69
6-2. Simultaneous Crosspoint Switching.....	70
6-2-1. Main Unit Stored Salvos	70
6-2-2. Remote Control Stored Salvos	70
6-2-3. Simultaneous Switching Using the Take Function	72
6-2-4. Simultaneous Switching by the Link Function	72
6-3. Lock.....	72
6-3-1. LOCK LOCAL	72
6-3-2. LOCK OTHER / LOCK ALL	73
6-4. Monitor Output Function (MFR-5000/8000)	75
6-5. Preview Function.....	76
7. Troubleshooting.....	76
7-1. Tuning the Text Color on Remote Unit Buttons	77
7-1-1. MFR-18RU/39RU Color Tuning Procedure	77
7-1-2. MFR-39RUA/18RUA/16RUTA/8RUA Color Tuning Procedure.....	78
8. Specifications and Dimensions	79
8-1. Unit Specifications.....	79
8-1-1. MFR-16RU/16RUD	79
8-1-2. MFR-40RU.....	79
8-1-3. MFR-16RUW	80
8-1-4. MFR-32RUW	80
8-1-5. MFR-64RUW	80
8-1-6. MFR-18RU.....	81
8-1-7. MFR-18RUA	81
8-1-8. MFR-39RU.....	82
8-1-9. MFR-39RUA	82
8-1-10. MFR-16RUTA	83
8-1-11. MFR-8RUA	83
8-2. External Dimensions	84
8-2-1. MFR-16RU.....	84

8-2-2. MFR-40RU	84
8-2-3. MFR-16RUD	85
8-2-4. MFR-16RUW	85
8-2-5. MFR-32RUW	86
8-2-6. MFR-64RUW	86
8-2-7. MFR-18RU.....	87
8-2-8. MFR-18RUA	87
8-2-9. MFR-39RU.....	88
8-2-10. MFR-39RUA	88
8-2-11. MFR-16RUTA	89
8-2-12. MFR-8RUA	89
Appendix: Operation Tips	90
How to use Page buttons	90

1. Prior to Starting

1-1. Overview

We offer several types of MFR series remote control units to suit your application. A maximum of 128 units can be connected, including the main unit. This lets you build a flexible control environment by the way you partition the matrix and operation level settings are configured.

1-2. Features

◆ MFR Series Remote Control Unit Features

Model	Button		Function Button		Page	Rotary Selector (CONTROL)	Features	
	No.	Color / Information Display	No.	Function			Hardware	Function
Standard Model								
MFR-16RU	16	1 Color ^{*3)}	2	Lock/ Page	2	-		
MFR-40RU	40	3 Colors ^{*2)}		-	32	-		
MFR-16RUD	16	1 Color ^{*3)}	2	Lock/ Page	2	-	LCD Display 16 letters x 2 lines	<ul style="list-style-type: none"> Display operation allows functions to be assigned to buttons. Display operation allows destination channel selection and crosspoint changes.
Simple Model								
MFR-16RUW	16	1 Color ^{*3)}	2	Free Assignable	32	-		
MFR-32RUW	32	1 Color ^{*3)}	2	Free Assignable	32	-		
MFR-64RUW	64	1 Color ^{*3)}	4	Free Assignable	32	-		
High-end Model with LCD Display								
MFR-18RU	18	3 Colors ^{*2)}	-	-	32	✓	LCD Display at the top of each button 7 colors / 7 letters x 2lines	<ul style="list-style-type: none"> SRC and DEST button assignments using CONTROL. With SKIP function. Associated source display above DEST buttons. Adjustable NAME display colors.
MFR-18RUA	18		-	-	32	✓	OLED Display at the top of each button	
MFR-8RUA	8		-	-	32	✓	7 colors / 7 letters x 2lines	
MFR-16RUTA	16		3	Lock x 1 Page x 2	32	✓	7 colors / 7 letters x 2lines	
MFR-39RU	39	OLED 7colors ^{*1)} 7 letters x 2 lines	1	Cancel	32	✓	LCD Display 23 letters x 2 lines	<ul style="list-style-type: none"> Multiple RU operation available. SETTING > BTN ASSIGN menu assigns functions to available buttons. SKIP function. Ten-key mode. Assignable remote control stored salvos. Adjustable Name display colors.
	10	3 Colors ^{*2)}						
MFR-39RUA	39	OLED 7colors ^{*1)} 7 letters x 2 lines	3	Current Source	32	✓	Current Page Display 7 colors / 7 letters x 2lines	<ul style="list-style-type: none"> Same functions as MFR-39RU. SRC and DEST button assignments using CONTROL.
	6	3 Colors ^{*2)}		Current Destination				

*1) 7 Colors = White/ Yellow/ Cyan/ Green/ Magenta/ Red/ Blue)

*2) 3 Colors = Red/ Green/ Orange

*3) 1 Color = Green

2. Setup

After connecting all devices, set up the remote control unit using Web-Based Control.

2-1. Connecting to Web-Based Control

1. Launch your web browser. Enter the URL, **http://192.168.1.12** (default) into your web browser. (When MFR-4000 is applied as a main unit, enter **http://192.168.0.12** (default))
2. Login screen is displayed. Input user name: **user** and password: **password** (default).

IMPORTANT

The MFR unit IP addresses, login user name and password described above are default settings. If any of the settings have been changed, use the new ones.

3. The main screen is displayed.

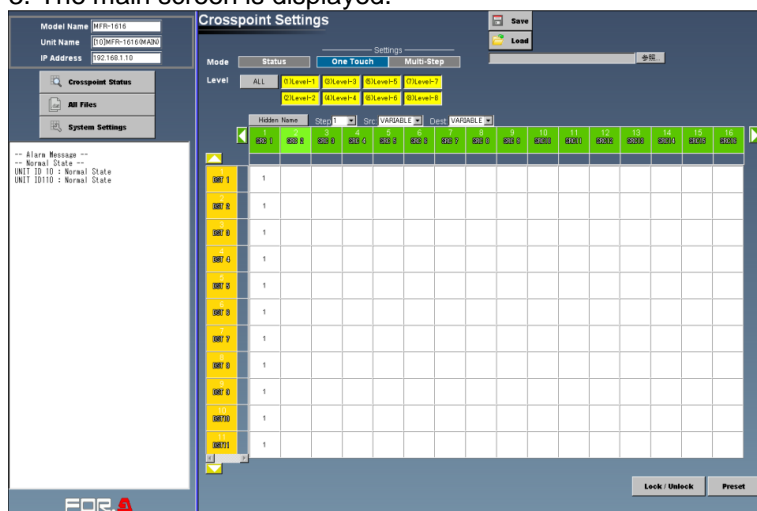

4. Click **System Settings**. Connected units are displayed as a tree diagram. Verify that the remote control model names are displayed.

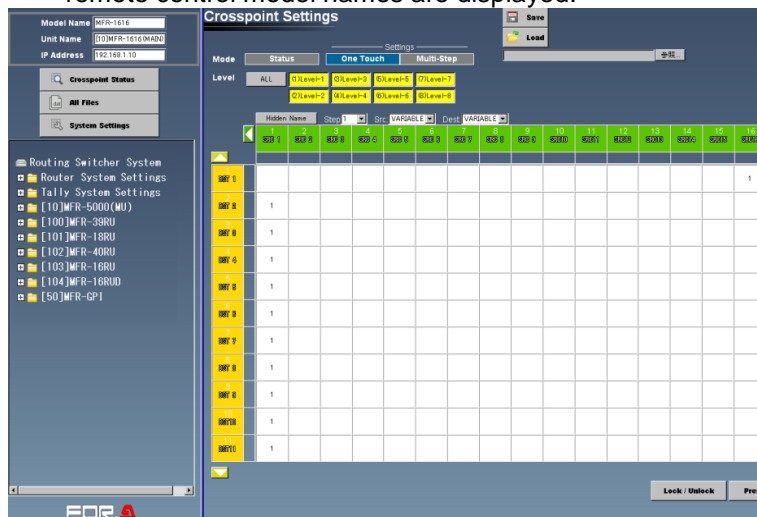

2-2. Assigning Functions to Buttons

This section describes the procedure how to assign Destination Function to the MFR-39RU button 1 as an example.

The screenshot shows the 'Assign Function' web interface for Unit ID 100. The interface is divided into several sections:

- Left Panel:** A navigation tree with 'System Settings' (1) selected. Under 'MFR-39RU', 'Assign Function' (2) is selected.
- Top Panel:** 'Assign Function' title, 'Unit ID 100', and buttons for 'Send' (7), 'Cancel', 'Save', and 'Load'.
- Button Grid (3):** A grid of buttons numbered 1 to 49. Button 1 is highlighted.
- Configuration Table (4):**

Page	Button ID	Assign	Function	LCD Color	ButtonColor	Group
1	1	All Pages	Destination (5)	Default	Default	A B C D
- Parameter Setting Pane (6):**

Logical No.	Name
1 (6)	DST.1 (6)

Level selection list (6):

 - 1:Level1
 - 2:Level2
 - 3:Level3
 - 4:Level4
 - 5:Level5
 - 6:Level6
 - 7:Level7
 - 8:Level8
- Callouts:** 'Remote Control Unit Image' points to the button grid.

1. Click **System Settings**.
2. Click **MFR-39RU** to open the tree. Click to select **Assign Function** to display the menu page.
3. Click the button 1 on the **Remote Control Unit Image**.
4. Select 1 under **Page**.
5. Select **Destination** under **Function**.
6. Set parameters in the **Parameter Setting** pane.
Logical No. (Channel no.), **Name** (Destination name) and **Level** (Level no.) are to be set here.
7. Click **Send**.

IMPORTANT

After clicking **Send**, do not turn off the remote control unit until the BUSY indicator, which lights orange, goes off since the system is writing to Flash. (About 2 minutes max.)

See Sec. 4 "Web-Based Control" for details.

3. Panel Descriptions

3-1. Front Panel

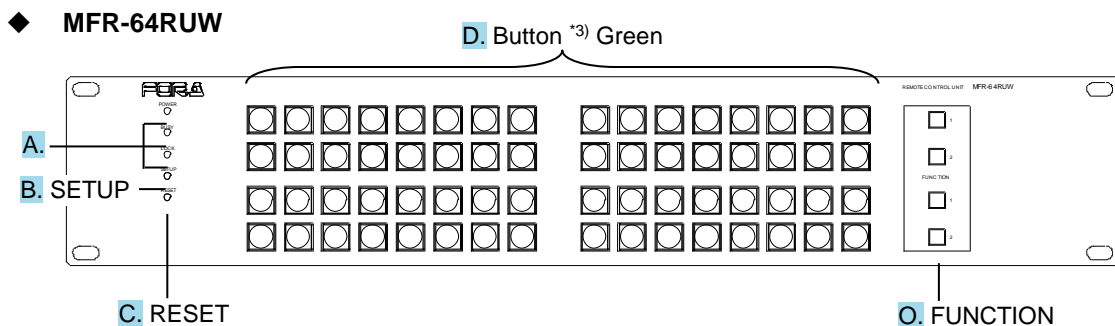
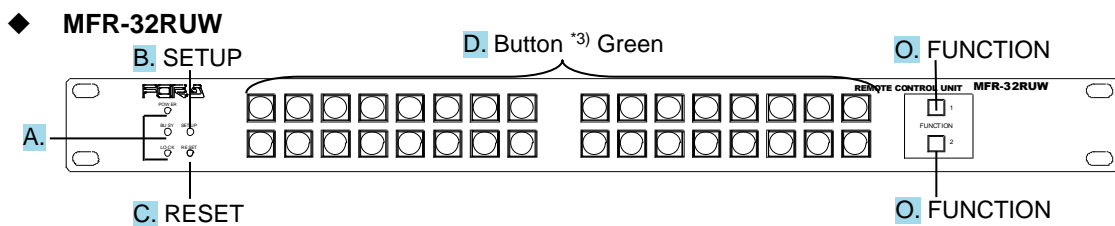
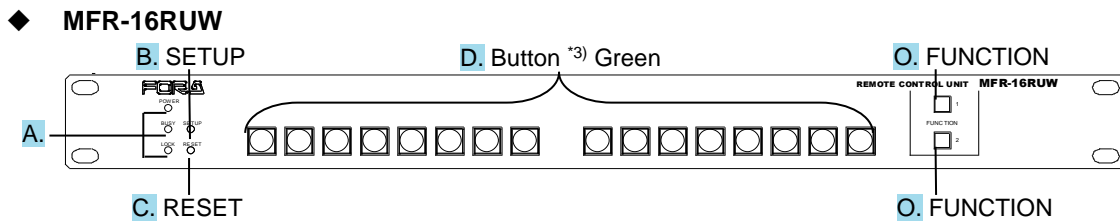
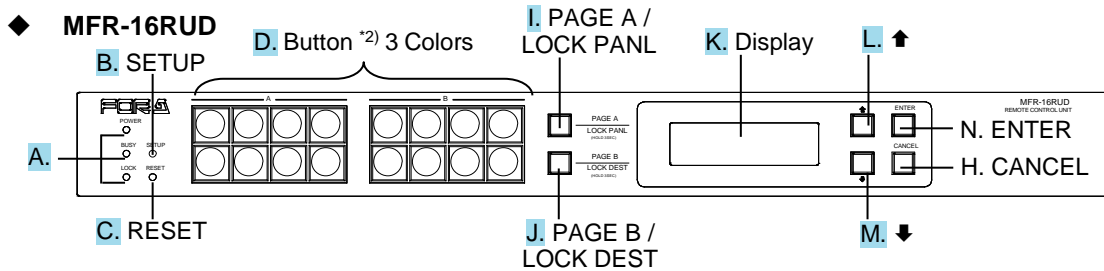
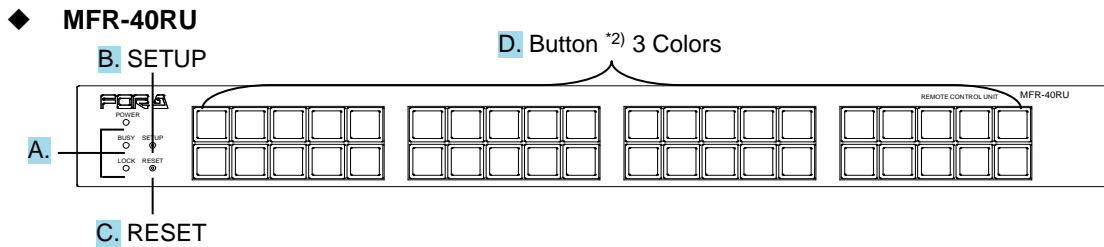
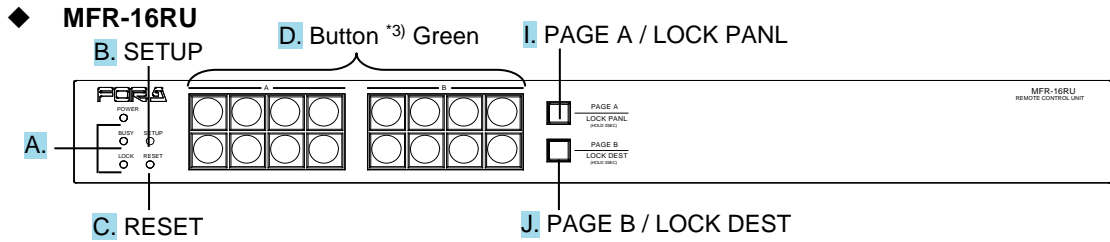

◆ **MFR-18RU/18RUA**

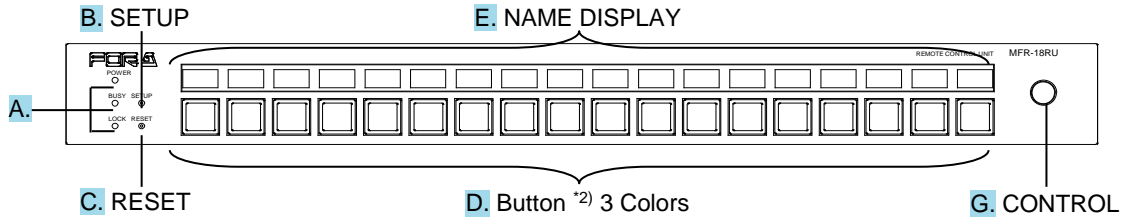

◆ **MFR-39RU**

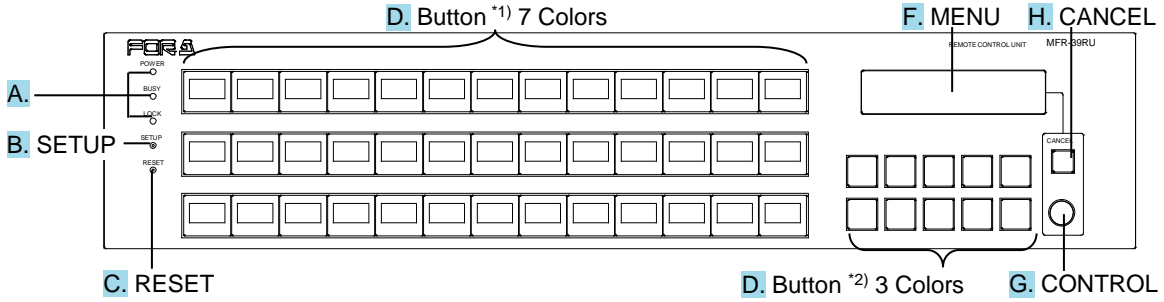

◆ **MFR-39RUA**

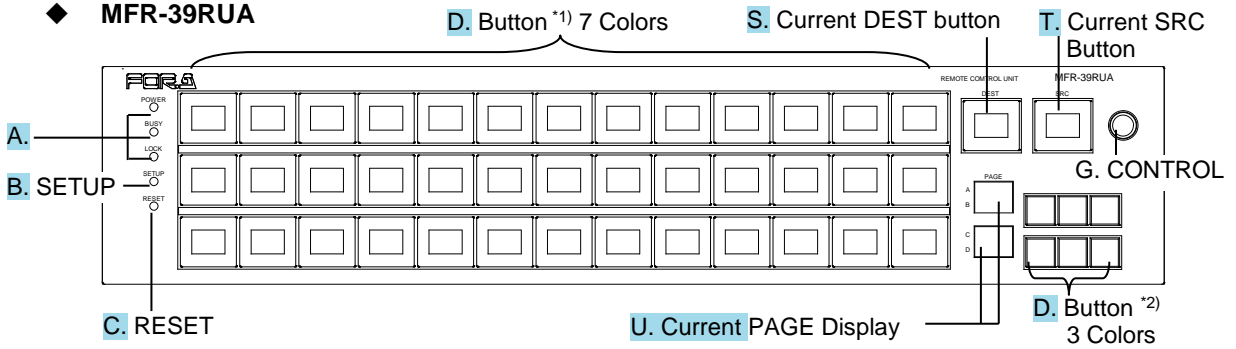

◆ **MFR-16RUTA**

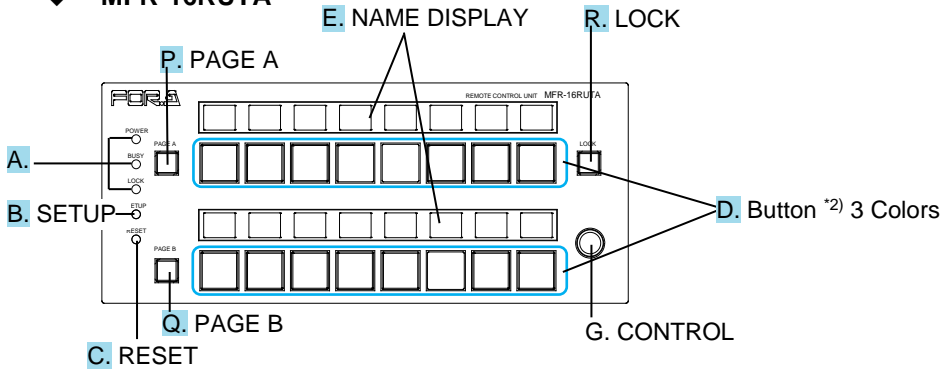

◆ **MFR-8RUA**

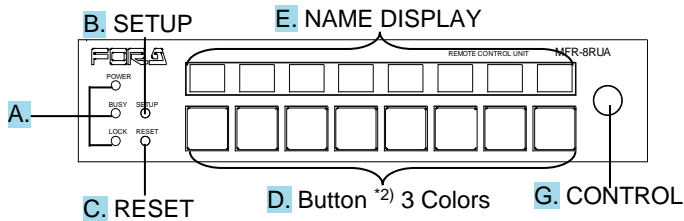

No.	Item	Description
A	POWER	Power status.
	BUSY	Displays the flash memory writing status of backup settings.
	LOCK	Lock status. ▶ See Sec. 6-3. "Lock" for details on the lock function.
	▶ See table on next page for details on LED color indications.	
B	SETUP	Displays Setup menu that allows you to set IP address and other settings. ▶ See Sec. 5-6, 5-7, 5-8, 5-9, 5-10, 5-11 "Setup Menu" for SETUP menu details.
C	RESET	Initializes the remote control unit.
D	Buttons	All buttons are user assignable. *1) 7-color selectable button name indication (red, green, yellow, blue, white, cyan or magenta) (hereafter called LCD) *2) 3-color selectable button illumination (red, green or orange) *3) Green illumination
E	NAME DISPLAY	7-color selectable button name/assignment indications (red, green, yellow, blue, white, cyan or magenta)
F	MENU	Displays setting menus and status.
G	CONTROL	Operates menu settings.
H	CANCEL	Cancels menu settings.
I	PAGE A / LOCK PANL	Switches pages. Pressing the button switches Page 1 and Page 2 of Group A. Button is unlit when Page 1 is current. Button is lit orange when Page 2 is current. To use the button as LOCK LOCAL, press and hold down (for 3 seconds). (*)
J	PAGE B / LOCK DEST	Switches pages. Pressing the button switches pages of Group B. Button is unlit when Page 1 is current. Button is lit orange when Page 2 is current. To use the button as LOCK ALL, press and hold down (for 3 seconds). (*)
K	Display	Displays crosspoints and button assignments.
L	↑	Up / Down buttons, select displayed items on Display operation.
M	↓	
N	ENTER	Confirms settings on Display operation.
O	FUNCTION	Function assignable buttons. (Light green)
P	PAGE A	When enabled, Group A pages can be changed using CONTROL .
Q	PAGE B	When enabled, Group B pages can be changed using CONTROL .
R	LOCK	Lock functions assignable button.
S	Current DEST button	Displays the current destination channel.
T	Current SRC button	Displays the current source channel.
U	Current PAGE display	Displays the current page.

(*) PAGE Switch and LOCK features are initially enabled and can be disabled in the [Web-Based Control: Assign Function page], respectively.

◆ **MFR-RU front panel color indications**

LED \ LED color	Green	Red	Orange
POWER LED	Normal	Power alarm	
BUSY LED	Normal processing		Writing to flash memory
LOCK LED	Operation locked by Lock Local	Operation locked by Lock All, or locked by Lock Other from another unit.	Activated Lock Other in unit.

- * LOCK LED flashes if the locked operation is accessed. The operation is normally disabled.
- * POWER LED lights red if the unit is turned on but not connected to a network.
- * All indicators, POWER, BUSY and LOCK, light orange while the SETUP menu is displayed.

IMPORTANT

After finishing settings, do not power OFF the unit while BUSY LED is lit orange, since the system is writing to Flash. (About 2 minutes max.)

◆ **Changing Button Labels**

Button labels can be changed on user-assignable buttons. Utilize button label templates in the FOR-A web site. To remove button caps, use the supplied tool.

To download button label templates, go to the **MFR-RU Series** page and open the **Documents** tab.

URL: http://www.for-a.com/products/mfr_ru_series/professional_router_p.html

3-2. Rear Panel

◆ **MFR-16RU / MFR-16RUD**

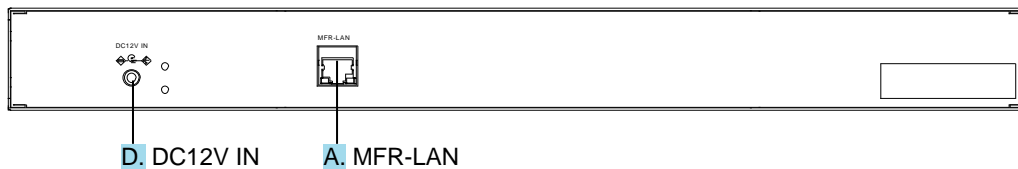

◆ **MFR-40RU / MFR-18RU / MFR-18RUA**

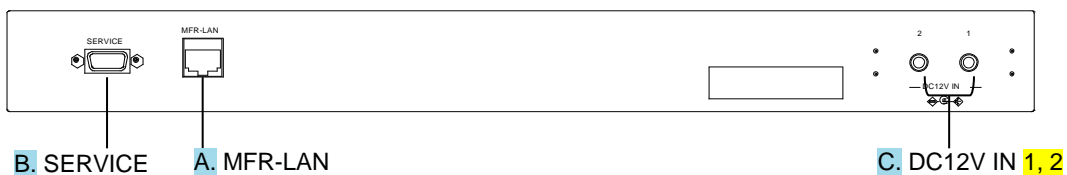

◆ **MFR-16RUW / MFR-32RUW / MFR-64RUW**

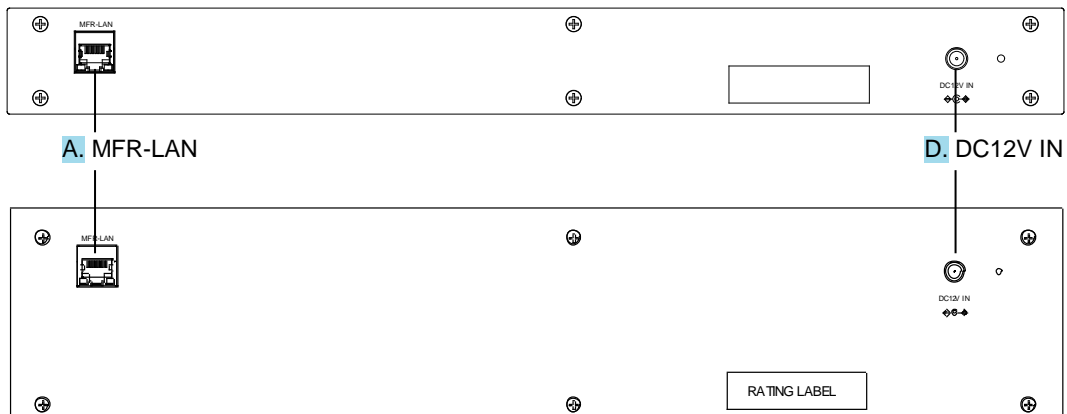

◆ **MFR-39RU / 39RUA**

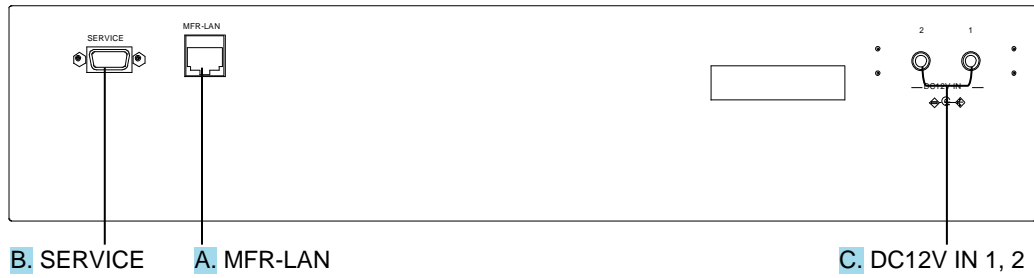

◆ **MFR-16RUTA**

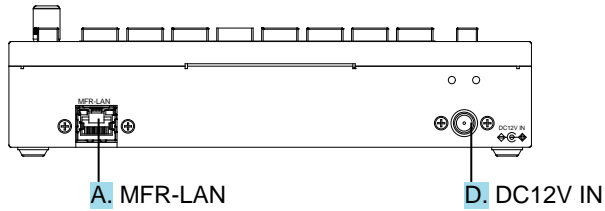

◆ **MFR-8RUA**

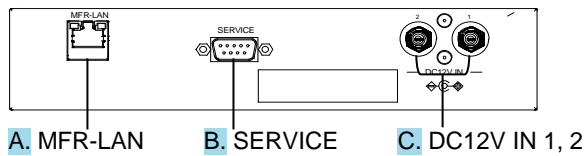

No.	Item	Description
A	MFR-LAN *1	Used to connect the MFR main unit Ethernet port (10/100BASE-TX)
B	SERVICE	Used for maintenance only. Do not use.
C	DC 12 V IN 1,2	Used to supply 12 V DC power.
D	DC 12 V IN	Used to supply 12 V DC power.

*1 The MFR-LAN port may be labeled 10/100BASE-T on the previous model.

4. Web-Based Control

When a remote control unit is clicked on the Web-Based Control screen, the tree opens. Menus in this section are displayed.

4-1. Assign Function



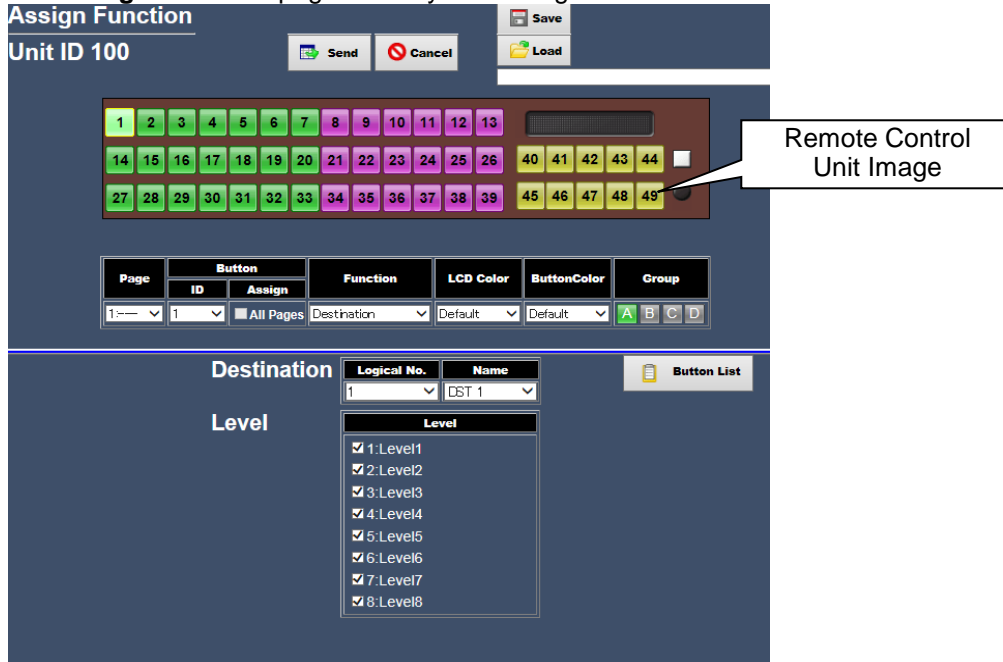

















The **Assign Function** page allows you to assign a function to each button.



















Parameter		Description
Page		Allows you to select a page for setting. The buttons actually placed on the remote control panel are considered as one page, and up to 32 pages can be set. Group A page names set in the RU Settings screen are also displayed.
Button	ID	Allows you to select the button ID to assign function. Button ID numbers are the same as those displayed on the Remote Control Unit Image.
	Assign	Checking on All Page assigns buttons in the same locations on each page to the same setting. * Note that All Pages settings are disabled, if button assignments are changed on a remote control unit. (The All Pages checkbox is changed to unchecked.)
Function		Allows you to select functions to assign. See next page, "Function List".
LCDColor		Allows you to select the LCD button and display color settings
ButtonColor		Allows you to select the button display colors.
Group		Allows you to create button Groups. Button Groups are separated by button color. Available Group numbers vary according to the RU type. - MFR-16RU/16RUD: Group A to B - MFR-16RUW/32RUW: Group A to C - MFR-40RU/18RU/39RU/16RUTA/18RUA/39RUA/16RUTA/8RUA: Group A to D - MFR-64RUW: Group A to E
Button List / Parameter		Clicking Button List displays the Remote Control Button Assignment image and allows you to verify which functions are assigned to which buttons.

◆ **Function List**

See Sec. 5-3. "Function Buttons" for details on button operations.

Function Setting	Parameter Setting	Remote Control Panel Button	Collective Setting																	
None	(No parameter)		Empty button	✓																
Destination	Logical No.: Channel number Name: Destination name Level: Level number		Destination button	---																
Source	Logical No. : Channel number Name: Source name Level: Level number		Source button	---																
Src(Bus Selector)	Destination / Source Logical No.: Channel number Level: Level number		BUS button	---																
Level	Level : Level number		LEVEL button	✓																
Take	(No parameter)		TAKE button	✓																
Lock	<p>Normal: Lock function by short press. Hold 3 sec: Lock function by long press If set to LOCK OTHER or LOCK ALL, a destination channel to be locked can be selected. 2-way button functions are as shown in the table below.</p> <table border="1" data-bbox="384 1037 786 1435"> <thead> <tr> <th>Normal</th> <th>Hold 3sec</th> </tr> </thead> <tbody> <tr> <td rowspan="2">LOCK OTHER</td> <td>NONE</td> </tr> <tr> <td>LOCAL</td> </tr> <tr> <td rowspan="2">LOCK ALL</td> <td>NONE</td> </tr> <tr> <td>LOCAL</td> </tr> <tr> <td rowspan="3">LOCK LOCAL</td> <td>NONE</td> </tr> <tr> <td>OTHER</td> </tr> <tr> <td>ALL</td> </tr> <tr> <td rowspan="3">NONE</td> <td>OTHER</td> </tr> <tr> <td>ALL</td> </tr> <tr> <td>LOCAL</td> </tr> </tbody> </table>	Normal	Hold 3sec	LOCK OTHER	NONE	LOCAL	LOCK ALL	NONE	LOCAL	LOCK LOCAL	NONE	OTHER	ALL	NONE	OTHER	ALL	LOCAL		LOCK button (2-way button: short or long press)	✓
		Normal	Hold 3sec																	
		LOCK OTHER	NONE																	
			LOCAL																	
		LOCK ALL	NONE																	
			LOCAL																	
		LOCK LOCAL	NONE																	
			OTHER																	
			ALL																	
		NONE	OTHER																	
ALL																				
LOCAL																				
	LOCK LOCAL button	✓																		
	LOCK button (Lock Other)	✓																		
																				
	LOCK button (Lock All)	✓																		
																				
																				
Page	<p>Up/Down: Allows you to select a mode from Jump, UP, or DOWN. Fwd: Allows you to set the page number to be viewed when the PAGE (Jump) button is pressed. Rev: Allows you to set the page number to be viewed when the PAGE (Jump) button is pressed again after a jump. Group: Allows you to set group(s) for navigating pages.</p> <p>* Page names are displayed when the names are set. (MFR-18RUA/ 39RUA/ 16RUTA/8RUA only)</p>		PAGE Jump button (Single group)	---																
			PAGE Jump button * (Single group) (18RUA/39RUA/16RUTA/8RUA)	---																
			PAGE Jump button (Multiple groups)	---																
			PAGE Jump button * (Multiple groups) (18RUA/39RUA/16RUTA/8RUA)	---																
			PAGE Jump button (All groups)	---																
			PAGE Jump button * (All groups) (18RUA/39RUA/16RUTA/8RUA)	---																
			PAGE UP button (Single group)	✓																
			PAGE DOWN button (All Groups)	✓																

Mode Select (*1)	Target: Allows you to select a mode from the following: Current Dest Src Level Page(All) Page(Group A) Page(Group B) Page(Group C) Page(Group D) Settings Mode selections are changed every time the MODE button is pressed.		MODE button (Destination mode)	✓
			MODE button (Source mode)	
			MODE button (Level mode)	
			MODE button (Page mode)	
			MODE button (Settings mode)	
Skip (*1)	Fwd/Back: Allows you to select a mode from Forward or Backward . Count: Allows you to set the number of mode to skip.		(Forward) SKIP button(SKIP FWD)	✓
			(Backward) SKIP button(SKIP BWD)	
Salvo	Store/Recall: Allows you to select a mode from Store or Recall . MU/RU (*5): Allows you to select the unit to recall an MU Salvo or RU Salvo . No.: Allows you to select the salvo number to recall. For details on MU Salvo recall, see Sec. 4-5. "Salvo".		(Store) SALVO button (Salvo Store) *2	✓
			(Recall, MU) SALVO button (MU Salvo recall)	---
			(Recall, RU) SALVO button (RU Salvo recall)	---
Link	(No parameter)		LINK button	✓
Ten-key (*2)	(No parameter)		TENKEY button	✓
Monitor (*3)	Out: Monitor output number		Monitor Out button	✓
Preview	Dest: Destination number		Operation Preview button	✓
Display Mode (*4)	(No parameter)		Display Mode button (with Destination name)	✓
			Display Mode button (with Source name)	✓

(*1) Available on MFR-18RU/39RU/18RUA/39RUA/16RUTA/8RUA.

(*2) Available on MFR-39RU/39RUA. If this function is assigned to another remote control unit, the button becomes non-functioning.

(*3) Available on MFR-5000/8000.

(*4) MFR-18RU/18RUA/16RUTA/8RUA only

(*5) Displayed as "MU/30FP" for MFR-30FP.

- ◆ **PAGE A / LOCK PANL** and **PAGE B / LOCK DEST** buttons on MFR-16RU-16RUD
Page Switch of Group A and **Lock Local** are assigned to **PAGE A / LOCK PANL** (17 on the GUI).
Page Switch of Group B and **Lock All** are assigned to **PAGE B / LOCK DEST** (18 on the GUI).
Each button function can be enabled/disabled on the GUI.

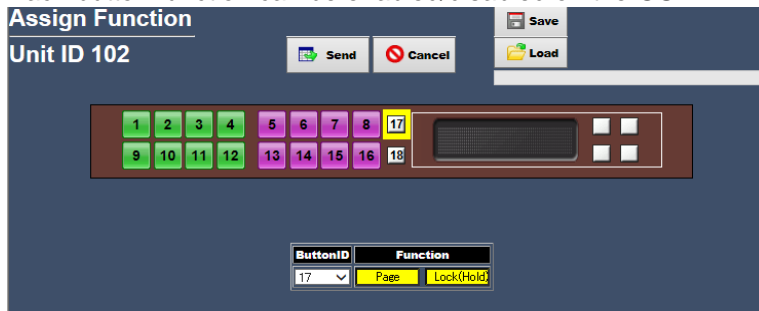

1. Click 17 or 18 to select a button.
2. Click Page or Lock(Hold) under Function to switch enabled/disabled.
Enabled: Yellow Disabled: Gray

Similarly, Page Switch is enabled/ disabled on MFR-16RUTA **PAGE A** button (17 on the GUI), and **PAGE B** button (18 button on the GUI).

- ◆ **LOCK** button on MFR-16RUTA
LOCK function is assigned to the **LOCK** button (19 on the GUI). LOCK type can be selected by GUI.

1. Click 19 to select a button.
2. Select the LOCK type in the parameter screen. (See “Function List” on page 18 for details on the LOCK type.)

4-2. RU Info

The **RU Info** page allows you to set remote control unit network settings and check power monitoring result.

Parameter	Description
Model Name	Displays the unit model name
Unit Name	Displays the unit name and unit ID.
Communication	Indicates the network status. (OK : Normal, NG : Error)
IP Address	Displays the IP address.
Subnet Mask	Displays the subnet mask.
MAC Address	Displays the MAC address.
Firmware Version	Displays the firmware versions.
FPGA Version	Displays the FPGA versions.
AC Power Input 1/2	Displays the AC adapter power input status. (OK : Normal, NG : Error, NONE : Not connected)
Voltage/12V/5V/3.3V/2.5V/1.8V/1.2V	Displays the power voltage level status. (OK : Normal, NG : Error)
Temperature	Displays the temperature.

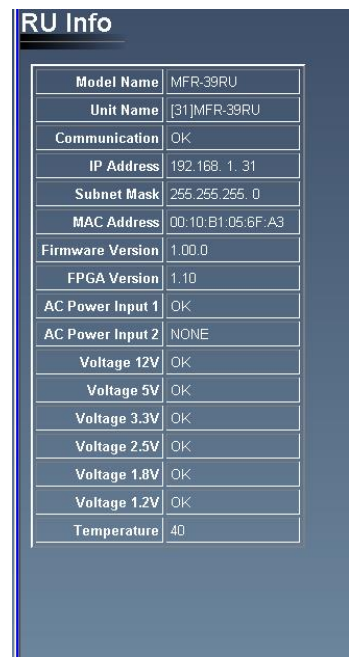

4-3. RU Settings

The **RU Settings** page allows you to set the remote control panel buttons and LCD settings. Available settings vary depending on the remote control unit type.

Parameter	Description	
IP Address (*1)	Sets the IP address.	
Unit Name	Changes the remote control unit name displayed in the navigation tree on the left side of the screen. Up to 10 alphanumeric characters available (excluding the following: & % () < >.). To change the name, check on the Enable checkbox, enter a new name, then click Send . Clicking System Settings on the left side of the screen updates the screen and applies the new name.	
MENU Brightness	Sets the MENU display panel brightness (1-8).	
Button Brightness	Sets the button LCD brightness (1-8).	
Button Brightness (Low Light)	Selects the button brightness between Normal and Reduce (dim-light).	
Function/ Source/ Destination/Lock/ Page Button Color/ Level Button/ Tally Color	LCD Color: Sets the LCD Color for each function respectively. Button Color: Sets the Button Color for each function respectively.	
Master ID (for RU Linkage)	Specifies the master unit ID for multi-panel operation.	
RU Linkage	Enables and disables multi-panel operation.	
Name Type	Dest	Sets the destination name display format.
	Src	Sets the source name display format.
	Level	Sets the level name display format.
Display Setting	Sets the displayed MFR-18RU/18RUA/16RUTA/8RUA LCD screen name. (Destination Name: Destination channel name Source Name: Source channel name)	
Src (Bus Selector) Button Display	Sets the LCD button display text when assigning a button Src (Bus Selector). Both (Src&Dst): Displays the Source and Destination names. Source Only: Displays only the Source name.	

Parameter	Description	
IP Address (*1)	Sets the IP address.	
Unit Name	Changes the remote control unit name displayed in the navigation tree on the left side of the screen. Up to 10 alphanumeric characters available (excluding the following: & % () < >.). To change the name, check on the Enable checkbox, enter a new name, then click Send . Clicking System Settings on the left side of the screen updates the screen and applies the new name.	
MENU Brightness	Sets the MENU display panel brightness (1-8).	
Button Brightness	Sets the button LCD brightness (1-8).	
Button Brightness (Low Light)	Selects the button brightness between Normal and Reduce (dim-light).	
Function/ Source/ Destination/Lock/ Page Button Color/ Level Button/ Tally Color	LCD Color: Sets the LCD Color for each function respectively. Button Color: Sets the Button Color for each function respectively.	
Master ID (for RU Linkage)	Specifies the master unit ID for multi-panel operation.	
RU Linkage	Enables and disables multi-panel operation.	
Name Type	Dest	Sets the destination name display format.
	Src	Sets the source name display format.
	Level	Sets the level name display format.
Display Setting	Sets the displayed MFR-18RU/18RUA/16RUTA/8RUA LCD screen name. (Destination Name: Destination channel name Source Name: Source channel name)	
Src (Bus Selector) Button Display	Sets the LCD button display text when assigning a button Src (Bus Selector). Both (Src&Dst): Displays the Source and Destination names. Source Only: Displays only the Source name.	

Page Display	Type	Selects the MFR-39RUA Current Page Display (C/D) type. Default: Current Group Pages C and D Unit Name: Unit name
	Unit Name Color	Selects the Unit Name color displayed in the Current Page Display (C/D)
Control (Dest/Src/Level/Page/Settings Selector)		Enables and disables CONTROL .
Control DestMode		* MFR-18RU/18RUA/39RUA/16RUTA/8RUA only Sets operation by pressing a Destination button while pressing down CONTROL on the remote control panel. (Disable: Disables the operation. Assign: Changes the selected Destination channel assignment. Crosspoint: Changes the selected Destination crosspoint assignment.)
Current SRC/DEST Button		* MFR-39RUA only Enables/Disables current SRC/DEST buttons.
Default (*1)	Mode	Sets the default Mode. Checking Apply to Current Mode applies the setting immediately after the Send button is clicked.
	Dest	Sets the default Destination Channel. Checking Apply to Current Dest applies the setting immediately after the Send button is clicked.
	Level	Sets the default Level. Checking Apply to Current Level applies the setting immediately after the Send button is clicked.
	Page	Sets the default page. (Last Page: Displays the last page that was displayed when the RU was shutdown. Select No.: A specified page is displayed as default. By checking Apply to Current Dest and clicking Send , immediately reflects the setting.
Take Mode		Sets TAKE Mode. (Preset: Clicking the TAKE button enables the TAKE function. Direct: The TAKE function is always enabled.)
Button hold time for Lock Release		Sets the unlock duration between 6 and 10 seconds.
Page	Max Number	Sets the maximum page number. If decreasing the number, a confirmation dialog appears. Click OK applies the change.
	Wrap Around	Sets the operation when switching pages from CONTROL or PAGE UP/DOWN button. (ON: After reaching page max., pages loop as, Page MAX→Page 1→Page 2... OFF: Disables loop switching.
	Mode	Sets CONTROL operation in Page mode. UpDown: Moves 1 page forward or backward. Jump: Turning and pressing CONTROL selects and jumps you to the selected page.
	Assign Mode	Sets PAGE button assignment mode. One Page: Assigns PAGE to the button in the selected page. All Pages: Assigns PAGE to the button in all pages.
	Page Name	Shows/hides the Page Name Setting field. Set Page Name: Shows the setting field. Close Page Name: Hides the setting field.

Ten-key	Enter Enable	Sets how the keys function in Ten-key mode. Enter: Applies the value when the Enter key is pressed. Direct: Applies the value directly when numeric keys are pressed.
	Starting Number	Sets the lowest numeric value (1 or 0) in the key range for Ten-key mode.

(*1) Changes are applied after the remote control unit is rebooted.

➤ Page Name Settings

Page Name	Allows names to be set for each page. Different names are settable per group. Page names are used in the Assign Function page.
LCD Color	*MFR-39RUA only Allows individual page color settings for the current MFR-39RUA page and LCD display of PAGE Jump buttons.
Button Color	Allows PAGE Jump button colors to be set for each page.

4-3-1. Saving and Loading the Settings File

Allows you to save and load GUI page settings as a file.

<Saving GUI page settings>

1. Click **Save**.
2. A confirmation dialog appears. Click **Save** in the dialog and select the file destination and name.
Checking the **Without IP address** check box does not save IP address settings to the file and is useful when you want to copy settings from one RU to another.

<Loading setting files>

1. Specify the file to be loaded under **Load**.
2. Click **Load** to load settings to the page.

4-4. Src/Dest-Inhibit

The **Src/Dest Inhibit** page allows specific source and destination selections to be inhibited via remote control panels.

The screenshot shows the 'Src/Dest-Inhibit' configuration interface. It features two main tables for configuring inhibition settings. The left table is titled 'Destination' and the right table is titled 'Source'. Both tables have columns for 'Logical No.', the specific destination/source name, and an 'Inhibit' checkbox. In the 'Source' table, the entry for 'SRC11' is selected and its 'Inhibit' checkbox is checked. The interface also includes 'Send', 'Cancel', 'Save', and 'Load' buttons at the top, and 'Inhibit Free' buttons at the bottom of each table.

Logical No.	Destination	Inhibit
1	DST 1	
2	DST 2	
3	DST 3	
4	DST 4	
5	DST 5	Inhibit
6	DST 6	
7	DST 7	
8	DST 8	
9	DST 9	
10	DST10	
11	DST11	
12	DST12	
13	DST13	
14	DST14	
15	DST15	
16	DST16	
17	DST17	
18	DST18	
19	DST19	
20	DST20	

Logical No.	Source	Inhibit
1	SRC 1	
2	SRC 2	
3	SRC 3	
4	SRC 4	
5	SRC 5	
6	SRC 6	
7	SRC 7	
8	SRC 8	
9	SRC 9	
10	SRC10	
11	SRC11	Inhibit
12	SRC12	
13	SRC13	
14	SRC14	
15	SRC15	
16	SRC16	
17	SRC17	
18	SRC18	
19	SRC19	
20	SRC20	

◆ **Enable/disable Inhibit**

1. Select a destination or source.
2. Click **Inhibit Free** to enable or disable inhibit.
Enabled: Black letters
Disabled: Grayed out letters
3. Click **Send**.

4-5. Salvo

The Salvo page allows you to register Salvos to a remote control unit.

◆ **Storing Front Panel Salvo Data**

1. Select enabled/disabled for each level
(Enabled: yellow, Disabled: gray)
2. Click **Setting** to start storing salvo.
3. Specify the salvo number. (Max 100)
4. Input the salvo name in **Name**.
5. Select crosspoints to save as a salvo. Up to 5,120 salvos with 256 max. crosspoints per salvo can be registered.
Clicking **Copy** loads current crosspoints. (If current destination channel is 257 and over, **Copy** does not function.)
6. Select the destination channels to save. The selected channels are highlighted yellow.
7. Click **Entry**. The salvo is stored.
Clicking **Cancel Select** cancels destination channels selection.

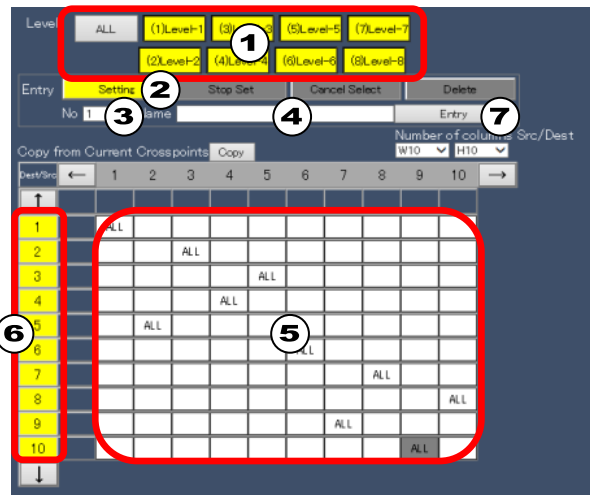

◆ **Deleting a crosspoint**

▼By selecting a destination channel

1. Click a destination channel to delete, which turns gray.
2. Click the **Entry** button. Only yellow-highlighted destination channels are registered.

▼By using the **Delete** button

1. Click the **Stop Set** button to stop salvo storing.
2. Click the **Delete** button.
3. The **Delete** button and crosspoints are highlighted yellow. Click a crosspoint from among those highlighted. Click the **Delete** button to exit Delete mode.
4. Click the **Setting** button.
5. Click required destination channels to highlight them yellow.
6. Click the **Entry** button.

5. Remote Control Unit Operation

5-1. Function and Operation

The below table shows the functions that can be controlled using a remote control unit (RU) and/or Web-Based Control (GUI).

* For details on Web-Based Control operation, see the separate MFR SERIES Web-Based Control Operation Manual.

◆ Description on Control Columns

✓: Changing settings and execution are both supported

●: Execution is supported

▲: Changing settings is supported

39: Supported by MFR-39RU, MFR-39RUA

18: Supported by MFR-18RU, MFR-18RUA

16D: Supported by MFR-16RUD

16T: Supported by the MFR-16RUTA

8: Supported by MFR-8RUA

Function		Controller	Remote Control Units	Web-based Control	Ref.
Crosspoint change (1 channel)	By changing source and/or destination		✓	✓	6-1-1
	Using bus buttons		✓	---	6-1-2
	Using buttons and CONTROL (Rotary Selector)		18, 16T 39RUA, 8	---	5-2-4
	Using the display		16D	---	5-5-1
	CHOP function		●	---	6-1-3
	TAKE function		●	✓	6-1-4
Crosspoint change (Simultaneous)	Main unit stored SALVO		●	▲	6-2-1
	RU button assigned SALVO		39, ●	▲	4-5, 6-2-2
	TAKE function		●	✓	6-2-3
	LINK function		●	▲	6-2-4
Error prevention	LOCK LOCAL		✓	---	6-3-1
	LOCK OTHER/ALL		✓	✓	6-3-2
	Crosspoint inhibition		---	✓	4-4
	Operation Preview function		●	---	6-5
Main unit and system setting change	Source/destination name settings		---	✓	Web
	Bitmap images display		18,39RUA, 16T, 8	Web (offline)	Web (offline)
	System tally settings		---	✓	Web
Remote control setting change	Mode menu		18, 39, 16T, 8	---	5-4-2
	Button assignment		18, 39, 16T, 8 ^(*) , 16D	✓	4-1, 5-4-3-2 (5-4-2)
	PAGE function		✓	---	4-1, 5-2-2
	Group setting		---	✓	4-1, 5-2-2-1
	Multi-panel operation		39 ^(**)	▲	4-3, 5-12-2
	IP address setting		▲	▲	4-3, 5-8-1
	Other settings		39	✓	4-3, 5-4-3 5-8
Status display		●	●	4-2, 5-4-4-2	
Alarm indication		●	●		

^(*) Source and destination button/channel assignments can be performed using **CONTROL** on MFR-18RU/18RUA/39RUA/16RUTA/8RUA units.

^(**) MFR-39RU/39RUA can change operational settings on multiple RU operation while other remote control units can only be used for operation.

5-2. Basic Operations

This section describes basic operation of remote control units and how to set and execute various functions.

5-2-1. Operating Buttons

1) Assigning functions to buttons (changing assignments)

First of all, assign RU front panel button functions referring Sec. 2-2. "Assigning Functions to Buttons". Any function can be assigned to any button except for **CANCEL**, **PAGE A**, **PAGE B**, **UP**, **DOWN**, **ENTER**, **CURRENT DEST**, **CURRENT SRC** or **LOCK** buttons.

As for MFR-16RUD, you can use the front panel display to assign functions to buttons.

▶ See Sec. 5-5-2. "Changing Button Assignments" for details

As for MFR-18RU/ 18RUA/ 39RU/ 39RUA/ 16RUTA/ 8RUA units, Source and Destination button/ channel assignments can be performed using **CONTROL**.

▶ See Sec. 5-2-4. "Operating with **CONTROL** (Rotary Selector)"

The MFR-39RU menu display can also assign functions.

▶ See Sec. 5-4-3-2 "BTN ASSIGN"

The MFR-39RUA menu display can also assign functions.

▶ See Sec. 5-4-4-4 "BUTTON ASSIGN"

2) Press buttons to execute functions

Press a button to execute assigned function. The button LED indication, NAME DISPLAY, and MENU display change according to the assigned function.

5-2-2. Switching Pages

Function assignment to RU front panel buttons are controlled per page. Page functions allow you to switch all button-assigned functions by switching pages. Pages can be changed either by using the **PAGE** button (see Sec. 5-3 "Function Buttons") or **CONTROL** in the Mode menu. (See Sec. 5-4 "MODE Button and Mode Menu.")

There are also Page function settings in the Mode and Setting menus. Also refer to the following sections for miscellaneous settings. (MFR-39RU only)

- **PAGE** button assignment: "PAGE ASSIGN" on the table "Setting Mode menu items" in Sec. 5-4-3 "Setting Mode Menu (MFR-39RU)."
You can select the PAGE button to be assigned in certain pages or in all pages. Having **PAGE** buttons assigned to all pages helps you to find the **PAGE** button easily.
- Mode menu settings: "PAGE MODE" on the table "Setting Mode menu items" in Sec. 5-4-3 "Setting Mode Menu (MFR-39RU)."
This section describes how to select pages using **CONTROL**.

5-2-2-1. Switching Pages per Group

Pages can be switched based on button groups. The number of available button groups differ depending on a remote control unit as shown in the table below. These groups can be freely changed using Web-Based Control.

Remote Control Unit	Button group
MFR-16RU/ 16RUD	A to B
MFR-16RUW/ 32RUW	A to C
MFR-64RUW	A to E
MFR-40RU/ 18RU/ 18RUA/ 39RU/ 39RUA/ 16RUTA/ 8RUA	A to D

Default button groups are set as shown in the figures below.

◆ MFR-16RU

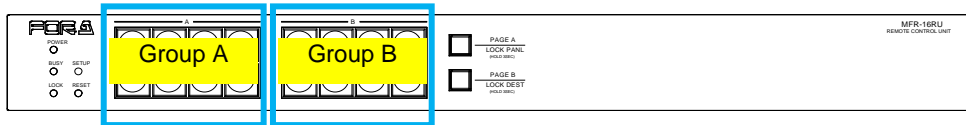

◆ MFR-40RU

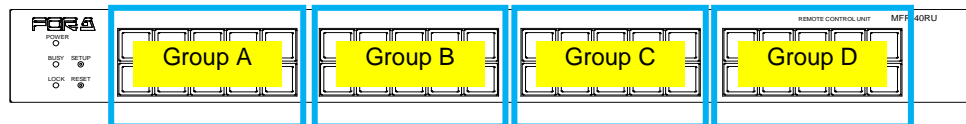

◆ MFR-16RUD

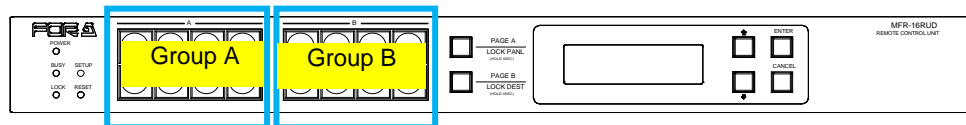

◆ MFR-16RUW

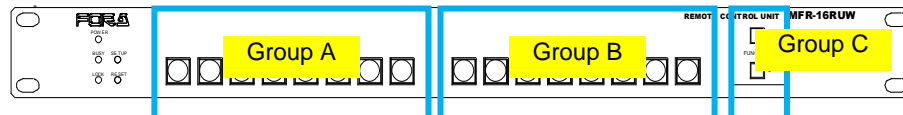

◆ MFR-32RUW

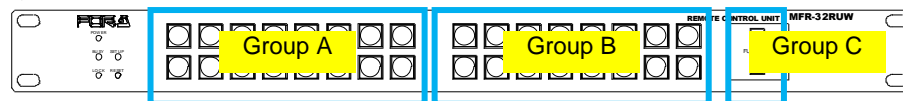

◆ MFR-64RUW

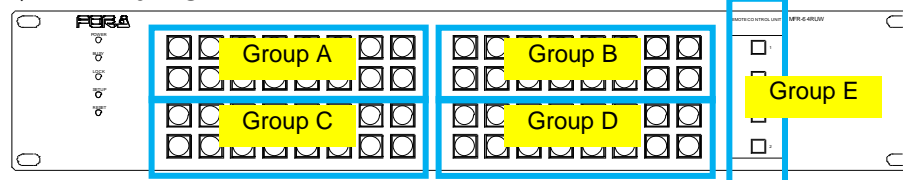

◆ MFR-18RU/18RUA

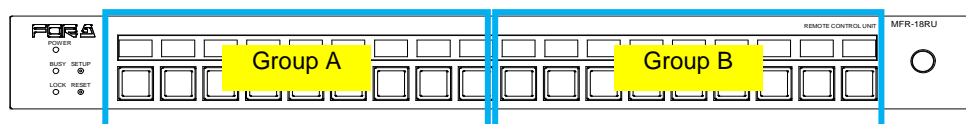

◆ **MFR-39RU**

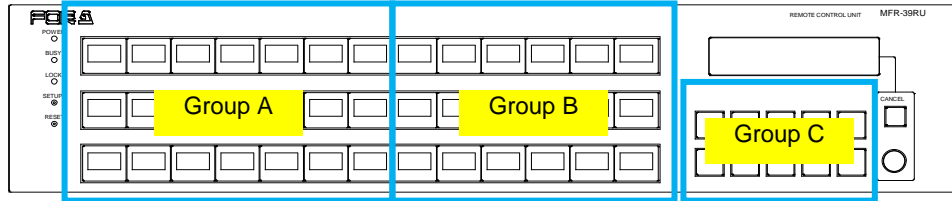

◆ **MFR-39RUA**

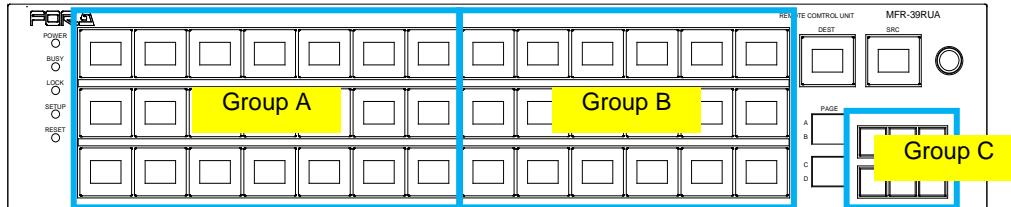

◆ **MFR-16RUTA**

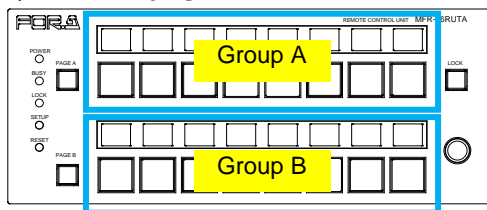

◆ **MFR-8RUA**

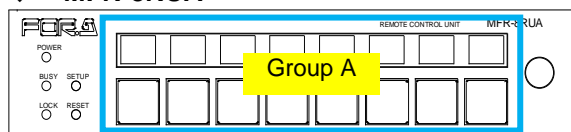

◆ **Page Limit and Maximum Page Number Setting**

- Maximum number of assignable pages (page limit):
 - 32 for MFR-40RU/ 16RUW/ 32RUW/ 64RUW/ 18RU/ 18RUA/ 39RU/ 39RUA/ 16RUTA/ 8RUA
 - 2 for MFR-16RU/ 16RUD
- Maximum page numbers are selectable for pages selected by Mode menu or Page buttons. (Excluding MFR-16RU/16RUD).
- Maximum page number settings are applied to all groups.
- Any page assignments or jumps are possible, but do not work if they exceed maximum page limits. (Buttons are masked with "x" in MFR-18RU/18RUA/39RU/39RUA/16RUTA/ 8RUA units.)
- Maximum page numbers can be set under **Page-Max number** in the [Web-Based Control: **RU Settings** page]. A warning dialog box will appear when the number is reduced and sent.
- If the currently displayed page number is over the maximum page number setting due to a change, the new maximum page is displayed as soon as the setting is changed.

5-2-3. Level Control

Generally, routing switchers control crosspoints according to the signal types such as video, audio, time codes, and VCR control. To control switchers, level numbers are used to identify the type of signal to control.

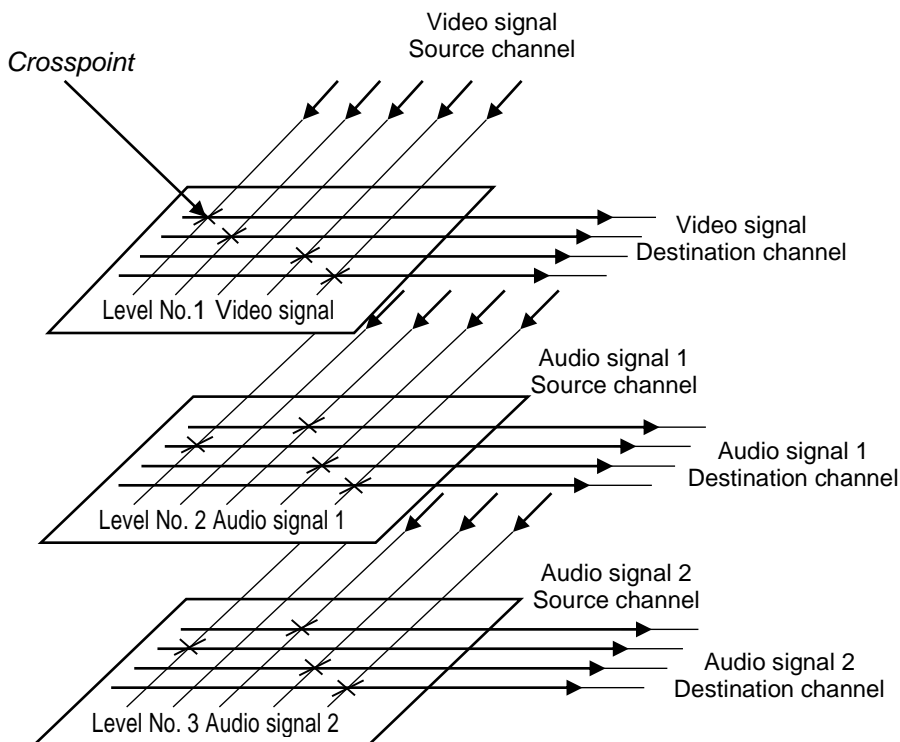

In the above example, if you select all the video signals to Level No. 1, you can switch video signal crosspoints when you select Level 1. In the same manner, if you select Level No. 2, you can switch audio signal 2 crosspoints. If you select multiple levels simultaneously, you can switch crosspoints on all of the selected levels at the same time.

◆ Assigning levels

Signals can be assigned to logical inputs and outputs using [Web-Based Control: **Assign Function** page]. When assigning the signals, select a level for respective signals to be assigned to the respective levels.

◆ Selecting levels on remote control units

The remote control unit can select channels on the current level. The current level can be changed using the **LEVEL** button or **CONTROL**. Multiple levels can be set to the current levels using the **LEVEL** button or **CONTROL**.

Pressing the **LEVEL** button allows you to go to the level that was selected when signals were assigned.

To change levels using **CONTROL**, press the **MODE** button and select a Level menu in the Mode menu.

▶ See Sec. 5-4 "MODE Button and Mode Menu."

5-2-3-1. Displaying Levels on the Remote Control Unit

The remote control unit displays current level(s) by hexadecimal numbers in the MENU or LCD display.

(Ex.1) If all levels 1 through 8 are enabled, the indication is "00FF".

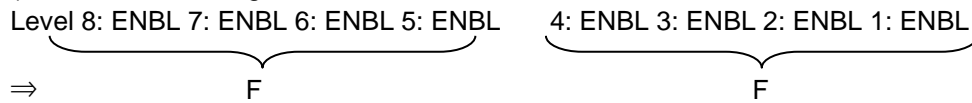

(Ex. 2) If levels 3, 4, 6, and 7 are enabled, the indication is "006C".

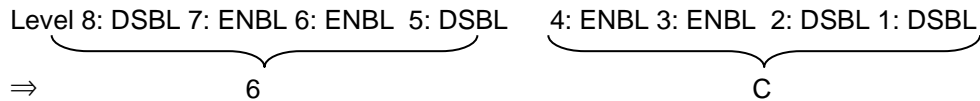

* ENBL: enabled
DSBL: disabled

If multiple levels are selected to their current levels, the smallest enabled level number is indicated in the MENU or LCD display.

In the above case (Ex.1): indicated as Level1

In the above case (Ex.2): indicated as Level3

5-2-4. Operating with CONTROL (Rotary Selector)

If your MFR Remote control unit has **CONTROL** (Rotary Selector), you can select destination channels or other items using **CONTROL**.

You can also select menu items by turning **CONTROL** to select an item and pressing **CONTROL** to confirm the selection.

CONTROL allows you to select displayed or settable items by switching the MODE menu. (See Sec. 5-4. "Mode Button and Mode Menu" for details.)

◆ MFR-18RU/18RUA

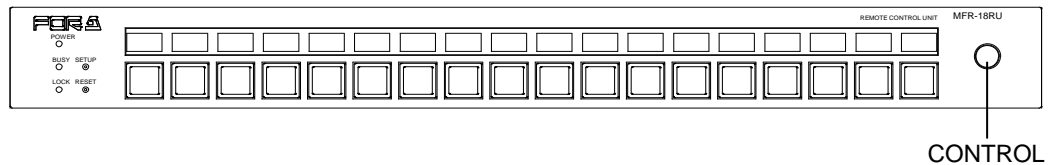

◆ MFR-39RU

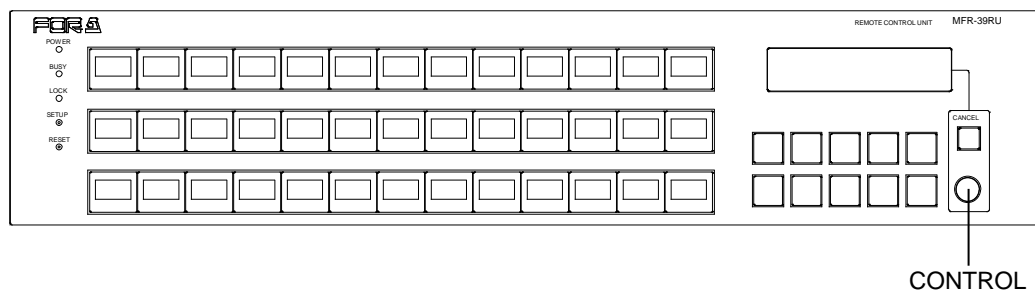

◆ **MFR-39RUA**

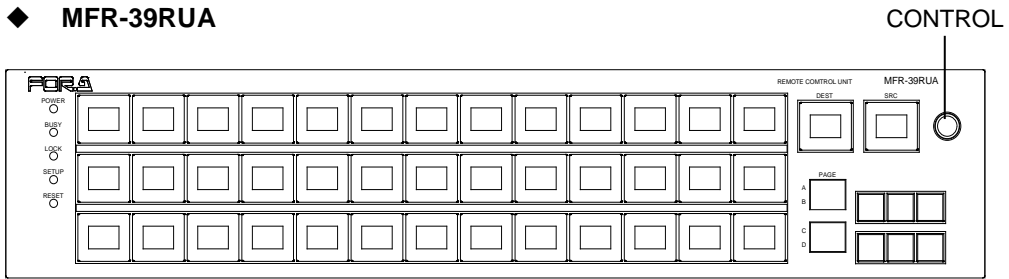

◆ **MFR-16RUTA**

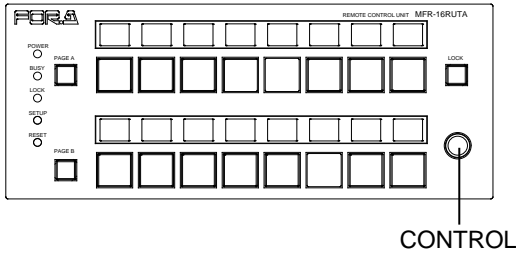

◆ **MFR-8RUA**

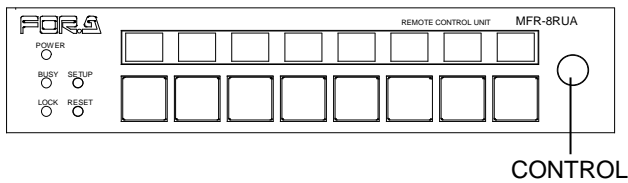

* **CONTROL** can be disabled or enabled in the [Web-Based Control: **RU Settings** page]

Selecting a source or non-function button on MFR-18RU/18RUA/39RUA/16RUTA/8RUA units allows you to change the source channel assignment.

These units perform one of the following three operations set in the **RU Settings** page by selecting a **Destination** button.

- **Assign** (default): Allows you to change the channel assignment of the selected **Destination** button.
- **Crosspoint**: Allows you to change the crosspoint assignment source channel of the selected Crosspoint button.
- **Disable**: The operation is disabled.

An operation procedure example (MFR-18RU) is as follows:

1. Press any source, destination or non-function button while holding down **CONTROL**. The button light sequentially changes its color from red to orange, then green.

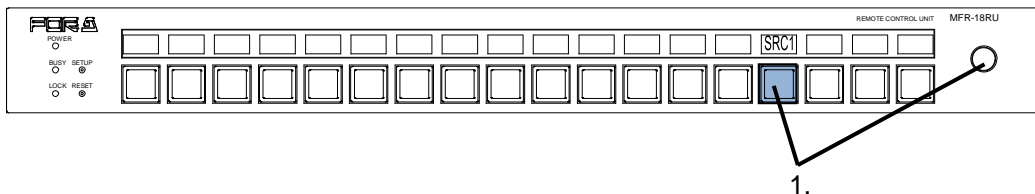

2. Turn **CONTROL** to select a source channel to assign to the button.

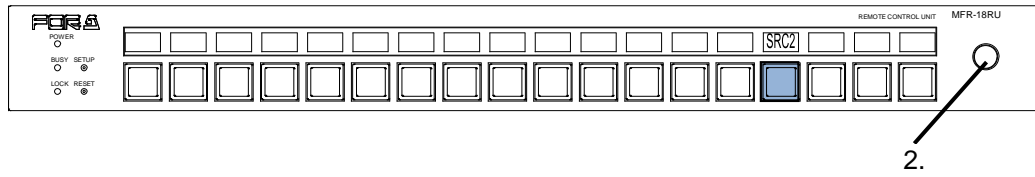



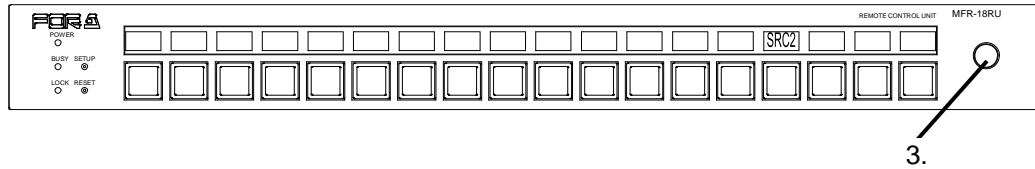



















3. Press **CONTROL** to confirm the change. To cancel the change, press the selected source button. After confirming or canceling the change, the button light returns to the previous state.















5-3. Function Buttons

Functions assignable to RU buttons are as shown in the table below. Assign functions using Web-Based Control ([Web-Based Control: **Assign Function** page]). MFR-39RU (See Sec. 5-4-3-2. "BTN ASSIGN") and MFR-16RUD (see Sec. 5-5-2. "Changing Button Assignment") are enabled to assign functions by RU themselves.

Function	Button indication	Description	Reference	
None		No function is assigned.		
Destination		Changes the current destination channel to the destination channel assigned to the button. Re-pressing the button displays the Unit ID that is locking a locked destination channel. If the destination channel is locked, the button lights up with a color indicating LOCK OTHER or LOCK ALL, which were set in the [Web-Based Control: RU Settings page].	6-1-1	
Source		Changes the current destination channel source to the source assigned to the button.	6-1-1	
Bus		Changes the destination channel source that is assigned to this button to the source channel assigned to this button.	6-1-2	
PAGE	<p>Changes pages to be displayed to a specified, next or previous page. When jumped to a specified page, a menu allows you to select whether to return to the previously displayed page or to display the next specified page after jumping. Target group(s) is/are displayed on the bottom of the button indication. See Sec. 5-2-2. "Switching Pages" and Appendix: "How to use Page buttons" for details on Page button setting and operation.</p>			
		PAGE JUMP (Single)	Switches the page to 1 for Group B.	5-2-2
		PAGE JUMP (Single) (*1)		
		PAGE JUMP (Multi)	Switches the page to 1 for Group A and C.	
		PAGE JUMP (Multi) (*1)		
		PAGE JUMP (All)	Switches the page to 1 for all groups.	
		PAGE JUMP (All) (*1)		
		PAGE UP (Single)	Moves the page forward by 1 for Group A.	
		PAGE DOWN (All)	Moves the page backward by 1 for all groups.	
<p>* A corresponding page name is displayed when assigning PAGE JUMP on MFR-18RUA/39RUA/ 16RUTA/8RUA units. (*1) MFR-18RUA/39RUA/ 16RUTA/8RUA units only.</p>				

Function	Button indication	Description	Reference																											
MODE	<p>* Supported for MFR-18RU/18RUA/39RU/39RUA/16RUTA/8RUA. Switches modes. Able to assign to one or multiple buttons. One button: Mode switches each time the button is pressed and the button indication changes accordingly. Multiple buttons: Select an assigning mode under BTN ASSIGN menu. * MFR-18RU/18RUA/39RU/39RUA/16RUTA/8RUA units only.</p>		5-4																											
		Destination mode																												
		Source mode																												
		Level mode																												
		Page mode ^(*) (PAGE_Grp-All / A / B / C / D) * The example at left shows the PAGE_Grp-All mode ^(*) The name set under Page Name Settings is displayed for PAGE Grp-A/B/C/D. (MFR-18RUA/39RUA/16RUTA/8RUA only)																												
	Setting mode																													
LOCK		<p>The following 4 Lock modes can be set by pressing a button for either a short or long time (more than 3 seconds). -LOCK OTHER: Disables control from external devices. -LOCK ALL: Disables all controls. -LOCK LOCAL: Disables local control. -NONE</p> <p>Assignable 2-way button functions (short and long press combinations) are as shown in the table below. Assign the functions to buttons in the Web-Based Control menu.</p> <table border="1"> <thead> <tr> <th>Short press function</th> <th>Long press function</th> <th>Button indication</th> </tr> </thead> <tbody> <tr> <td rowspan="2">LOCK OTHER</td> <td>NONE</td> <td>(C) or (C)' ^(*)</td> </tr> <tr> <td>LOCAL</td> <td>(A) ^(*)</td> </tr> <tr> <td rowspan="2">LOCK ALL</td> <td>NONE</td> <td>(D) or (D)' ^(*)</td> </tr> <tr> <td>LOCAL</td> <td>(A) ^(*)</td> </tr> <tr> <td rowspan="3">LOCK LOCAL</td> <td>NONE</td> <td>(B)</td> </tr> <tr> <td>OTHER</td> <td>(A) ^(*)</td> </tr> <tr> <td>ALL</td> <td>(A) ^(*)</td> </tr> <tr> <td rowspan="3">NONE</td> <td>OTHER</td> <td>(C) or (C)' ^(*)</td> </tr> <tr> <td>ALL</td> <td>(D) or (D)' ^(*)</td> </tr> <tr> <td>LOCAL</td> <td>(B)</td> </tr> </tbody> </table> <p>^(*) Button indications differ depending on the current or fixed destination. ^(*) The button indication changes if enabling either function, for example, if a combination of LOCK OTHER (short press) and LOCK LOCAL (long press) functions are assigned to a button, long pressing the button changes the indication to LOCK LOCAL.</p>	Short press function	Long press function	Button indication	LOCK OTHER	NONE	(C) or (C)' ^(*)	LOCAL	(A) ^(*)	LOCK ALL	NONE	(D) or (D)' ^(*)	LOCAL	(A) ^(*)	LOCK LOCAL	NONE	(B)	OTHER	(A) ^(*)	ALL	(A) ^(*)	NONE	OTHER	(C) or (C)' ^(*)	ALL	(D) or (D)' ^(*)	LOCAL	(B)	6-3-1 6-3-2
	Short press function		Long press function	Button indication																										
	LOCK OTHER		NONE	(C) or (C)' ^(*)																										
			LOCAL	(A) ^(*)																										
	LOCK ALL		NONE	(D) or (D)' ^(*)																										
			LOCAL	(A) ^(*)																										
	LOCK LOCAL		NONE	(B)																										
			OTHER	(A) ^(*)																										
			ALL	(A) ^(*)																										
	NONE		OTHER	(C) or (C)' ^(*)																										
ALL		(D) or (D)' ^(*)																												
LOCAL		(B)																												
																														
																														
																														
																														
																														

Function	Button indication	Description	Reference
TAKE		Enables TAKE function for simultaneous crosspoint changes.	6-1-4
LEVEL		Changes a level to the level specifically assigned to the button.	5-2-3
LINK		Enables or disables the LINK function.	6-2-4
TENKEY		Enables Ten-key keypad mode on the remote control unit for destination and source assignment by their channel numbers. * Supported only for MFR-39RU and MFR-39RUA.	6-1-1-2
SKIP	Skips a set number forward or backward to select one destination or source channel. * CONTROL needs to be pressed for Source selections.		
		Channel number increases in predetermined number.	6-1-1-1
		Channel number decreases in predetermined number.	
* Supported for MFR-18RU/18RUA/39RU/39RUA/ 16RUTA/8RUA.			
Monitor Out		Enables or disables the Monitor Out function. * Supported only for MFR-5000/8000.	6-4
Operation Preview		Enables or disables the Operation Preview function.	6-5
SALVO	Assigns and executes salvos assigned to buttons or those stored to main or remote control units.		
		Salvo Store	Assigns salvos to buttons.
		Salvo Recall (MU)	Executes a main unit-stored salvo
	Salvo Recall (RU)	Executes a remote control unit button-assigned salvo	
Display Mode	* MFR-18RU/18RUA/16RUTA/8RUA only Changes button indication between Destination and Source channel names.		
		Destination Channel Name	
		Source Channel Name	

◆ **Destination Button LCD Indication**

Destination channel names are ordinarily displayed on the LCDs above destination buttons. MFR-18RU, 18RUA, 16RUTA and 8RUA can also display source channel names that are selected for destinations. To display source channel names, set the menu under **Display Setting** in the [Web-Based Control: **RU Settings** page]. LCD indications can also be switched using the **Display Mode** button.

In the case of multi-level breakaway switching, the name of the level with the smallest number is displayed.

- MFR-18RU/18RUA

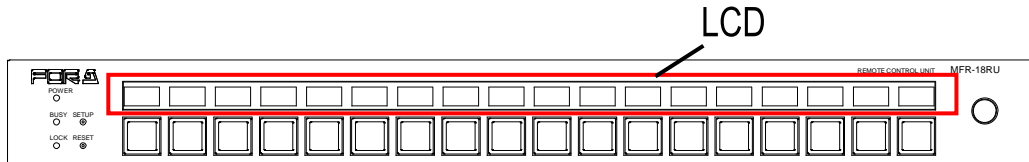

- MFR-16RUTA

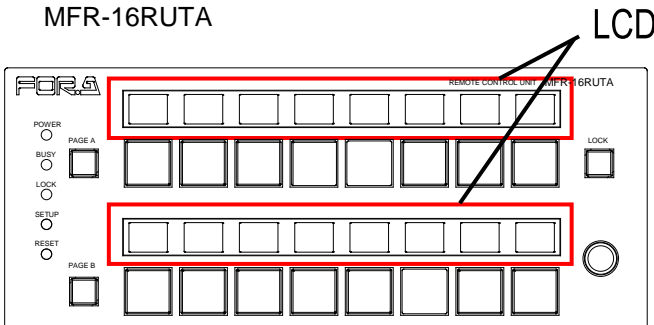

- MFR-8RUA

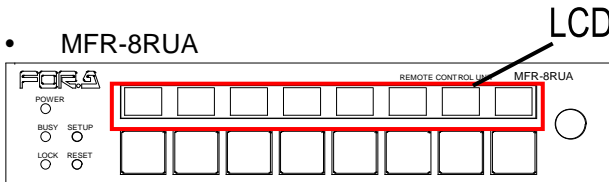

5-4. MODE Button and Mode Menu (MFR-18RU/18RUA/39RU/39RUA/16RUTA/8RUA)

5-4-1. Outline

The **MODE** button allows you to switch Mode Menu. By switching Mode Menu settings, displayed MENU and LCD items, and items using **CONTROL** (rotary selector) are switched. (Supported only for MFR-18RU/18RUA/39RU/39RUA/16RUTA/8RUA.)

Each Mode menu can be enabled or disabled. Only enabled Mode menu items can be switched and displayed by pressing the **MODE** button. Set unused mode menu items to disabled to allow for easier mode searches.

Multiple buttons can be assigned to **MODE** buttons. If multiple **MODE** buttons are assigned, a **MODE** button is highlighted and the corresponding LCD background illuminates when it is pressed.

5-4-2. Mode Menu

The Mode menu has 5 mode options. In setting mode, setting options are different for MFR-18RU/18RUA/39RUA/16RUTA/8RUA and MFR-39RU. (The menu display is supported only by MFR-39RU.)

◆ Destination Mode

MENU: Displays current destination channel [name] and level [name] settings.

LCD: Displays the current destination channel.

Current DEST button: Displays the current destination channel. Pressing the button shifts the status display between LEVEL and LOCK.

Turning **CONTROL**: Changes current destination channel.

DST: 1 [DST1]
LVL : 0001 [Level-1]

Menu display



Button LCD / Current DEST button (39RUA only)

◆ Source Mode

MENU: Displays the source channel [name] for a current destination.

LCD: Displays source channels for current destinations.

Current SRC button: Displays the source channel of a current destination channel.

Turning **CONTROL**: Changes source channel.

Pressing **CONTROL** applies the change.

* Press TAKE instead of **CONTROL** when applying source changes in TAKE mode.

SRC: 1 [SRC1]

Menu display



Button LCD / Current SRC button (39RUA only)

◆ Level Mode

MENU: Displays the current level [name] of the remote control unit.

LCD: Displays the current level and its name on the remote control unit.

Turning **CONTROL**: Changes RU current level.

LVL : 0001 [Level-1]

Menu display

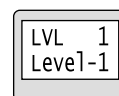

Button LCD

◆ Page Mode

MENU: Displays the page number currently assigned to the remote control unit.

LCD: Displays the page number currently assigned to the remote control unit.

Turning **CONTROL**: Changes the page number.

PAGE (UP/DOWN) : 1

Menu display



Button LCD

➤ MODE PAGE (PAGE_Grp-ALL)

PAGE JUMP	All group pages jump to the specified page.								
PAGE UP/DOWN	All group pages move forward or backward respectively.								
MENU display	<div style="border: 1px solid black; padding: 5px; margin-bottom: 5px;">PAGE (UP/DOWN) A: 1 B: 1 C: 1 D: 1</div> <div style="border: 1px solid black; padding: 5px;">PAGE (JUMP) A: 1 B: 1 C: 1 D: 1</div>								
LCD display	<div style="border: 1px solid black; padding: 5px; width: fit-content; margin: 0 auto;">Page Grp-All</div>								
Current PAGE display	<p style="text-align: center;">PAGE</p> <table style="margin-left: auto; margin-right: auto;"> <tr><td style="padding-right: 5px;">A</td><td style="border: 1px solid black; padding: 2px 10px;">01</td></tr> <tr><td style="padding-right: 5px;">B</td><td style="border: 1px solid black; padding: 2px 10px;">01</td></tr> </table> <table style="margin-left: auto; margin-right: auto;"> <tr><td style="padding-right: 5px;">C</td><td style="border: 1px solid black; padding: 2px 10px;">01</td></tr> <tr><td style="padding-right: 5px;">D</td><td style="border: 1px solid black; padding: 2px 10px;">01</td></tr> </table>	A	01	B	01	C	01	D	01
A	01								
B	01								
C	01								
D	01								

➤ MODE PAGE (PAGE_Grp-A/B/C/D)

PAGE JUMP	Specified group pages jump to specified pages.								
PAGE UP/DOWN	Specified group pages move forward or backward.								
MENU display	<div style="border: 1px solid black; padding: 5px; margin-bottom: 5px;">PAGE (UP/DOWN) Grp-C: 1</div> <div style="border: 1px solid black; padding: 5px;">PAGE (JUMP) Grp-C: 1</div>								
LCD display	<div style="border: 1px solid black; padding: 5px; width: fit-content; margin: 0 auto;">Page 1 Grp-C</div>								
Current PAGE display	<p style="text-align: center;">PAGE</p> <table style="margin-left: auto; margin-right: auto;"> <tr><td style="padding-right: 5px;">A</td><td style="background-color: black; color: white; border: 1px solid black; padding: 2px 10px;">01</td></tr> <tr><td style="padding-right: 5px;">B</td><td style="background-color: black; color: white; border: 1px solid black; padding: 2px 10px;">01</td></tr> </table> <table style="margin-left: auto; margin-right: auto;"> <tr><td style="padding-right: 5px;">C</td><td style="border: 1px solid black; padding: 2px 10px;">01</td></tr> <tr><td style="padding-right: 5px;">D</td><td style="background-color: black; color: white; border: 1px solid black; padding: 2px 10px;">01</td></tr> </table>	A	01	B	01	C	01	D	01
A	01								
B	01								
C	01								
D	01								

◆ **Setting Mode**

➤ In MFR-39RU

Displays settable menu titles.

Turn **CONTROL** to select a menu and change settings.

Changeable items are highlighted.

▶ See Sec. 5-4-3. "Setting Mode Menu (MFR-39RU)"

SETTING>DEF MODE <ENT>

Menu display

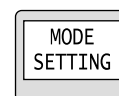



Button LCD

5-4-3. Setting Mode Menu (MFR-39RU)

Setting Mode menu items are as shown below. Follow the procedure below to change settings.

- (1) Turn and press CONTROL to select and enter each menu.
- (2) Turn and press CONTROL to select and confirm a menu setting.

◆ Setting Mode menu items

MENU	Setting	Description
DEF MODE *	DESTINATION SOURCE LEVEL PAGE_Grp-All PAGE_Grp-A to PAGE_Grp-D SETTING	Selects a mode to be displayed on the menu display at remote control unit start-up.
DEF DEST *		Selects a destination to be displayed at remote control unit start-up.
DEF LEVEL*		Selects a level to be displayed at remote control unit start-up.
DEF PAGE *	LAST SELECT	Selects a page to be displayed at remote control unit start-up. LAST: Displays the page that was displayed immediately before shutdown. SELECT: Displays the page that was set by DEF PAGE A-D.
DEF PAGE A-D *		Selects a Group A-D page to be displayed at remote control unit start-up.
PAGE MODE	UP/DOWN JUMP	Selects CONTROL behavior in Page mode. UP/DOWN: Every turn of CONTROL changes the page one page forward or backward. JUMP: Turn and press CONTROL to select and display the page.
PAGE ASSIGN	ONE PAGE ALL PAGE	Selects a PAGE button assignment. ONE PAGE: Assigns the PAGE button to one page. ALL PAGE: Assigns the PAGE button to all pages.
WRAPAROUND	ON OFF	Turns wraparound ON or OFF when changing a page using CONTROL or PAGE UP/DOWN button. ON: The page after Page MAX continues as Page 1 then Page2, in a continuous circular series. OFF: Wraparound is turned off.
DSTINHIBIT	ON OFF	Sets the inhibit function to a desired destination. ON: If set, the destination channel cannot be selected. The channel button is marked with an X.  OFF: If set, DST Inhibit is released and the destination channel can be selected.
SRCINHIBIT	ON OFF	Sets the inhibit function to a desired source. ON: If set, the source channel cannot be selected. The channel button is marked with an X.  OFF: If set, SRC Inhibit is released.

MENU	Setting	Description
NAME TYPE		Selects a display type for the destination, source and level name. (See Sec. 5-4-3-1.)
TENKEY MOD	ENTER DIRECT	Selects how to confirm changes in Ten-key mode. ENTER: Enter a value and press the ENTER button on the displayed Ten-key keypad to confirm. DIRECT: A value is confirmed when a value is entered using the Ten-key keypad.
TENKEY NO	0 1	Selects 0 or 1 for the Ten-key start point.
SALVO CLR		Clears a button-assigned Salvo.
BTN ASSIGN		Assigns functions to user-assignable buttons. (See Sec. 5-4-3-2.)
EXIT		Exits the Setting Mode menu.

* Do not turn off the remote control unit until the **BUSY** indicator changes from orange to unlit. Otherwise, settings may not be applied.

5-4-3-1. NAME TYPE

This menu selects a name display type for destination, source and level buttons.

```
SETTING>NAME TYPE
DST BTN :PHY NUM <ENT>
```

Turn and press **CONTROL** to select and confirm a button group from destination, source and level buttons.

```
SETTING>NAME TYPE
DST BTN :PHY NUM <ENT>
```

Turn **CONTROL** to select a display type, then press the knob to confirm the selection.

Display type	Description	Example indication		
		DST	SRC	LEVEL
PHY NUM	Physical number display	OUT1	IN1	LV0001
ASCII	Ascii character display (Alphanumeric characters and symbols)	MV_IN1	VTR1	Level-1
KANJI	2-byte character code including 1-byte character code (Unselectable for LEVEL)	出力1	素材1	

* When using 2-byte characters:

Up to 8 characters (including one-byte characters) on MFR-18RUA/39RUA/16RUTA/8RUA units

Up to 4 characters (including one-byte characters) on MFR-18RU/39RU units.

* Up to 14 characters when using only one-byte characters.

5-4-3-2. BTN ASSIGN

This menu assigns button functions to assignable buttons.

► See Sec. 5-3 “Function Buttons” for the assignable functions.

1. Select to change a button (BTN NO.) assignment by turning and pressing **CONTROL**, or by pressing the desired button.

```
SETTING>BTN ASSIGN
BTN NO: 1<ENT>
```

2. Select to change a button (PAGE) assignment by turning and pressing **CONTROL**.

```
SETTING>BTN ASSIGN
PAGE: 1<ENT>
```

3. Turn and press **CONTROL** to select and confirm the function. Set parameters for the function if necessary.

```
SETTING>BTN ASSIGN
FUNC:DEST <ENT>
```

The menu display asks you to confirm the assignment change as shown above when necessary settings are complete. To apply the change to the system, turn and press **CONTROL** to select **Yes**. Selecting **No** cancels the change and returns to the menu display to select buttons.

```
SETTING>BTN ASSIGN
EXEC:NO <ENT>
```

◆ Setting Function Parameters

Function	Parameter	Note
(NONE)		
DEST	DEST: XXX (XXX: Destination channel number)	
	LEVEL: XXXX (XXXX: Level)	
SRC	SRC: XXXX (XXXX: Source channel number)	
	LEVEL: XXXX (XXXX: Level)	
BUS	DEST: XXX (XXX: Destination channel number)	
	SRC: XXXX (XXXX: Source channel number)	
	LEVEL: XXXX (XXXX: Level)	
PAGE	MODE: JUMP (JUMP: Jump to a specified page /UP: Go forward one page /DOWN: Go backward one page)	
	PAGE: XX (XX: Page number)	* Effective for JUMP
	RETPAGE: XX (PREV PAGE: Return to the previous page /XX: Jump to the next specified page)	* Effective for JUMP
	GROUP-A: ON (ON / OFF)	
	GROUP-B: ON (ON / OFF)	
	GROUP-C: ON (ON / OFF)	
	GROUP-D: ON (ON / OFF)	
MODE	DESTINATION: ON (ON / OFF)	
	SOURCE: ON (ON / OFF)	
	LEVEL: ON (ON / OFF)	

Function	Parameter	Note
	PAGE_Grp-All: ON (ON / OFF)	
	PAGE_Grp-A: ON (ON / OFF)	
	PAGE_Grp-B: ON (ON / OFF)	
	PAGE_Grp-C: ON (ON / OFF)	
	PAGE_Grp-D: ON (ON / OFF)	
	SETTING: ON (ON / OFF)	
LOCK	LOCK[S]: OTHER (NONE / OTHER / ALL / LOCAL) Short press to LOCK function.	
	DEST: XX (CURRENT: Locks the current destination. / XX: Destination Channel number to be locked)	* Effective for OTHER and ALL
	LOCK[L]: NONE (NONE / OTHER / ALL / LOCAL) LOCK function by long press	
	DEST: XX (CURRENT: Locks the current destination. /XX: Destination Channel number to be locked)	* Effective for OTHER and ALL
TAKE		
LEVEL	LEVEL:XXXX (XXXX: Level)	
LINK		
TENKEY		
SKIP	MODE: FWD (FWD: Forward / BWD: Backward)	
	COUNT: XXX (XXX: Number of channels to skip)	
MON-OUT	OUT: X (X:MONITOR OUT)	* MFR-5000/8000 only
O-PREVIEW	DEST: XXX (XXX: Destination channel number)	
SALVO	MODE: (MU RECALL: Executes the main unit-assigned SALVO MU RECALL /RU RECALL: Executes the button-assigned SALVO /RU STORE: Assigns a SALVO to a button)	
	NO: XXXX (XXXX: Salvo number)	* Effective for MU RECALL, and RU RECALL

5-4-4. Setting Mode Menu (MFR-39RUA)

The current **SRC** button functions as an **EXIT/CANCEL** button used for exiting mode during **Setting** mode.

Use the following procedures to change settings.

- Press a button to turn On/Off.
- Use **CONTROL** to change values.
 1. Press to select a desired menu item.
 2. Turn **CONTROL** to change its value.
 3. Press **CONTROL** to confirm the setting.

After menu settings, do not turn off the remote control unit until the BUSY indicator changes from orange to unlit. Otherwise, settings may not be applied.

- * When **Setting** mode is entered by pressing the **SETUP** button, the **BUSY** indicator lights orange in **Setting** mode. Press the **EXIT/CANCEL** button to exit **Setting** mode. Before powering off the remote control unit, verify that the BUSY indicator is turned off.

Setting Mode menu items are as shown below.

MENU indication	Description	Reference
NETWORK	Changes the IP address of the remote control unit and displays the PC-LAN network information.	5-4-4-1
VER/ALARM	Displays version and alarm information.	5-4-4-2
DEFAULT	Changes the default settings that are loaded when the remote control unit is powered on.	5-4-4-3
BUTTON ASSIGN	Assigns functions to user-assignable buttons.	5-4-4-4
INHIBIT	Enables/disables the INHIBIT function for channels.	5-4-4-5
NAME TYPE	Selects the display type for Destination, Source and Level.	5-4-4-6
BRIGHTNESS	Sets the brightness of buttons.	5-4-4-7
RU-RU CONNECT	Configures link systems for multiple remote control units.	5-4-4-8
TENKEY	Sets TENKEY (Ten-key keypad) operation.	5-4-4-9
PAGE	Changes PAGE settings.	5-4-4-10
SALVO CLEAR	Clears stored salvo data in buttons.	5-4-4-11

5-4-4-1. NETWORK

The following submenus are available in NETWORK setting mode.

Submenu	Description
RU NETWORK	Changes the remote control unit IP address and displays the network information.
PC-LAN NETWORK	Displays the PC-LAN port network settings.
PC-LAN REBOOT	Restarts the PC-LAN port. * Disabled if connecting to MFR-4000 units.

NETWORK > RU NETWORK

Menu item	Description
IP	Displays and changes the remote control unit IP address. The lower 8 bits (the fourth byte) represent the Unit ID.
MASK	Displays the remote control unit subnet mask.
UNIT NAME	Displays the remote control unit name.

To Change IP Address:

1. Hold down the button where the number to be changed is displayed. The button blinks.
2. Turn **CONTROL** to change the number.
3. Repeat 1. and 2. to change the IP address.
4. Hold down the current **DEST** button to confirm the change. The remote control unit automatically restarts.

NETWORK > PC-LAN NETWORK

Menu item	Description
IP	Displays the PC-LAN IP address.
MASK	Displays the PC-LAN subnet mask.
GW	Displays the PC-LAN Default Gateway IP address.

NETWORK > PC-LAN REBOOT

To restart the PC-LAN port:

* Disabled if connecting to MFR-4000 units.

1. Press REBOOT.
2. Hold down **EXEC HOLD 1s** to restart the PC-LAN port. "STARTUP" and "NOW" is displayed during restart.

5-4-4-2. VER/ALARM

◆ Menu List

Menu item	Description
VERSION	Displays the firmware version.
PS1	Displays the AC adapter 1 status.
PS2	Displays the AC adapter 2 status.
TEMPERATURE	Displays the temperature.
VOLTAGE	Displays the voltage status.

5-4-4-3. DEFAULT

◆ Menu List

Menu item	Description	Set by
MODE	Selects a mode when the remote control unit is powered on. DEST: Destination mode SRC: Source mode LEVEL: Level mode PAGE ALL: Page mode (all groups) PAGE GROUP A: Page mode (Group A) PAGE GROUP B: Page mode (Group B) PAGE GROUP C: Page mode (Group C) PAGE GROUP D: Page mode (Group D) SETTING: Setting mode	Pressing a button
DEST	Selects a destination channel when the remote control unit is powered on.	CONTROL
LEVEL	Selects a level when the remote control unit is powered on.	Pressing a button
PAGE	LAST: When the remote control unit is powered on, the RU displays the page that was last displayed before shutdown. SELECT: When the remote control unit is powered on, the RU displays the page that was set by SELECT	Pressing a button
	When SELECT is selected, following groups are displayed. GRP A: Selecting a page from Group A. GRP B: Selecting a page from Group B. GRP C: Selecting a page from Group C. GRP D: Selecting a page from Group D.	CONTROL

5-4-4-4. BUTTON ASSIGN

This menu displays the assignment list for PAGE 1.

Changing Assign Functions to Buttons:

1. Turn **CONTROL** to select a page.
2. Press a button for assignment. The button blinks and its information is displayed.
3. Turn **CONTROL** to select a function to assign the button.
4. Use **CONTROL** to set the corresponding parameter(s). Once the settings are complete, the current **DEST** button blinks and "SAVE" is displayed on the button.
5. Press the current **DEST** button to confirm the settings.

To perform another assignment, proceed from Step 1.

FUNC Menu List

FUNC	Parameter	Description	Remarks
NONE			
DEST	DESTINATION	Destination channel	
	LEVEL	Level (Available level numbers are displayed.)	
SRC	SOURCE	Source channel	
	LEVEL	Level (Available level numbers are displayed.)	
BUS	DESTINATION	Destination channel	
	SOURCE	Source channel	
	LEVEL	Level (Available level numbers are displayed.)	
PAGE	TYPE	JUMP : Moves to the specified page. UP : One page forward DOWN : One page backward	
	FORWARD	A page no. to jump	When TYPE is set to JUMP :
	REVERSE	A page no. to return HOME : Return to home	
	GROUP	Page group selection	
MODE	TARGET	Mode selection using the MODE button	
LOCK	TYPE[S]	Short-press Lock mode selection of the LOCK button.	
	DESTINATION[S]	Short-press Destination channel setting of destination buttons. CURRENT : Locks the current destination	When ALL or OTHER is set for TYPE[S]:
	TYPE[L]	Long-press Lock mode selection of the LOCK button.	
	DESTINATION[L]	Long-press Destination channel setting of destination buttons. CURRENT : Locks the current destination	When ALL or OTHER is set for TYPE[L]:
TAKE			
LEVEL		Level (Available level numbers are displayed.)	
LINK			
TENKEY			

FUNC	Parameter	Description	Remarks
SKIP	BWD/FWD	Mode selection	
	COUNT	Number to be skipped	
MON-OUT	NO.	MONITOR OUT port number of main unit rear panel.	MFR-5000/ 8000 only
O-PREV	DESTINATION	Destination channel	
SALVO	TYPE	MU: Execution of an MU salvo. RU: Execution of an RU button salvo STORE: Registration of an MU salvo	
	NO.	Salvo number	When TYPE is set to MU or RU:

5-4-4-5. INHIBIT

The following submenus are available in INHIBIT Setting mode.

Submenu	Description
DEST	Sets INHIBIT to enabled/ disabled for a destination channels. "X" appears on channels with INHIBIT enabled.
SRC	Sets INHIBIT to enabled/ disabled for a source channels. "X" appears on channels with INHIBIT enabled.

INHIBIT > DEST

Displays a list of destination channels. Press a channel to enable/disable INHIBIT.

INHIBIT > SRC











Displays a list of source channels. Press a channel to enable/disable INHIBIT.

5-4-4-6. NAME TYPE

Menu List

Menu Item	Description	Set by
DEST	Selects a display format for a destination button.	Pressing a button
SRC	Selects a display format for a source button.	Pressing a button
LEVEL	Selects a display format for a level button.	Pressing a button
DEST BITMAP	Selects USE / UNUSE a destination button bitmap image.	Pressing a button
SRC BITMAP	Selects USE / UNUSE a source button bitmap image.	Pressing a button

Available formats are as shown in the table below.

Display format	Description	Display example		
		DST	SRC	LEVEL
PHY NUM	Physical number display			
ASCII	Ascii character display (Alphanumeric characters and symbols)			
KANJI	2-byte character code including 1-byte character code (Not selectable for LEVEL)			
BITMAP	Bitmap image (saved in the RU) display			

- * When using 2-byte characters:
Up to 8 characters (including one-byte characters) on MFR-18RUA/39RUA/16RUTA/8RUA units
Up to 4 characters (including one-byte characters) on MFR-18RU/39RU units
- * Up to 14 characters when using only one-byte characters
- * Only 52x36 size black-and-white BMP images are displayed.
Bitmap images registered using off-line GUIs.

5-4-4-7. BRIGHTNESS

Menu List

Menu item	Description	Set by
BUTTON	Selects button brightness.	Pressing a button
LOW LIGHT	Select between NORMAL and LOWLIGHT for dim lighting.	Pressing a button

5-4-4-8. RU-RU CONNECT

Menu List

Menu item	Description	Set by
CONNECT	Enables /disables the link connections between remote control units.	Pressing a button
MASTER ID	Selects a link ID.	CONTROL

5-4-4-9. TENKEY

Menu List

Menu item	Description	Set by
INPUT MODE	Selects the confirmation method when using the Ten-key keypad. DIRECT : Confirms setting by pressing Ten-key keys. ENTER : Confirms setting by pressing Ten-key keys then pressing ENTER.	Pressing a button
START	Selects 0 or 1 for a Ten-key keypad mode start point.	Pressing a button

5-4-4-10. PAGE

Menu List

Menu item	Description	Set by
MODE	Selects CONTROL behavior in Page mode. UP/DOWN : Turn CONTROL to move one page forward/backward. JUMP : Turn and press CONTROL to select and move to the page.	Pressing a button
ASSIGN	Selects PAGE button assignment. ONE PAGE : Assigns PAGE buttons to specified pages. ALL PAGES : Assigns PAGE buttons to all pages respectively.	Pressing a button
DISPLAY	Selects whether to display unit names for Current PAGE displays (C/D). PAGE C&D : Current PAGE display for Group C and D. UNIT NAME : Displays unit names.	Pressing a button
WRAPAROUND	Turns ON or OFF Wraparound when changing a page using CONTROL or PAGE UP/DOWN button. ON : When a page is switched to Page MAX, next page is continued as Page 1 to Page 2...as a continuous circular series. OFF : Wraparound is turned off.	Pressing a button

5-4-4-11. SALVO CLEAR

This menu displays the button-assigned salvo list and allows you to clear salvos.

To Clear a Button-assigned Salvo:

1. Press to clear a salvo button. The button starts blinking and **CLEAR** is displayed on the current **DEST** button.
2. Press the current **DEST** button.

5-5. Operation Using the Menu Display (MFR-16RUD)

The MFR-16RUD, a remote control unit with display, allows you to select destination channels and switch crosspoints using the menu display. Function button assignments are also possible.

◆ Default Display

The Current Destination Channel name is displayed on the first line.

The Source Channel name selected for Current Destination is displayed on the second line.

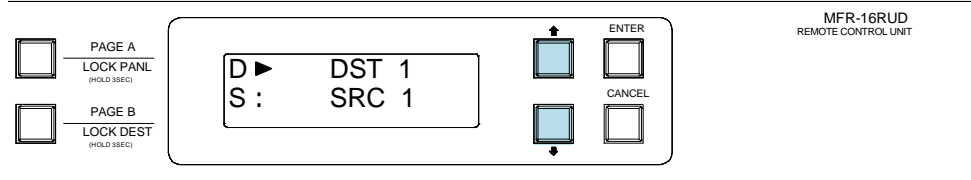

5-5-1. Crosspoint Switching

To switch crosspoints on the MFR-16RUD using the menu display, proceed as follows:

1. Press the **UP** or **DOWN** button to display current destination. (DST 5 in this example)

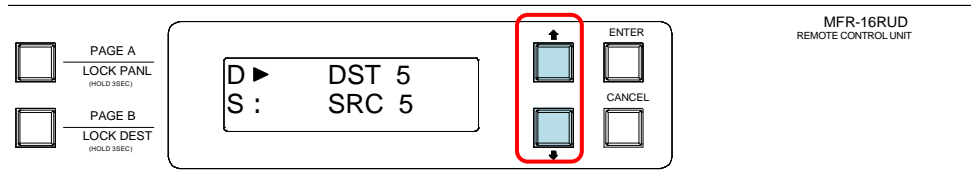

2. Press **ENTER**.

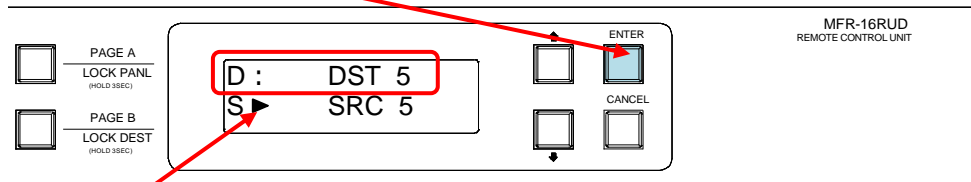

3. The cursor automatically moves to the second line (Source side). Press **UP** or **DOWN** to select a source channel.

Note that source name blinks during a selection.

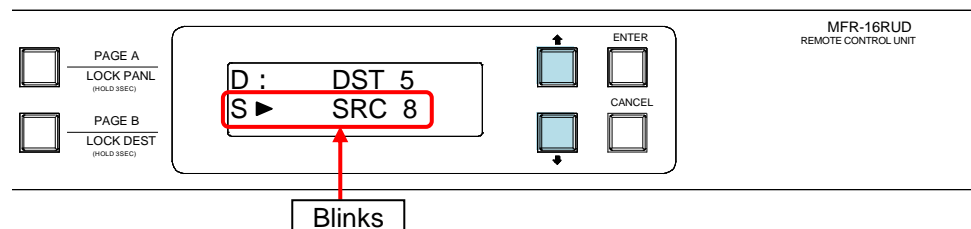

- Press **ENTER** to perform the crosspoint switch. The screen will return to the default display.

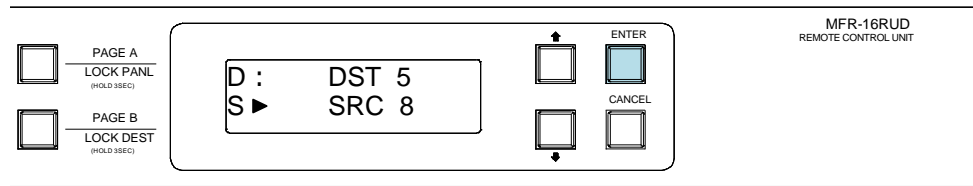

5-5-2. Changing Button Assignment

To change button assignments using the menu display, proceed as follows:

- Press a button while holding down **ENTER**. The button starts blinking.

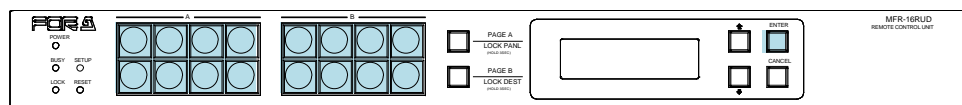

The first line displays the button function and its currently assigned parameter. The second line displays parameter's detailed information.

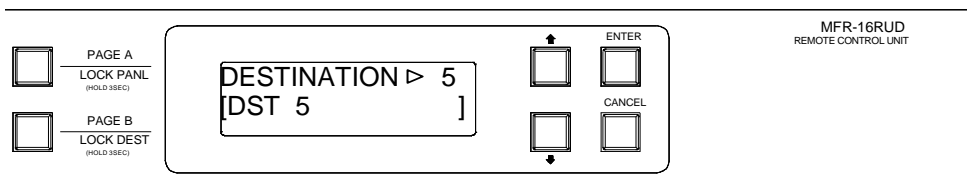

- Press **UP** or **DOWN** to select a function to be assigned. Press **ENTER** to apply the change.

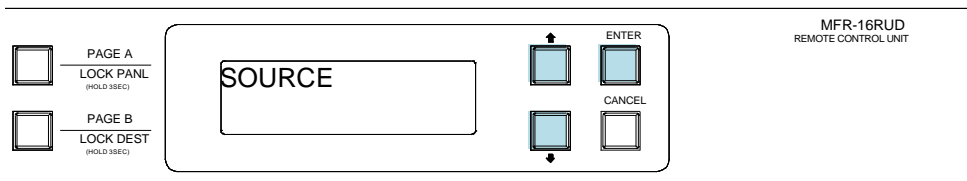

- The display changes to the parameter selection according to the selected function. Press **UP** or **DOWN** to select the parameter value. Press **ENTER** to confirm the selection. The cursor will move to the next parameter if two or more parameters exist. Set the value and press **ENTER** in the same way, accordingly. Note that parameters keep blinking during the selection.

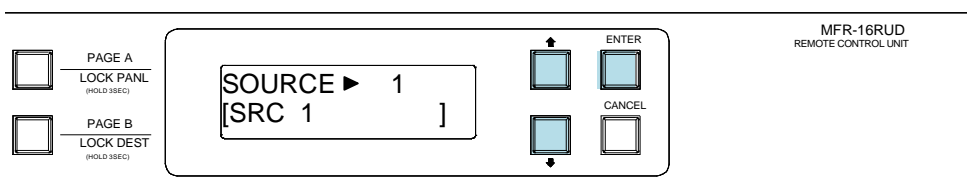

When all settings are finished, the menu display automatically returns to its default display.

◆ Assignable Function/Parameter List

Function	Parameter	Description
(NONE)	None	
DESTINATION	DESTINATION ▶ XXX (XXX: Destination Channel number)	
SOURCE	SOURCE ▶ YYYY (YYYY: Source Channel number)	
BUS	BUS D ▶ XXX S ▷ YYYY (XXX: Destination Channel number YYYY: Source Channel number)	
LOCK	LOCK ^S ▶ XXX ▷ YYY (Lock function by short press) LOCK ^L ▶ XXX ▷ YYY (Lock function by long press) (XXX: OTH LOCK OTHER /ALL LOCK ALL /LOC LOCK LOCAL /NON No lock YYY: CUR Current Destination /Destination Channel number) YYY is effective only when XXX is set to OTHER or ALL.	
TAKE	None	
LINK	None	
MON-OUT	MON-OUT ▶ X (X: MONITOR OUT number)	*MFR-5000 /8000 only
PREVIEW	PREVIEW ▶ XXX (XXX: Destination Channel number)	
SALVO	SALVO ▶ XX ▷ YYYY (XX : MU Main Unit Stored Salvo /RU Remote control unit Button Assigned Salvo YYYY: Salvo number)	

5-6. Setup Menu (MFR-16/40RU, MFR-16RUD, MFR-16/32/64RUW)

The **SETUP** button allows you to enter **Setup Menu** mode, in which RU and MU PC-LAN network settings are displayed, the MU-PC LAN port can be rebooted, and RU network settings can be changed. To exit **Setup Menu** mode, press the **SETUP** button again.

◆ IP Address Display

The following procedure shows how to display an IP address in **Setup Menu** mode using MFR-16RU as an example.

1. Press **SETUP**. All indicators, POWER, BUSY and LOCK, turn orange to indicate that the RU enters in **Setup Menu** mode.
2. Press Button **D**. (If Button **B** or **C** is lit, press the lit button.)
3. Press the leftmost button (the first octet) of buttons **H**.
The numbers are displayed on buttons **I**. If the MFR-16RU IP address is set to "192.168.1.100," the eight (8 bit) buttons display "192" (128+64) by turning the light **On** or **Off** for each bit (On, On, Off, Off, Off, Off, Off, Off).

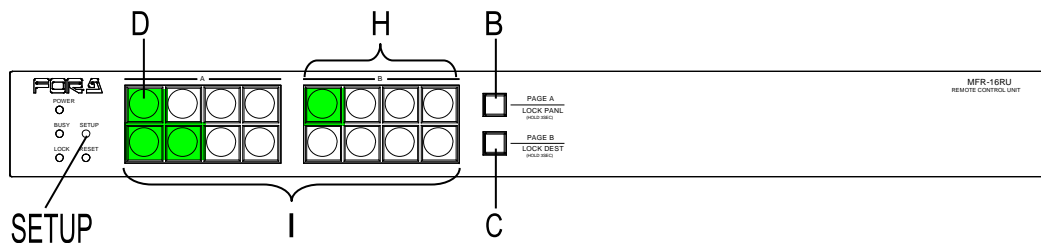

4. Press the second button (the second octet) of buttons **H**.
The number is displayed on buttons **I**.
If the MFR-16RU IP address is set to "192.168.1.100," "168" is displayed.
5. Press the third button (the third octet) of buttons **H**.
The number is displayed on buttons **I**.
If the MFR-16RU IP address is set to "192.168.1.100," "1" is displayed.
6. Press the right-most button (the fourth octet) of buttons **H**.
The number is displayed on buttons **I**.
If the MFR-16RU IP address is set to "192.168.1.100," "100" (64+32+4) is displayed as shown below (Off, On, On, Off, Off, On, Off, Off).

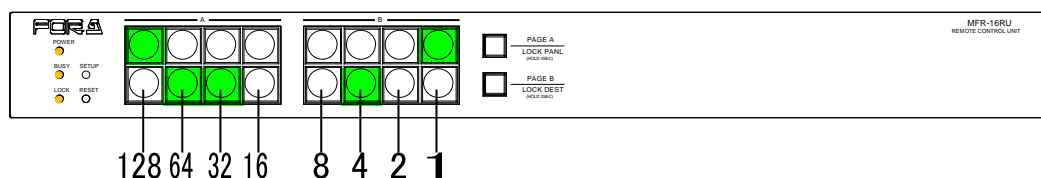

5-6-1. Displaying Network Settings

- In **Setup Menu** mode, press buttons as shown in the table below to display desired network settings. Note that button locations vary depending on remote control units as shown below.

Button operation		LAN port	Display Info.
Press D.	If B is lit, press B. If C is lit, press C.	Remote Control Unit (LAN)	IP address
Press E.	If B is lit, press B. If C is lit, press C.		Subnet mask
Press B, then D.		PC-LAN on Main Unit (MU)	IP address
Press B, then E.			Subnet mask
Press B, then F.			Default Gateway

- Press to select an octet button of buttons **H**. The rightmost button represents the fourth octet. (See the previous page.)
- The octet value is displayed on buttons **I** (eight buttons). (See the previous page.)

MFR-16RU (MFR-16RUD)

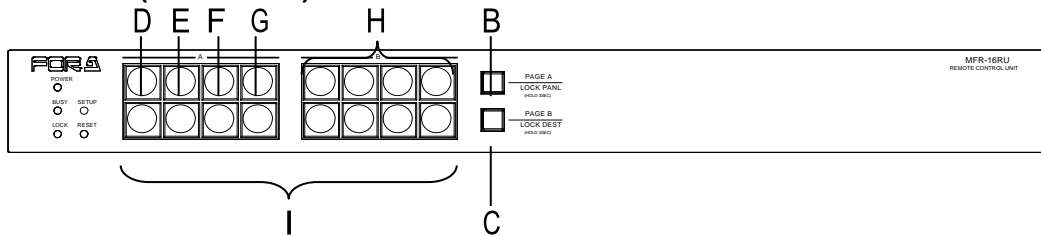

MFR-40RU

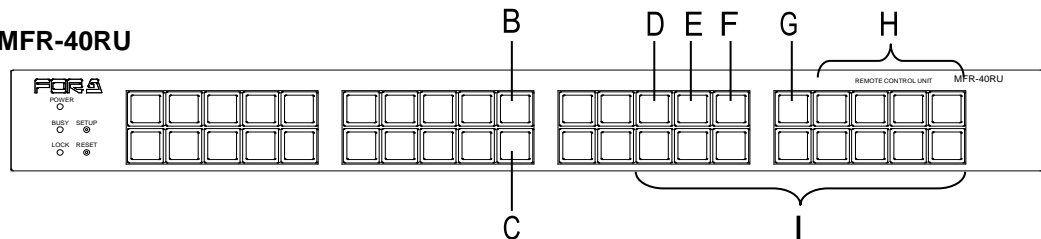

MFR-16RUW

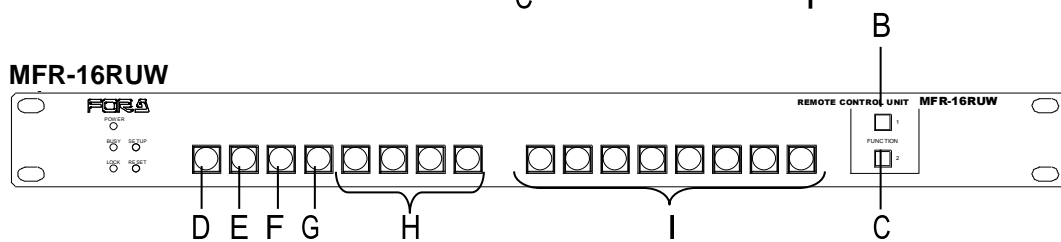

MFR-32RUW

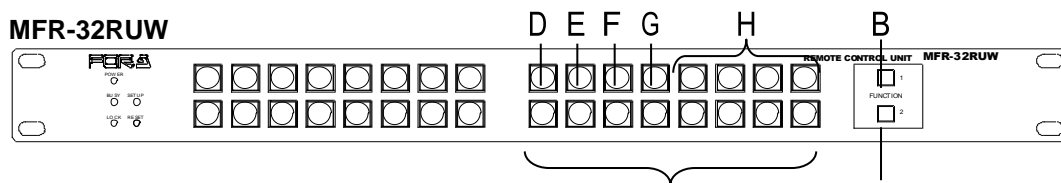

MFR-64RUW

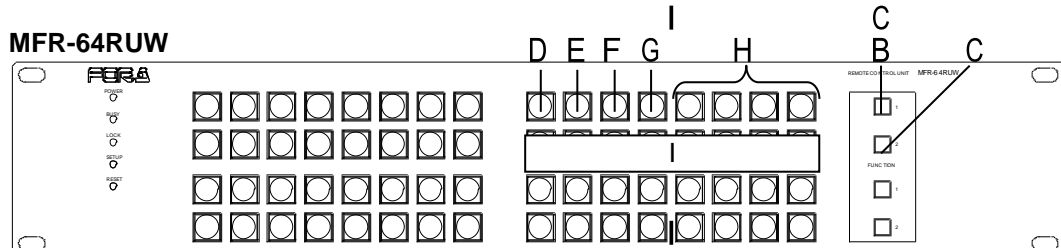

5-6-2. Changing the RU IP Address

The RU IP address can be changed, such as in the example procedure below, which changes the MFR-16RU IP address from "192.168.1.100" to "192.168.1.101."

Button locations vary depending on remote control units. Refer to the previous page for other remote control unit button locations.

1. Press Button **D** in **Setup Menu** mode. (If Button **B** or **C** is lit, press the lit button.)
2. Press and **hold down** the **right-most** button (the fourth octet) of buttons **H**. The button starts blinking and the bottom eight buttons (Buttons **I**) display the value (100) by turning the light **On** and **Off**.

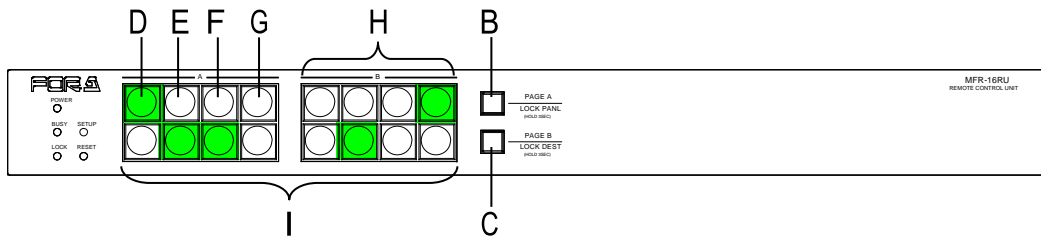

3. On the bottom row, press the rightmost button of buttons **I** to turn on the button and change the octet value to "101" ($64+32+4+1$).

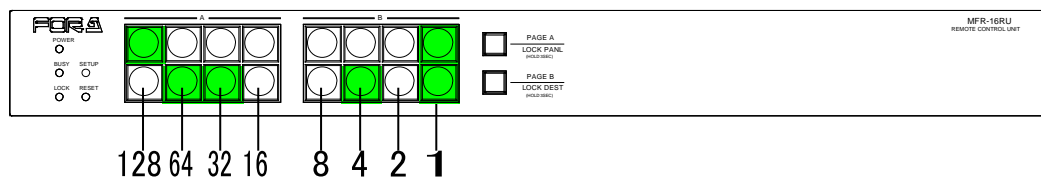

To change the first, second or third octet value, repeat steps 2. and 3., respectively.

To clear an octet value, press and hold down the blinking octet selection button on the upper row.

4. When a value is changed, button **G** blinks. Press and hold down **G** to confirm the change. The remote control unit automatically restarts. To cancel the process, press Button **B** or **C** without pressing **G**.

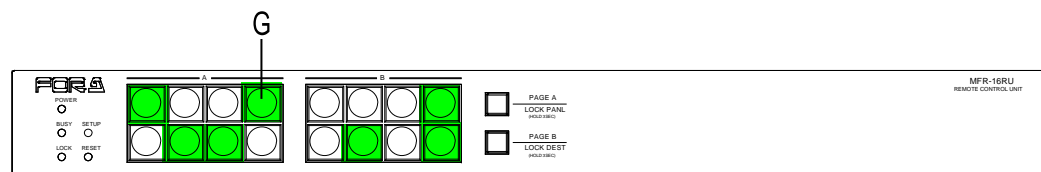

5-6-3. Rebooting MU PC-LAN

1. Press button **C** in **Setup Menu** mode.
 2. Press and hold down button **K**. Button **L** (EXEC button) starts blinking.
 3. Press and hold down button **L** to reboot MU PC-LAN. Buttons **I** keep blinking while rebooting and turn off when the reboot is complete.
- * Disabled if connecting to MFR-4000 units.

MFR-16RU (MFR-16RUD)

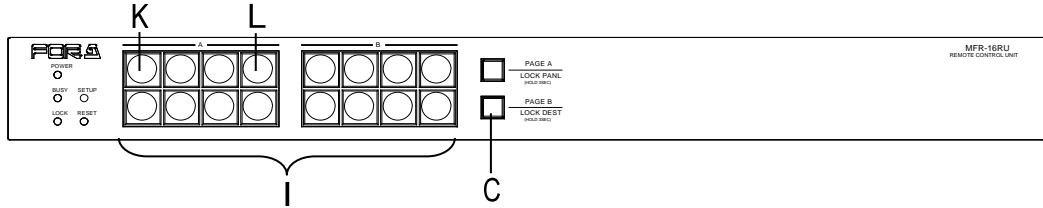

MFR-40RU

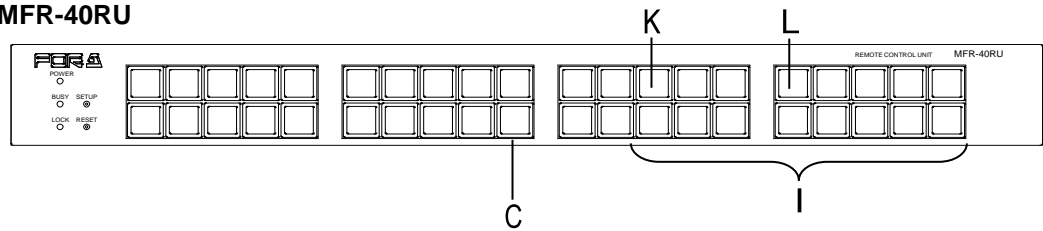

MFR-16RUW

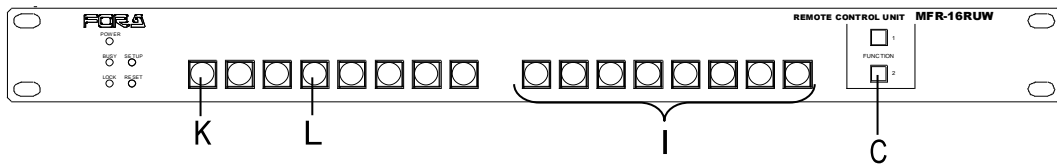

MFR-32RUW

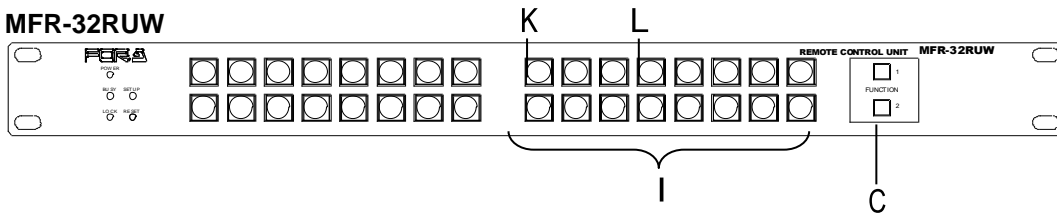

MFR-64RUW

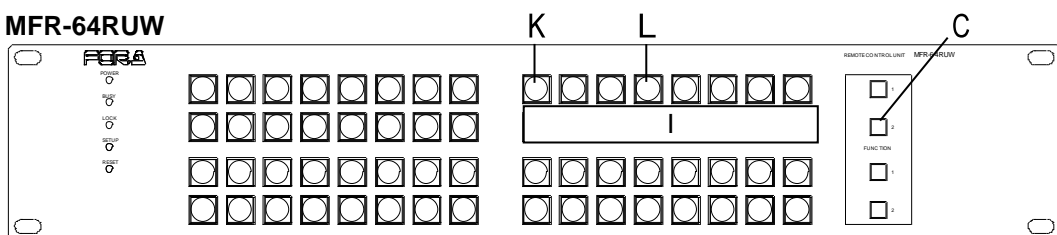

5-7. Setup Menu (MFR-18RU/18RUA)

The **SETUP** button allows you to enter **Setup Menu** mode, in which RU and MU PC-LAN network settings are displayed, the MU-PC LAN port can be rebooted, and RU network settings can be changed. The left three buttons are used to select information to be displayed or select PC-LAN reboot. To exit **Setup Menu** mode, press the **SETUP** button again.

Selection buttons (See the figures below)	LAN Port	Display / Execution
Button A	Remote Control Unit (RU)	IP address display and change
		Subnet mask display
Button B	PC-LAN on Main Unit (MU)	IP address display
		Subnet mask display
		Default gateway display
Button C	PC-LAN on Main Unit (MU)	Reboot

5-7-1. Displaying Network Settings

◆ To Display RU IP Address and Subnet Mask Settings

Press **SETUP** to enter **Setup Menu** mode. RU IP address and subnet mask settings are displayed as shown below. (If button A is off (unlit), press button A.)

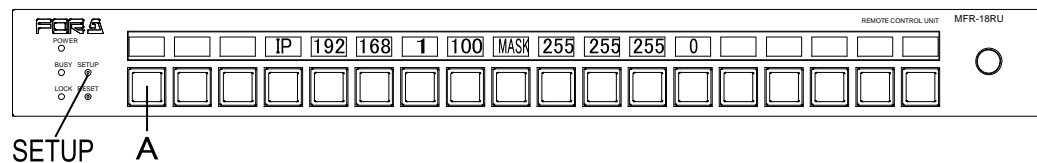

◆ To Display IP address, Subnet Mask and Default Gateway of MU PC-LAN

Press button **B** in **Setup Menu** mode. Network settings are displayed as shown below, in the order, "IP address, Subnet Mask and Default Gateway."

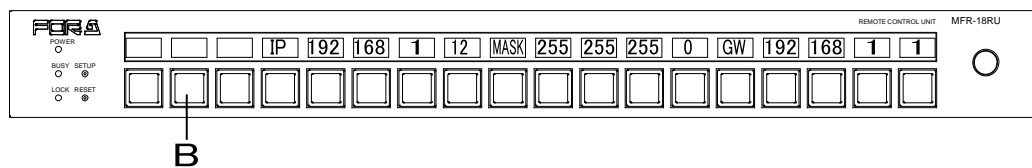

5-7-2. Changing the RU Network Settings

The RU IP address can be changed, such as in the example procedure below, which changes the MFR-18RU IP address from "192.168.1.100" to "192.168.1.101."

1. Press **SETUP** to enter **Setup Menu** mode. RU IP address and subnet mask settings are displayed as shown below. (If other information is displayed, press Button **A**.)
2. Press and hold down the button below "100." The number starts blinking.

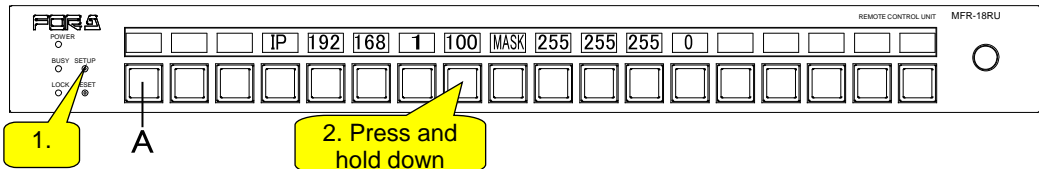

3. Turn **CONTROL** to change the value to **101**. To clear the number setting, press and hold down the button.
4. When the number is changed, the **SAVE** button blinks. Press and hold down **SAVE** to confirm the change. The remote control unit automatically restarts. To cancel the process, press other button (**A-C**) without pressing **SAVE**.

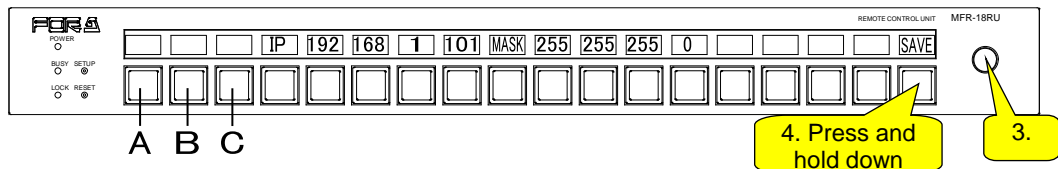

5-7-3. Rebooting MU PC-LAN

1. Press button **C** in **Setup Menu** mode.
 2. Press and hold down the **REBOOT** button. The **EXEC** button appears.
 3. Press and hold down **EXEC** to reboot MU PC LAN. The "PC-LAN" and "Startup" messages are displayed while rebooting. The message disappears when the reboot is complete.
- * Disabled if connecting to MFR-4000 units.

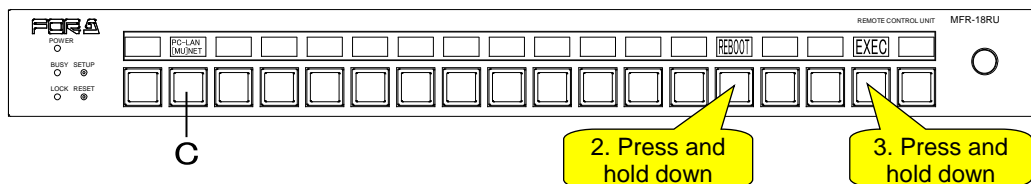

5-8. Setup Menu (MFR-39RU)

The **SETUP** button allows you to use the **Setup Menu**. Follow the procedure below.

1. Turn and press **CONTROL** to confirm a submenu selection.
2. Turn and press **CONTROL** to select and confirm a parameter.

◆ Setup Menu Sub-menu List

Menu		Parameter	Description
IP ADDRESS[RU]		-	Sets the IP address for the remote control unit. The last 8 bits are the unit ID. (See Sec. 5-8-1.)
SUBNET MASK[RU]		-	Displays the subnet mask setting in the remote control unit.
PC-LAN[MU]	NET		Displays the network settings (IP address, subnet mask, gateway)
	GUI REBOOT		Reboots PC-LAN.
RU CONN ID *		-	Sets the ID to recognize connected remote control units used in link operation. (See Sec. 5-12-2.)
RU CONNECT *		ON OFF	Selects whether to connect and link multiple remote control units.
BRIGHTNESS		1(dark)~8 (bright)	Sets the brightness for buttons, LCD and the menu display.
BTN ASSIGN		-	Assigns functions to buttons. The same functions as those assignable in the Setting mode BTN ASSIGN menu are available. (See Sec. 5-4-3-2)
VER/ALARM		-	Displays version and alarm information.
REBOOT		YES NO	Select YES and press CONTROL to start rebooting.
EXIT		-	Allows you to exit the Setup Menu . The display returns to the one before entering the Setup Menu . (The CANCEL button works the same way.)

* Do not turn off the remote control unit until the **BUSY** indicator, which lights orange, goes off when changing modes. Doing so will disable the change.

5-8-1. IP ADDRESS [RU]

This menu changes the IP address of remote control units. The last 8 bits (the 4th byte) are the unit ID.

```

SETUP>IP ADDRESS[RU]
192.168.001.100<ENT>

```

Turn **CONTROL** to select a byte to be changed. The selected byte will be highlighted. After changing the value, press **CONTROL**. The next byte to be changed will be highlighted.

```

SETUP>IP ADDRESS
192.168.001.100<ENT>

```

Pressing **CONTROL** while the 4th byte is highlighted highlights the whole IP address, and the changed IP address is saved. Press **CONTROL** again. A message appears to ask whether to restart the remote control unit. Select **YES** and press **CONTROL** to restart the remote control unit with the new IP address.

IMPORTANT

The saved IP address is applied when the remote control unit restarts. Selecting NO necessitates a manual restart of the remote control unit to apply the new IP address. The IP address must not conflict with the IP address of the MFR main unit or other remote control units.

5-9. Setup Menu (MFR-39RUA)

The **SETUP** button allows you to enter **Setup Menu** mode, in which menu settings can be performed as shown in Sec. 5-4-4. "Setting Mode Menu (MFR-39RUA)." See Sec. 5-4-4. for details.

5-10. Setup Menu (MFR-16RUTA)

The **SETUP** button allows you to enter **Setup Menu** mode, in which RU and MU PC-LAN network settings are displayed, the MU PC-LAN port can be rebooted, and RU network settings can be changed. The left three buttons are used to select information to be displayed or the PC-LAN reboot. The fourth button from the left is used to switch network information display. To exit **Setup Menu** mode, repress the **SETUP** button.

Selection buttons (See the figures below)	LAN Port	Display / Execution
Button A	Remote Control Unit (RU)	IP address display and change
		Subnet mask display
Button B	PC-LAN on Main Unit (MU)	IP address display
		Subnet mask display
		Default gateway display
Button C	PC-LAN on Main Unit (MU)	Reboot
Button D	If button A or B is selected	Display item change

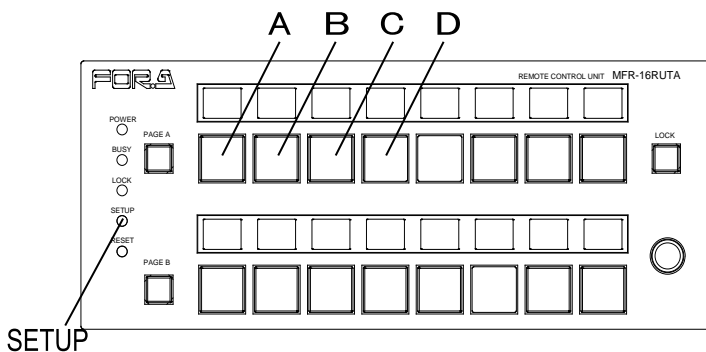

5-10-1. Displaying Network Settings

◆ To Display RU IP Address and Subnet Mask Settings

Press **SETUP** to enter **Setup Menu** mode. (If button **A** is off (unlit), press button **A**.)
Pressing button **D** displays the RU IP address and repressing it displays the subnet mask.

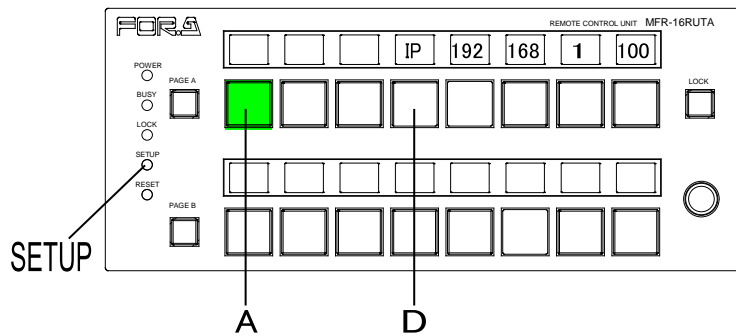

◆ To Display IP address, Subnet Mask and Default Gateway Settings of MU PC-LAN

Press button **B** in **Setup Menu** mode. The IP address, subnet mask and default gateway are successively displayed by pressing button **D**.

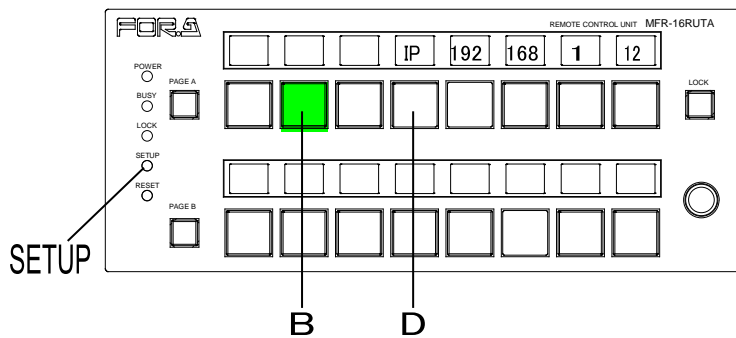

5-10-2. Changing the RU Network Settings

1. Press **SETUP** to enter **Setup Menu** mode. (Press button **A** if other information is displayed.)
2. Press and hold down a button under the number to be changed. The number blinks.

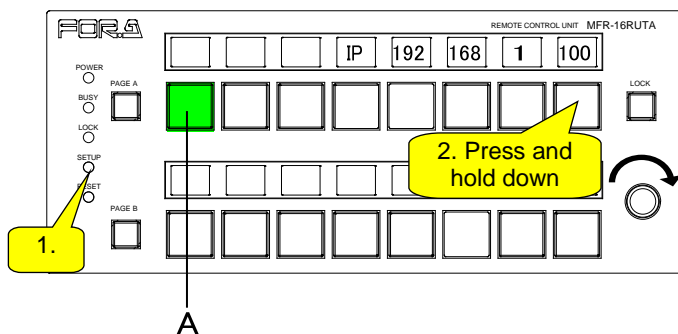

- Turn **CONTROL** to change the value to **101**. To clear the number setting, press and hold down the button.
- When a number is changed, the **SAVE** button blinks. Press and hold down **SAVE** to confirm the change. The remote control unit will automatically restart.
To cancel the process, press other button (A to C) without pressing **SAVE**.

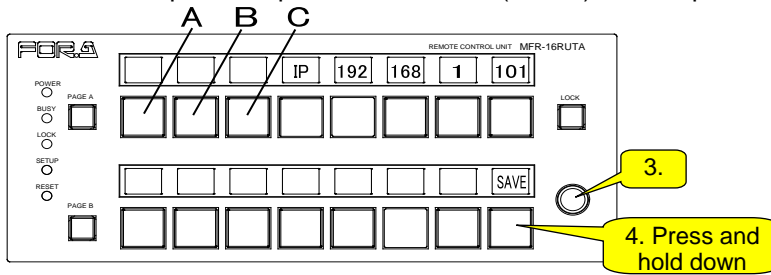

5-10-3. Rebooting MU PC-LAN

- Press button **C** in **Setup Menu** mode.
 - Press and hold down the **REBOOT** button shown below. The **EXEC** display appears.
 - Press and hold down the button under **EXEC** to reboot MU PC-LAN. The "PC-LAN" and "Startup" messages are displayed during rebooting and disappears when the reboot is complete.
- * Disabled if connecting to MFR-4000 units.

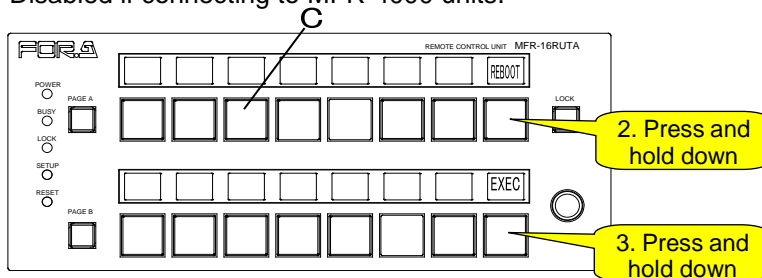

5-11. Setup Menu (MFR-8RUA)

The **SETUP** button allows you to enter **Setup Menu** mode, in which RU and MU PC-LAN network settings are displayed, the MU PC-LAN port can be rebooted, and RU network settings can be changed. The left two buttons are used to select information to be displayed or the PC-LAN reboot. The third button from the left is used to switch network information display. To exit **Setup Menu** mode, press the **SETUP** button again.

Selection buttons (See the figures below)	LAN Port	Display / Execution
Button A	Remote Control Unit (RU)	IP address display and change
		Subnet mask display
	PC-LAN on Main Unit (MU)	IP address display
		Subnet mask display
Button B	PC-LAN on Main Unit (MU)	Reboot
Button C	If button A is selected	Display item change

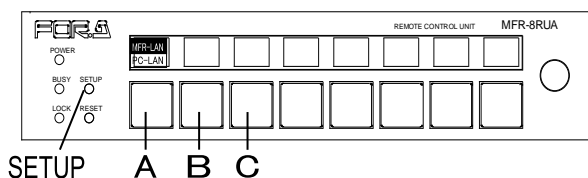

5-11-1. Displaying Network Settings

1. Press **SETUP**.
2. Press Button **A** to select MFR-LAN or PC-LAN. The selected item appears white and background turns dark. Select **MFR-LAN** to display RU IP address and subnet mask. (The figure below shows the display when **MFR-LAN** is selected.)

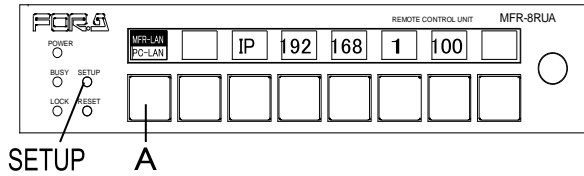

3. Press button **C** to switch displaying network information. (The figure below shows RU subnet mask.)

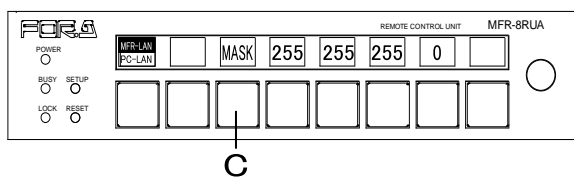

5-11-2. Changing the RU Network Settings

The following procedure shows how to change IP address from 192.168.1.100 to 192.168.1.101 as an example.

1. Press **SETUP** to display RU IP address. (Press button **A** if other information is displayed.)
2. Press and hold down the button under "100." The number blinks.

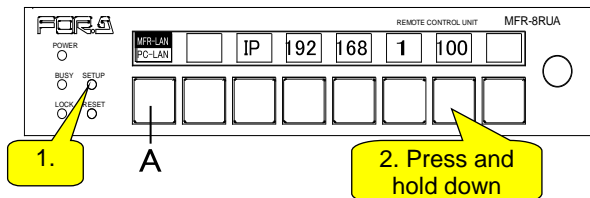

3. Turn **CONTROL** to change the value to **101**. To clear the number setting, press and hold down the button.
4. When a number is changed, the **SAVE** button blinks. Press and hold down **SAVE** to confirm the change. The remote control unit will automatically restart. To cancel the process, press **A** or **B** without pressing **SAVE**.

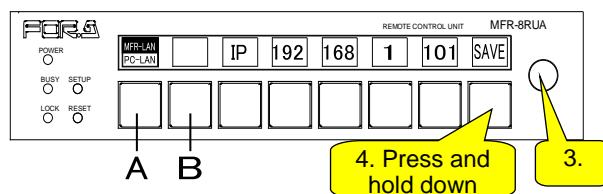

5-11-3. Rebooting MU PC-LAN

1. Press button **B** in **Setup Menu** mode.
 2. Press and hold down the **REBOOT** button shown below. The word **EXEC** appears.
 3. Press and hold down the button under **EXEC** to reboot PC-LAN. The "PC-LAN" and "Startup" messages are displayed during rebooting and disappears when the reboot is complete.
- * Disabled if connecting to MFR-4000 units.

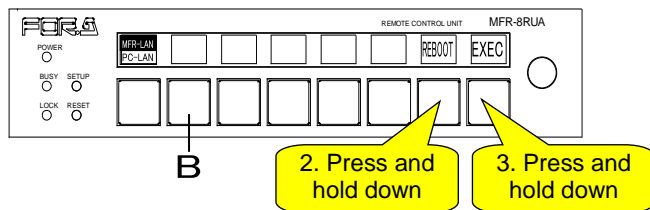

5-12. Multi-Panel Operation

5-12-1. Outline

Multiple remote control units can be connected to build a large control panel system.

IMPORTANT

Up to 5 remote control units can be linked together.

(Ex.) To build a 96 x 96 maximum control system,

Units to use: MFR-40RU x 4, and MFR-39RU x 1

Configuration

Destination button assignments to: MFR-40RU x 2 and a part of MFR-39RU

Source button assignments to: MFR-40RU x 2 and a part of MFR-39RU

This system can control 96 x 96 inputs and outputs without using the PAGE function.

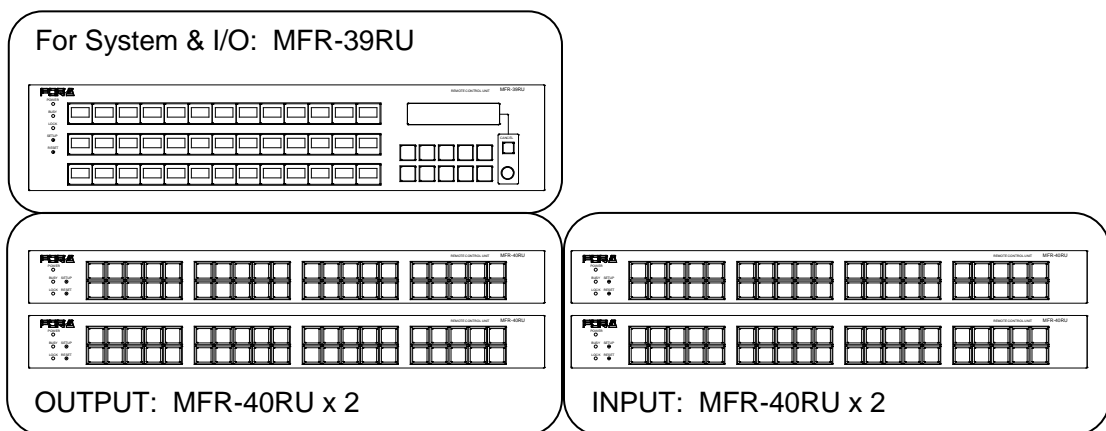

◆ Functions that can be integrated

The following operational procedures can be integrated between the connected remote control units using the interlock function.

- To select destination channels
- To select destination/source channels and levels using **CONTROL**.
- To enable or disable Lock functions (LOCK LOCAL, LOCK OTHER, and LOCK ALL)

• Lock functions in the multi-panel operation

All connected remote control units work as one remote control unit, so:

LOCK LOCAL: All integrated remote control units are locked locally.

LOCK OTHER: Restricts remote control units other than those in the multi-panel operation system from changing crosspoints.

All integrated remote control units can unlock the Lock function.

LOCK ALL: Restricts all units within the multi-panel operation system from changing crosspoints.

All integrated remote control units can unlock the Lock function.

5-12-2. Enabling Multi-Panel Operation

Multi-panel operation can be enabled in the **Setup Menu** or in the [Web-Based Control: **RU Settings** page].

The procedure enabling multi-panel operation in the **Setup Menu** is as shown below. (Supported only by MFR-39RU/39RUA)

◆ MFR-39RU

Step	Description
1	Press the SETUP button to enter the Setup Menu .
2	Turn and press the CONTROL knob to select and confirm RU CONN ID . <div style="border: 1px solid black; padding: 5px; margin: 10px auto; width: fit-content;"> SETUP>RU CONN ID UNIT ID: 0<ENT> </div> Menu display
3	Turn CONTROL to select the ID, and press the knob to confirm. ID: This ID is used to synchronize remote control units for multi-panel operation. All panels must have the same ID as that of the master remote control unit ID of the system. (ex.) To enable multi-panel operation using a master remote control unit whose unit ID is 100, set all integrated remote control unit IDs to 100.
4	Press the CANCEL button to return the menu display to select menus. Turn and press the CONTROL knob to select and confirm RU CONNECT . <div style="border: 1px solid black; padding: 5px; margin: 10px auto; width: fit-content;"> SETUP>RU CONNECT ENABLE:OFF<ENT> </div> Menu display
5	Turn and press the CONTROL knob to select and confirm ON .

◆ MFR-39RUA

Step	Description	Refer to
1	Press SETUP to enter the Setup Menu .	
2	Press RU-RU CONNECT .	
3	Change CONNECT to ENABLE .	5-4-4-8
4	Turn CONTROL to select a link ID under MASTER ID . * The link ID is used to configure a link of multiple remote control units and is equal to the unit ID of the master unit in the remote control unit link. To configure the remote control unit link using the master unit having Unit ID 100, set other remote control unit MASTER IDs to 100 within the link system.	5-4-4-8
5	To exit Setup Menu mode, press EXIT twice.	

Perform the above procedure for each remote control unit to be integrated.

To enable multi-panel operation in Web-Based Control, proceed as follows:

1. Click the remote control unit to display the menu tree. Select **RU Settings** to display the menu.
2. Set the master remote control unit Unit ID under **Master ID** (for RU Linkage).
3. Set **RU Linkage** to **ON**.

6. Crosspoint Control

6-1. Single Crosspoint Switching

There are two ways of switching crosspoints: Switching a crosspoint one at a time, or switching multiple crosspoints simultaneously. This section describes the switching of a single crosspoint.

6-1-1. Single Crosspoint Switching by X-Y Setting

A crosspoint can be switched using destination and source buttons on the remote control unit. Destination and source channels must be assigned to those buttons beforehand.

(Ex.) The following procedure outputs source channel 8 to destination channel 4.

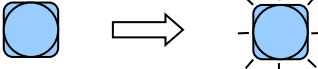
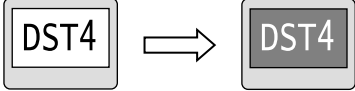
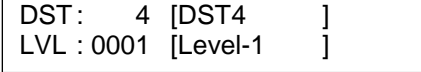
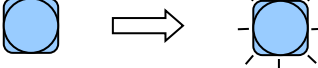
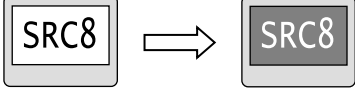
Step	Description	Indications
1	Press a destination button to select destination channel 4.	<ul style="list-style-type: none"> - The selected destination button lights up.  <ul style="list-style-type: none"> - The button with the destination channel indication is highlighted.  <ul style="list-style-type: none"> - Menu display appears as shown below. 
2	Press a source button to select source channel 8.	<ul style="list-style-type: none"> - The selected source button lights up.  <ul style="list-style-type: none"> - The button with the source channel indication is highlighted. 

- Destination and source channels can also be selected using **CONTROL** or the display. To select channels via **CONTROL**, the mode menu must be set to destination mode or source mode using the **MODE** button(s). (Supported for MFR-18RU/18RUA/39RU/39RUA/16RUTA/8RUA)
Operation using the display is available only on MFR-16RUD.
- MFR-18RU/18RUA/39RUA/16RUTA/8RUA units have the Control DestMode function, which can be set in the [Web-Based Control: RU Settings page]. If **Control DestMode** is set to **Crosspoint**, crosspoints can be switched by turning **CONTROL** after simultaneously pressing a destination button and **CONTROL**.
 - ▶ See Sec. 5-2-4. "Operating with CONTROL (Rotary Selector)" for details.
- Control Assist Buttons
The following functions are available using remote control unit buttons that assist crosspoint switches.
 - ▶ See Sec. 6-1-1-1 "SKIP-FWD/SKIP BWD" for SKIP-FWD and SKIP-BWD
 - ▶ See Sec. 6-1-1-2 "TENKEY" for -TENKEY

6-1-1-1. SKIP-FWD/BWD

The **SKIP-FWD** button allows you to skip current destination and source channel settings for a predetermined number. The **SKIP-BWD** button allows you to skip channels backward. In Destination mode, the destination number skips forward/backward for the predetermined number of steps. In Source mode, the source number skips forward/backward for the predetermined number of steps. In Level, Page or Setting mode, these buttons are disabled. (See Sec. 5-4-2. "Mode Menu.")

* To confirm the source selection, press **CONTROL**.

If source and/or destination channels are categorized, buttons allow you to go to the first or last channel in the category.

(Ex.) If Category 1: Dest 1 to 13, Category 2: Dest 14 to 20,
 SKIP-FWD is set to 5, and
 Current destination is 1.
 Pressing the **SKIP-FWD** button selects destination channels 1 → 6 → 11 → 13 → 14 → 19 → 20 → 21 → 26 → 31 → and so on.

Categories are user programmable source or destination channel groups. They are set under **Category** accessed from each Web-Based Control page.
 [Web-Based Control: **Router System Settings** > **Source Name** > **Category**]
 [Web-Based Control: **Router System Settings** > **Destination Name** > **Category**]

► See Sec. 5-4-3-2. "BTN ASSIGN" for details on how to assign these buttons.

6-1-1-2. TENKEY (MFR-39RU/39RUA)

The **TENKEY** button is used to enable Ten-key mode. Ten-key mode allows you to select source and destination channels using the Ten-key keypad that appears on the remote control unit. (Supported only in MFR-39RU/39RUA.)

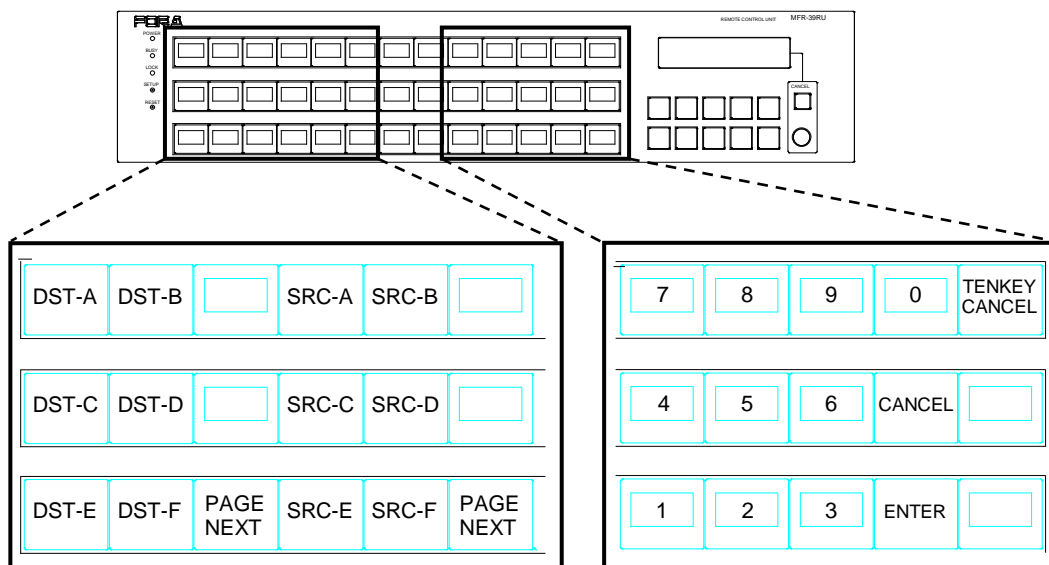

Category buttons

Ten-key keypad

Category buttons:	Selects a category from which to select a channel using the Ten-key keypad.
TENKEY CANCEL:	Exits TENKEY mode. The entered number is indicated on the button when "SETTING > TENKEY MOD (INPUT MODE)" is set to ENTER.
PAGE NEXT:	Moves to the next page for category buttons.
ENTER / CANCEL*:	Allows you to confirm or cancel the change when "SETTING > TENKEY MOD (INPUT MODE)" is set to ENTER. If it is set to DIRECT, entering a value changes and confirms the selection.
0 to 9 (TENKEY)*:	Selects a channel in the selected category. The TENKEY NO menu allows you to select whether to count from 0 or 1.

- * MFR-39RU: See "Setting Mode menu items table" on Sec. 5-4-3.
MFR-39RUA: See Sec. 5-4-4-9.

◆ Source channel selection using the Ten-key keypad function

If categories are set as; SRC-A (SRC 1 to 13), and SRC-B (SRC 14 to 20)

(Ex.1) TENKEY MOD (INPUT MODE) is **ENTER** and TENKEY NO (INPUT START NO) is **1**.
 - Select SRC-A, enter 3 on a Ten-key keypad and press ENTER to select SRC 3.
 - Select SRC-B, enter 5 on a Ten-key keypad and press ENTER to select SRC 18.

(Ex. 2) TENKEY MOD (INPUT MODE) is **DIRECT** and TENKEY NO (INPUT START NO) is **0**.
 - Select SRC-A, and enter 3 on a Ten-key keypad to select SRC 4.
 - Select SRC-B, and enter 0 on a Ten-key keypad to select SRC 14.

- ▶ See Sec. 5-4-3-2. "BTN ASSIGN" for details on how to assign the **TENKEY** button.

6-1-2. A Crosspoint Switching Using a Bus Button

A crosspoint button or a button to which a destination channel and source channel for the destination are assigned is called a bus button in a remote control unit. Bus buttons allow you to change a source channel to be output from a certain destination channel by one push of a button.

Bus button crosspoint switching can switch crosspoints regardless of the current destination selection.

- ▶ See Sec. 5-3. "Function Buttons" for details on button assignments.
 ▶ See Sec. 5-4-3-2. "BTN ASSIGN" and 5-5-2. "Changing Button Assignment" for details on how to assign bus buttons.

6-1-3. CHOP Function

The CHOP function allows you to alternate two images to compare the images.

◆ **Enabling the CHOP function**

1. Press one of two source buttons (source A) to compare the two.
2. While holding down one source button, press and release another source button (source B).

Source A and B images alternate.

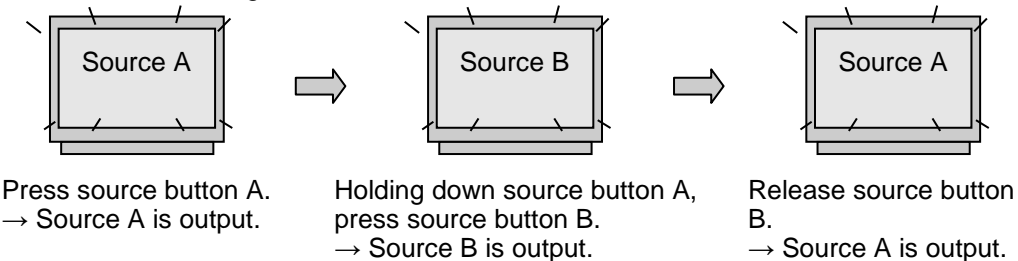

6-1-4. Crosspoint Switching Using TAKE Function

Crosspoint switching using the **TAKE** function is available by assigning **TAKE** to a remote control unit.

The **TAKE** function enables crosspoint switching when the **TAKE** button is pressed.

TAKE function has two modes. Respective remote control units can select either mode. To select a **TAKE** mode, select Preset or Direct under **TAKE** Mode in the [Web-Based Control: RU Settings page].

◆ **Preset mode**

Press the **TAKE** button to enable **TAKE**. Select crosspoints and press the **TAKE** button to switch crosspoints.

◆ **Direct mode**

The **TAKE** function is always enabled. Select crosspoints and press the **TAKE** button to switch crosspoints.

- Ex.1: To use the Preset mode TAKE button

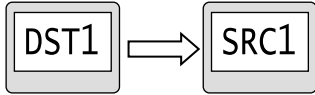
Step	Description
1	Press the TAKE button. Take function is enabled, and the button is highlighted. 
2	Select a crosspoint by selecting a destination and source buttons. The selected buttons will blink.  * To switch multiple crosspoints, repeat the procedure.
3	After completing the crosspoint selection, press the blinking TAKE button to switch the crosspoint/s. In multiple crosspoint switching, the last set of destination and source buttons are highlighted.

Once a crosspoint switch is complete, the **TAKE** button Preset mode is disabled. The button returns to Direct mode.
To switch crosspoints in the Preset mode again, repeat the procedure from step 1.

- Ex. 2: To use the Direct mode TAKE button

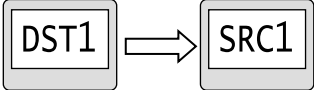
Step	Description
1	<p>In Direct mode, the Take function is always enabled.</p> <p>Select a crosspoint by selecting a destination and source buttons. The selected buttons blink.</p>  <p>* To switch multiple crosspoints, repeat the procedure.</p>
2	<p>After completing the crosspoint selection, press the blinking TAKE button to switch the crosspoint/s.</p> <p>In multiple crosspoint switching, the last set of destination and source buttons are highlighted.</p>

6-2. Simultaneous Crosspoint Switching

The simultaneous crosspoint switching function allows you to **simultaneously switch multiple crosspoints** by pressing a button. There are two ways to perform this switching. One is the **Salvo** function that switches by recalling the pre-assigned crosspoints. The other is the **Take** function that selects multiple crosspoints and switches them simultaneously.

SALVO crosspoints can be saved to either the routing switcher main unit (Main Unit Stored Salvo) or to the remote control unit (Remote Control Stored Salvo).

6-2-1. Main Unit Stored Salvos

This type of salvo allows you to store crosspoint data to be simultaneously switched into the routing switcher main unit. The stored data can be recalled from any connected remote control unit.

◆ Storing Salvo Data to Main Unit

Salvo data for Main Unit Stored Salvo can be stored using the Web-Based Control.

▶ See [Web-Based Control: **Salvo** page]

◆ Executing Salvos

Use a **SALVO** button (SALVO RECALL (MU)) on the remote control unit as shown in the procedure below.

1. Assign a **SALVO** button on the remote control unit. Set the salvo for **MU RECALL**, and select a Salvo number.
 - ▶ See Sec. 5-4-3-2. "BTN ASSIGN" and 5-5-2. "Changing Button Assignment"
2. Press the **SALVO** button to execute the salvo. The crosspoints stored to the salvo number are simultaneously switched.

6-2-2. Remote Control Stored Salvos

This type of salvo assigns crosspoints to be simultaneously switched to a button. Salvos can be recalled by the **SALVO** button on the remote control unit that assigned that SALVO. Once a salvo is executed, crosspoints assigned to the salvo are switched according to the current remote control level setting.

Remote Control Stored Salvo data can also be stored using the Web-Based Control.
▶ See [Web-Based Control: **Salvo** page]

◆ **Storing Salvo Data on a Remote Control Unit (MFR-39RU/39RUA only)**

Use a **SALVO** button on the remote control unit as shown in the procedure below.

1. Assign a **SALVO** button on the remote control unit. Set the salvo for **RU STORE**.
 - ▶ See Sec. 5-4-3-2. "BTN ASSIGN."
2. Store salvo data as shown in the table below.

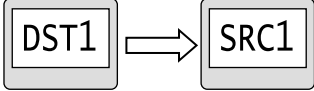
Step	Description
1	Press the SALVO button. The button is highlighted and ready for crosspoints to be assigned. 
2	To assign crosspoints to a salvo, press a destination button then a source button. The selected buttons flash.  Repeat the procedure for all crosspoints.
3	<p>MFR-39RU: After completing the crosspoint assignments, repress the SALVO button. The menu display appears as shown below.</p> <div style="border: 1px solid black; padding: 5px; margin: 10px auto; width: fit-content;"> SALVO STORE NO: 1 (NEW) <ENT> </div> <p>MFR-39RUA: After completing the crosspoints assignments, repress the SALVO button. The Current DEST and SRC button displays change as shown below.</p> <div style="display: flex; justify-content: center; gap: 20px;"> <div style="border: 1px solid black; padding: 5px; text-align: center;">STORE 1</div> <div style="border: 1px solid black; padding: 5px; text-align: center;">CANCEL</div> </div>
4	<p>MFR-39RU: To add crosspoints to an existing salvo, select a salvo number by turning CONTROL. Salvo numbers to which no crosspoints are assigned are indicated as NEW. Turn and press the CONTROL knob to confirm a number selection.</p> <p>MFR-39RUA: Turn, then press the CONTROL knob to confirm a number selection.</p>

◆ **Executing Salvos**

Use a **SALVO** button on the remote control unit as shown in the procedure below.

1. Assign a **SALVO** button on the remote control unit. Set the salvo for **RU RECALL**, and select a Salvo number.
 - ▶ See Sec. 5-4-3-2. "BTN ASSIGN" and 5-5-2. "Changing Button Assignment."
2. Press the **SALVO** button to execute the salvo. The crosspoints stored to the salvo number are simultaneously switched.

6-2-3. Simultaneous Switching Using the Take Function

The **TAKE** button on the remote control unit simultaneously switches preset crosspoints.

◆ Executing a TAKE

See Ex. 1) and Ex. 2) in Sec. 6-1-4. "Crosspoint Switching Using TAKE Function" for the procedure.

6-2-4. Simultaneous Switching by the Link Function

The **LINK** button on the remote control unit simultaneously switches crosspoints associated with a specific crosspoint.

Pressing the **LINK** button enables or disables the Link function. The **LINK** button is highlighted with a broad background when the function is enabled.

If the Link function is turned on, selecting a trigger crosspoint switches the slave crosspoints along with them.

▶ See [Web-Based Control: Link Settings page] for details.

6-3. Lock

Function setting/operation and crosspoint changes can be disabled by the Lock function.

◆ LOCK Function

The Lock function inhibits operation in the unit you are using or other units/groups than those of the group units being used. There are three types of Lock functions as shown in the chart below.

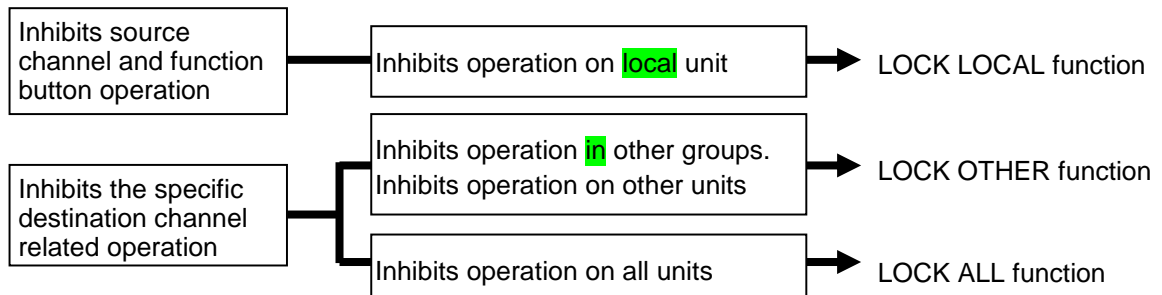

6-3-1. LOCK LOCAL

The Lock Local function inhibits button and menu operation that changes the source channel or sets or executes TAKE switching on the unit enabling the **LOCK** function. (Selecting destination channels is not inhibited.) This function is used to prevent operational mistakes.

◆ Enabling LOCK LOCAL

1. Assign **LOCK LOCAL** to a button on the remote control unit.
▶ See Sec. 5-4-3-2. "BTN ASSIGN" and 5-5-2. "Changing Button Assignment."
 2. Press the assigned **LOCK LOCAL** button to enable the Lock Local function.
- * Operations are locked for units in black boxes and not locked for units in white boxes.

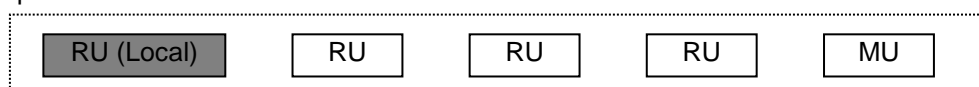

◆ **Disabling LOCK LOCAL**

Press the **LOCK LOCAL** button again.

If LOCK LOCAL is ON:

On the remote control unit:

- LOCK LED is lit green
- **LOCK LOCAL** is highlighted (text background illuminates.)
- Source and bus button indications are crossed out.

To check the **LOCK status**, press the current destination button.

The MENU display shows the LOCK status (ON or OFF) as shown below.

DST: 8 [DST8]
LK-LOCAL [PANEL LOCK]

DST: 8 [DST8]
LK-OFF [NOT LOCKED]

The **LOCK LOCAL** button and LOCK LED on the remote control unit flash if any inhibited operation such as changing the source channel is performed when Lock Local is enabled. (Only if the **LOCK LOCAL** button is assigned.)

LOCK LOCAL is enabled only in remote control units.

6-3-2. LOCK OTHER / LOCK ALL

The **LOCK OTHER** and **LOCK ALL** functions disable crosspoint switching for current destination channels to all other units (Lock Other) or all units (Lock All) including the unit that enabled the Lock function. Lock functions can be disabled only from the unit that enabled the function.*

* In multi-panel operation, lock functions can be disabled from any remote control unit in the operation system. Lock Other does not disable operation of remote control units in the system.

◆ **Enabling LOCK OTHER/LOCK ALL**

<Remote control unit settings>

1. Assign **LOCK OTHER** or **LOCK ALL** to a button on the remote control unit.
 - ▶ See Sec. 5-4-3-2. "BTN ASSIGN" and 5-5-2. "Changing Button Assignment."
2. Press the assigned button to enable the Lock function.

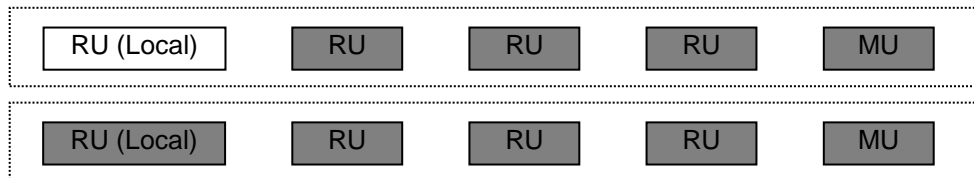

<Web-Based Control settings>

Open the [Web-Based Control: Lock Destination page], and assign a lock button.

◆ **Disabling LOCK OTHER/LOCK ALL**

Press the **LOCK OTHER** or **LOCK ALL** button again.

To disable LOCK OTHER or LOCK ALL from other units, press and hold the **LOCK** button for the time specified in the [Web-Based Control: **RU Settings** page].

If LOCK OTHER or LOCK ALL is ON:

On the remote control unit:

- LOCK LED illuminates
Orange: LOCK OTHER was enabled by itself.
Red: LOCK OTHER was enabled by other unit.
Red: LOCK ALL was enabled by any unit.
- The **LOCK** button is highlighted (background illuminates)
- LED and LCD colors of locked current destination buttons are changed to those set under **LockButtonColor** in the [Web-Based Control: **RU Settings** page] (MFR-40/ 18/ 39RU and 16RUTA)

To check the **LOCK** status, press the current destination button.

The MENU display shows the LOCK status and the ID number of the unit that has issued the LOCK command.

DST: 8 [DST8]
LK-ID: 103[OTHER PANELS]

LOCK OTHER ON

DST: 8 [DST8]
LK-ID: 103[ALL PANELS]

LOCK ALL ON

DST: 8 [DST8]
LK-OFF [NOT LOCKED]

LOCK OFF

The **LOCK** button and LOCK LED on the remote control unit flash if any inhibited operation such as selecting a source channel is performed when **Lock Other** (or **Lock All**) buttons are enabled and assigned.

◆ LOCK GROUP

The **LOCK OTHER** function also enables Group **LOCK OTHER**, which allows RU crosspoint switching only within the same group, and locks RU crosspoint switching in other groups. Any RU in the same group can lock or release the **LOCK OTHER** command. **LOCK ALL** disables crosspoint switching from all remote control units and can be unlocked only by remote control units in the same group.

<LOCK GROUP Setting Example>

This example creates the following three groups from five RU units as shown below using the Unit ID and Group ID numbers.

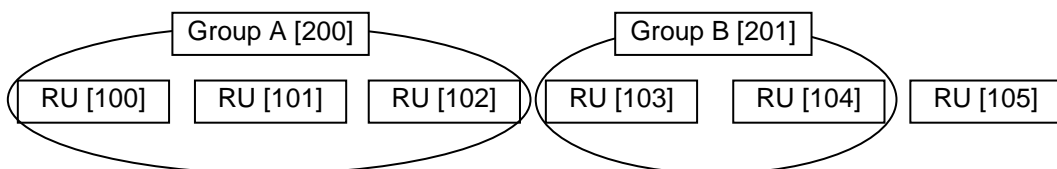

1. Open the [Web-Based Control: Lock Destination page]. Add RU [100], RU [101] and RU [102] to Group A.
2. Add RU [103] and RU [104] to Group B.

Once an RU is added to a group, the **LOCK OTHER/LOCK ALL** button on the RU changes to a **Group LOCK OTHER/LOCK ALL** button.

When **LOCK OTHER** is enabled by RU [100] - RU [103], RU [104] and RU [105] are locked. (Greyed out in the figure below.)



When LOCK OTHER is enabled by RU [103]...



When LOCK OTHER is enabled by RU [105]...

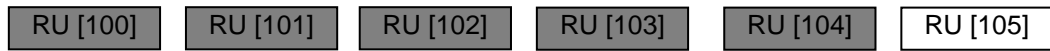

When sending **Group LOCK OTHER/LOCK ALL** commands, use a Group ID number in the [Web-Based Control :Lock Destination page].

If operating in Multi-panel mode, all linking remote control units must belong to the same group.

6-4. Monitor Output Function (MFR-5000/8000)

The monitor output function outputs the destination channel source through a **MONITOR OUT** port on the MFR-5000/8000 rear panel, allowing destination channels to be easily monitored.

◆ Enabling the Monitor Output Function

The **MONITOR OUT** function is disabled as default. To enable the function, use the Monitor Output button on the remote control unit.

▶ See 5-4-3-2. "BTN ASSIGN" and 5-5-2. "Button Assignment Change" for details on assigning button functions.

◆ Selecting Destinations to output from MONITOR OUT connectors

The following procedure shows how to use the monitor output function.

Step	Description
1	Press the assigned Monitor Out button on the remote control unit. The button is highlighted if the function is enabled.
2	Press a destination button to output destination channel signals from the Monitor Out port.

6-5. Preview Function

The preview function sets an output port on the Main Unit rear panel to be used for previews.

(Ex.) When pressing a source button on the remote control unit while simultaneously crosspoints switch, the selected source is output to the preview output, allowing source channel images to be checked before applying the Take function.

When a destination button is pressed, the source channel assigned for the destination channel is output to the preview output.

◆ Assigning Operation Preview to a Remote Control Unit Button

The Operation Preview function is disabled as default. To enable the function, assign the function to a remote control unit button in the Web-Based Control.

Only MFR-39RU and MFR-16RUD units can assign Operation Preview using front panel operation.

- ▶ See [Web-Based Control: **Assign Function** page].
- ▶ See Secs. 5-4-3-2. "BTN ASSIGN" and 5-5-2. "Changing Button Assignment."

◆ Outputting the Operation Preview

Press the **O-PREVIEW** button on the remote control unit to output the preview signal from the set destination channel.

7. Troubleshooting

If any of the following problems occur while operating your remote control unit, proceed as indicated below to see if the problem can be corrected before assuming a unit malfunction has occurred.

IMPORTANT

If the problem cannot be corrected by performing the procedures below, turn the unit power off, then on again. If the problem remains uncorrected, contact your FOR-A agent.

Problem	Check	Remedy
Unable to control using the remote control unit.	Is the LAN cable properly connected?	Properly re-connect the LAN cable.
	Is the RU Info page in the Web-Based Control indicating NG?	Check the item that is indicating an NG. If the Voltage is indicating an NG, contact your FOR-A agent.
The text color has changed from the original color.	That button displays may have deteriorated over time.	Refer to Sec. 7-1 to fine-tune colors.

7-1. Tuning the Text Color on Remote Unit Buttons

MFR-18RU/18RUA/39RU/39RUA/16RUTA/8RUA units allow you to adjust NAME DISPLAY and LCD colors.

7-1-1. MFR-18RU/39RU Color Tuning Procedure

Ex) MFR-18RU

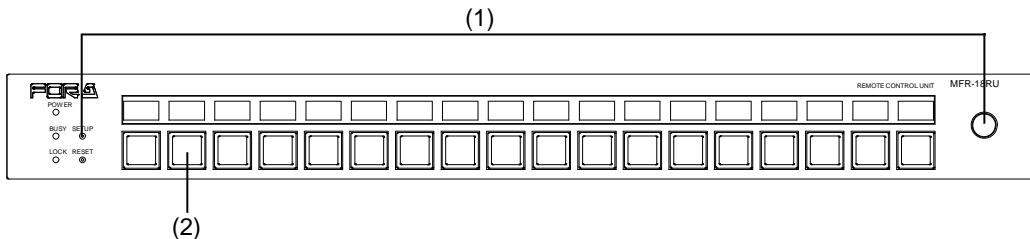

1. Press and hold **CONTROL**, then press the **SETUP** button for more than 5 seconds. All NAME DISPLAYs turn to white.
2. Press to adjust a button.

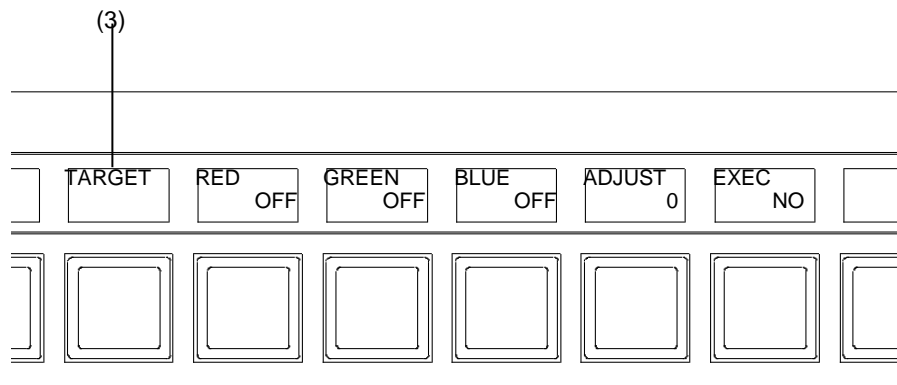

3. **TARGET** appears and blinks above the button, displaying **RED**, **GREEN**, **BLUE**, **ADJUST** and **EXEC**.
4. To set **RED**, **GREEN** or **BLUE** to **ON**, press **CONTROL** to select **RED**, **GREEN** or **BLUE**, then turn **CONTROL** to select the color to **ON**.
5. Press **CONTROL** to select **ADJUST**, then turn **CONTROL** to adjust the selected color component.
6. Press **CONTROL** to move to **EXEC**. Turn then press **CONTROL** to select **YES** and execute the setting.
8. **TARGET** will blink above the button.
Pressing another button allows you to apply the color setting to that button. **COPY** will appear above the button.
9. When all button color settings are finished, press **SETUP**.

7-1-2. MFR-39RUA/18RUA/16RUTA/8RUA Color Tuning Procedure

Ex) MFR-16RUTA

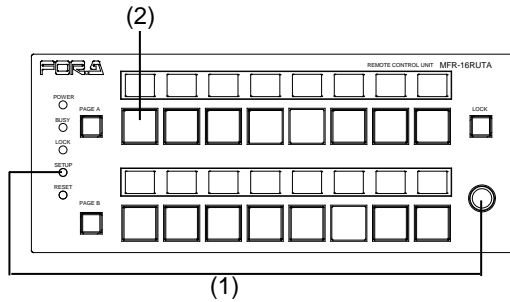

1. Press and hold **CONTROL** and press the **SETUP** button for more than 5 seconds. All NAME DISPLAYs turn to white.
2. Press to adjust a button.

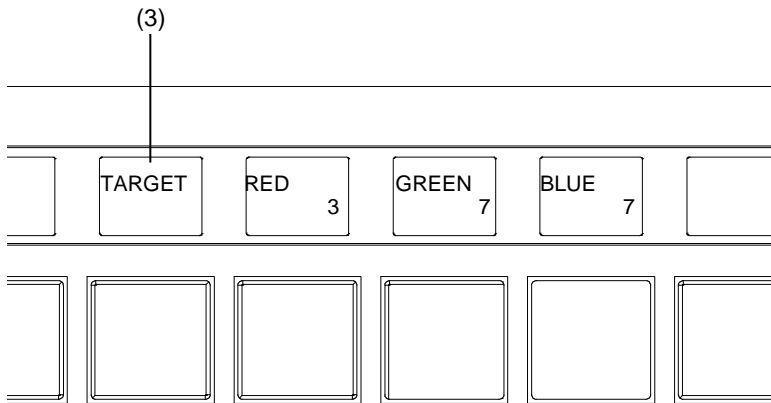

3. **TARGET** appears and blinks above the button, displaying **RED**, **GREEN** and **BLUE**.
4. To adjust the target button color using **RED**, **GREEN** and **BLUE**, press **CONTROL** to select **RED**, **GREEN** or **BLUE**, then turn **CONTROL** to change its value.
Setting range: RED: 0-3, GREEN and BLUE: 0-7
5. To adjust other button colors, repeat steps 2. through 4.
6. When all button color settings are finished, press **SETUP**.

8. Specifications and Dimensions

8-1. Unit Specifications

8-1-1. MFR-16RU/16RUD

Buttons/Color	16 buttons (1 color: Green), user assignable Menu Display (Max. 16 characters x 2 lines) (MFR-16RUD only)
Number of Connection	Max. 128 (including Main, Remote and GPI units)
Interfaces	
MFR-LAN	10/100BASE-TX RJ-45 x 1 (For connection to MU. A network hub required for multiple unit configuration.)
Temperature	0°C to 40°C
Humidity	30% to 85% (no condensation)
Power	+12 V DC Pin-connector x 1
Consumption	MFR-16RU: 100 V AC to 120 V AC: 7 VA (3 W), 200 V AC to 240 V AC: 11 VA (4 W) MFR-16RUD: 100 V AC to 120 V AC: 8 VA (3 W), 200 V AC to 240 V AC: 11 VA (4 W)
Dimensions	430(W) x 44(H) x 34 (D) mm EIA 1 RU
Weight	1 kg

8-1-2. MFR-40RU

Buttons/Colors	40 buttons (3 colors: Red/Green/Orange), user assignable
Number of Connections	Max. 128 units (including Main, Remote and GPI units)
Interfaces	
MFR-LAN	10/100BASE-TX RJ-45 x 1 (For connection to MU. A network hub required for multiple unit configuration.)
SERVICE	RS-232C 9-pin D-sub (male) x 1 (for maintenance)
Temperature	0°C to 40°C
Humidity	30% to 85% (no condensation)
Power	+12 VDC Pin-connector x 2 (redundant power supply as standard)
Consumption	100 V AC to 120 V AC: 10 VA (5 W), 200 V AC to 240 V AC: 15 VA (7 W)
Dimensions	430(W) x 44(H) x 42(D) mm EIA 1 RU
Weight	2 kg

8-1-3. MFR-16RUW

Buttons/Color	18 buttons (1 color: Green), user assignable
Number of Connection	Max. 128 (including Main, Remote and GPI units)
Interfaces	
MFR-LAN	10/100BASE-TX RJ-45 x 1 (For connection to MU. A network hub required for multiple unit configuration.)
Temperature	0°C to 40°C
Humidity	30% to 85% (no condensation)
Power	+12 VDC Pin-connector x 1
Consumption	100 V AC to 120 V AC: 8 VA (3 W), 200 V AC to 240 V AC: 11 VA (3 W)
Dimensions	480(W) x 44(H) x 27 (D) mm EIA 1 RU
Weight	1 kg

8-1-4. MFR-32RUW

Buttons/Color	34 buttons (1 color: Green), user assignable
Number of Connection	Max. 128 (including Main, Remote and GPI units)
Interfaces	
MFR-LAN	10/100BASE-TX RJ-45 x 1 (For connection to MU. A network hub required for multiple unit configuration.)
Temperature	0°C to 40°C
Humidity	30% to 85% (no condensation)
Power	+12 VDC Pin-connector x 1
Consumption	100 V AC to 120 V AC: 10 VA (4 W), 200 V AC to 240 V AC: 13 VA (4 W)
Dimensions	480(W) x 44(H) x 27 (D) mm EIA 1 RU
Weight	1 kg

8-1-5. MFR-64RUW

Buttons/Color	64 buttons (1 color: Green), user assignable
Number of Connection	Max. 128 (including Main, Remote and GPI units)
Interfaces	
MFR-LAN	10/100BASE-TX RJ-45 x 1 (For connection to MU. A network hub required for multiple unit configuration.)
Temperature	0°C to 40°C
Humidity	30% to 85% (no condensation)
Power	+12 VDC Pin-connector x 1
Consumption	100 V AC to 120 V AC: 15 VA (7 W) 200 V AC to 240 V AC: 20 VA (8 W)
Dimensions	480(W) x 88(H) x 27(D) mm EIA2RU
Weight	1.5 kg

8-1-6. MFR-18RU

Buttons/Colors	18 buttons (3 colors: Red/Green/Orange), user assignable LCD display x 18 (Max. 7 characters x 2 lines, Displayed above each button) with Rotary selector
Number of Connection	Max. 128 (including Main, Remote and GPI units)
Interfaces	
MFR-LAN	10/100BASE-TX RJ-45 x 1 (For connection to MU. A network hub required for multiple unit configuration.)
SERVICE	RS-232C 9-pin D-sub (male) x 1 (for maintenance)
Temperature	0°C to 40°C
Humidity	30% to 85% (no condensation)
Power	+12 V DC Pin-connector x 2 (redundant power supply as standard)
Consumption	100 V AC to 120 V AC: 12 VA (6 W), 200 V AC to 240 V AC: 18 VA (8 W)
Dimensions	430(W) x 44(H) x 42(D) mm EIA 1 RU
Weight	2 kg

8-1-7. MFR-18RUA

Buttons/Colors	18 buttons (3 colors: Red/Green/Orange), user assignable OLED display x 18 (Max. 7 characters x 2 lines, Displayed above each button) with Rotary selector
Number of Connection	Max. 128 (including Main, Remote and GPI units)
Interfaces	
MFR-LAN	10/100BASE-TX RJ-45 x 1 (For connection to MU. A network hub required for multiple unit configuration.)
SERVICE	RS-232C 9-pin D-sub (male) x 1 (for maintenance)
Temperature	0°C to 40°C
Humidity	30% to 85% (no condensation)
Power	+12 V DC Pin-connector x 2 (redundant power supply as standard)
Consumption	100 V AC to 120 V AC: 14 VA (6 W), 200 V AC to 240 V AC: 18 VA (6 W)
Dimensions	430(W) x 44(H) x 42(D) mm EIA 1 RU
Weight	2 kg

8-1-8. MFR-39RU

Buttons/Colors	39 buttons (LED buttons, 7-color) Displayed in each button (Max. 7 characters x 2 lines) 10 buttons (3 colors: Red/Green/Orange), user assignable Menu display x 1 (Max. 23 characters x 2 lines) with Rotary selector
Number of Connections	Max. 128 (including Main, Remote and GPI units)
Interfaces	
MFR-LAN	10/100BASE-TX RJ-45 x 1 (For connection to MU. A network hub required for multiple unit configuration.)
SERVICE	RS-232C 9-pin D-sub (male) x 1 (for maintenance)
Temperature	0°C to 40°C
Humidity	30% to 85% (no condensation)
Power	+12 V DC Pin-connector x 2 (redundant power supply as standard)
Consumption	100 V AC to 120 V AC: 17 VA (9 W), 200 V AC to 240 V AC: 22 VA (11 W)
Dimensions	430(W) x 88(H) x 44(D) mm EIA 2 RU
Weight	3 kg

8-1-9. MFR-39RUA

Buttons/Colors	39 buttons (OLED buttons, 7-color) Displayed in each button (Max. 7 characters x 2 lines) 6 buttons (3 colors: Red/Green/Orange), user assignable Current DEST button, current SRC button, current PAGE display x 2, Rotary selector
Number of Connections	Max. 128 (including Main, Remote and GPI units)
Interfaces	
MFR-LAN	10/100BASE-TX RJ-45 x 1 (For connection to MU. A network hub required for multiple unit configuration.)
SERVICE	RS-232C 9-pin D-sub (male) x 1 (for maintenance)
Temperature	0°C to 40°C
Humidity	30% to 85% (no condensation)
Power	+12 V DC Pin-connector x 2 (redundant power supply as standard)
Consumption	100 V AC to 120 V AC: 19 VA (9 W), 200 V AC to 240 V AC: 24 VA (9 W)
Dimensions	430(W) x 88(H) x 42(D) mm EIA 2 RU
Weight	3 kg

8-1-10. MFR-16RUTA

Buttons/Color	16 buttons (3 colors: Red/Green/Orange), user assignable OLED display x 16 (Max. 7 characters x 2 lines, 7-color, Displayed above each button) 2 buttons for PAGE control (lit orange) 1 button for LOCK control (lit orange) Rotary selector
Number of Connection	Max. 128 (including Main, Remote and GPI units)
Interfaces	
MFR-LAN	10/100BASE-TX RJ-45 x 1 (For connection to MU. A network hub required for multiple unit configuration.)
Temperature	0°C to 40°C
Humidity	30% to 85% (no condensation)
Power	+12 V DC Pin-connector x 1
Consumption	100 V AC to 120 V AC: 12VA (5W) 200 V AC to 240 V AC: 15VA (6W)
Dimensions	215(W) x 88(H) x 43(D) mm EIA 2 RU, half-rack size
Weight	1 kg

8-1-11. MFR-8RUA

Buttons/Colors	8 buttons (3 colors: Red/Green/Orange), user assignable OLED display x 8 (Max. 7 characters x 2 lines, 7-color, Displayed above each button) with Rotary selector
Number of Connection	Max. 128 (including Main, Remote and GPI units)
Interfaces	
MFR-LAN	10/100BASE-TX RJ-45 x 1 (For connection to MU. A network hub required for multiple unit configuration.)
SERVICE	RS-232C 9-pin D-sub (male) x 1 (for maintenance)
Temperature	0°C to 40°C
Humidity	30% to 85% (no condensation)
Power	+12 V DC Pin-connector x 2 (redundant power supply as standard)
Consumption	100 V AC to 120 V AC: 9VA (3W) 200 V AC to 240 V AC: 11VA (3W)
Dimensions	212(W) x 44(H) x 42(D) mm EIA1RU half size
Weight	1 kg

8-2. External Dimensions

8-2-1. MFR-16RU

(All dimensions in mm.)

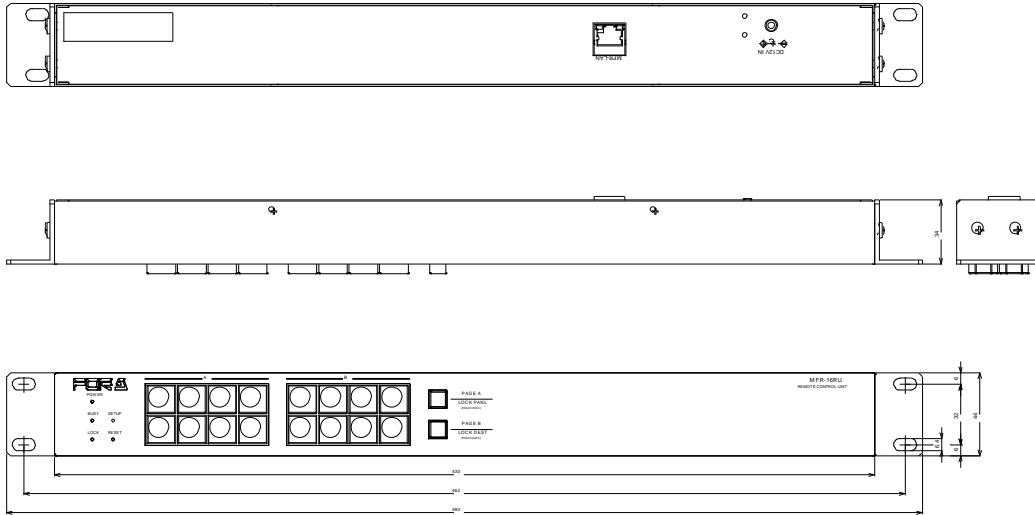

8-2-2. MFR-40RU

(All dimensions in mm.)

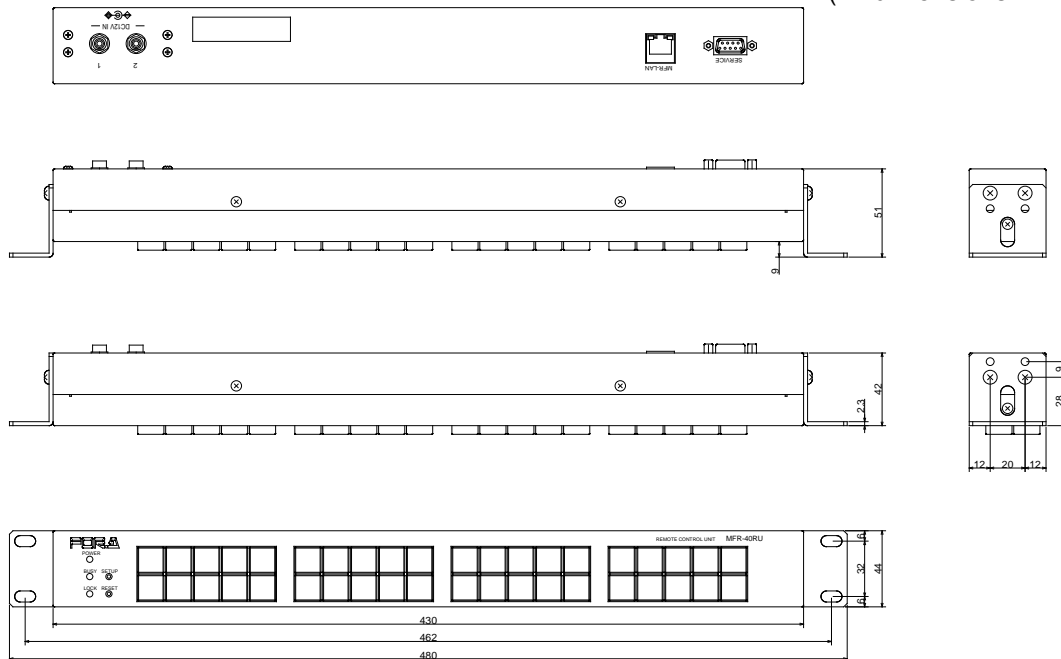

* The panel buttons can be fitted within the rack by sliding the rack ears forward to attach as shown in the bottom figure above.

8-2-3. MFR-16RUD

(All dimensions in mm.)

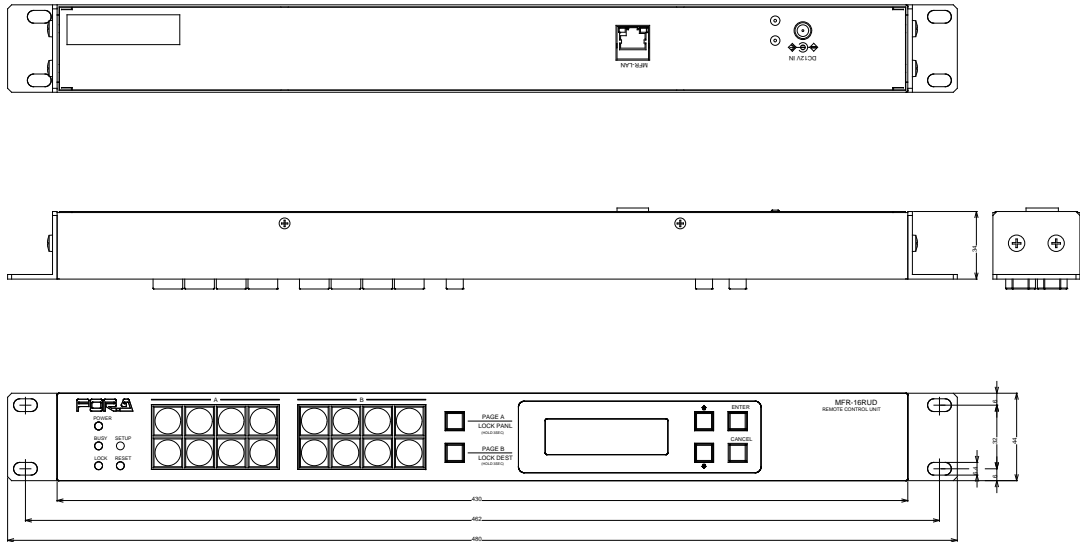

8-2-4. MFR-16RUW

(All dimensions in mm.)

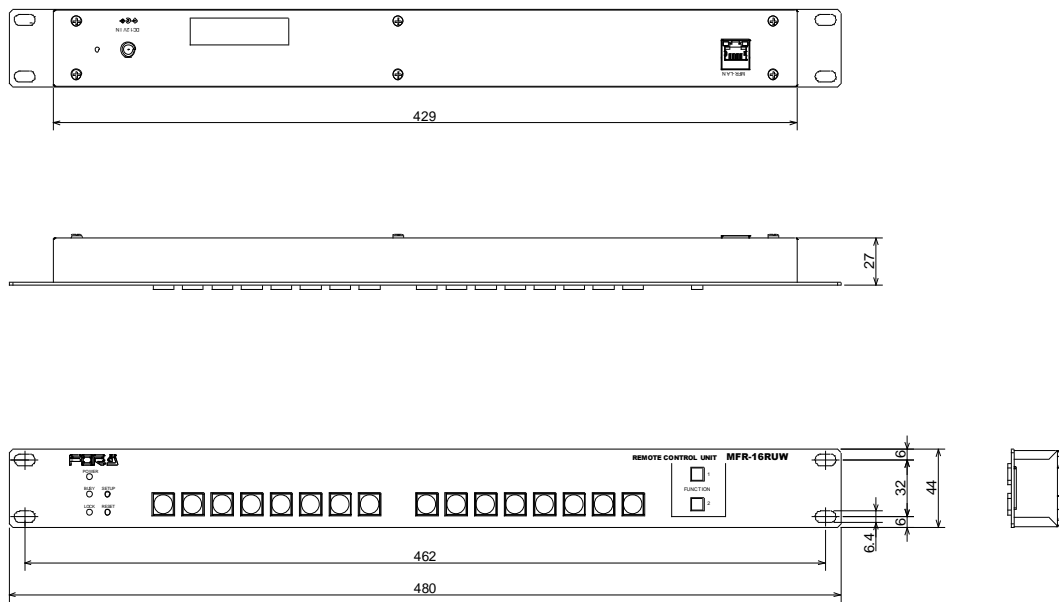

8-2-5. MFR-32RUW

(All dimensions in mm.)

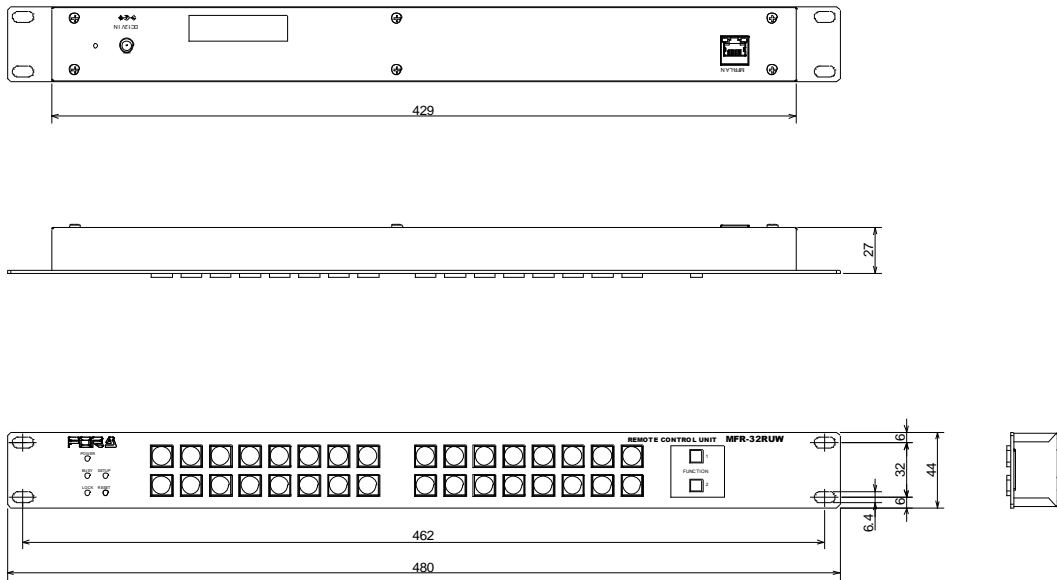

8-2-6. MFR-64RUW

(All dimensions in mm.)

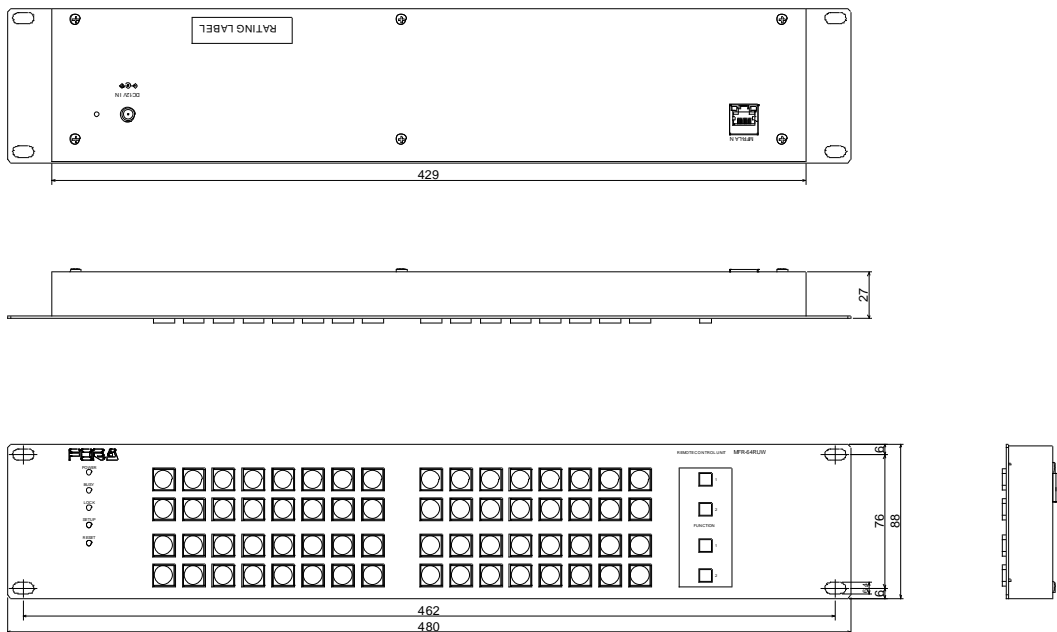

8-2-7. MFR-18RU

(All dimensions in mm.)

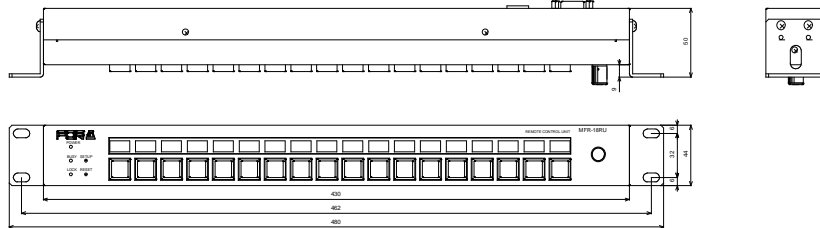
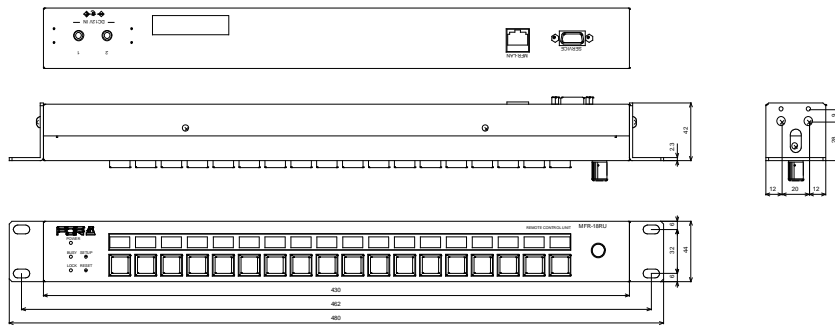

- * The panel buttons can be fitted within the rack by sliding the rack ears forward to attach as shown in the bottom figure above.

8-2-8. MFR-18RUA

(All dimensions in mm.)

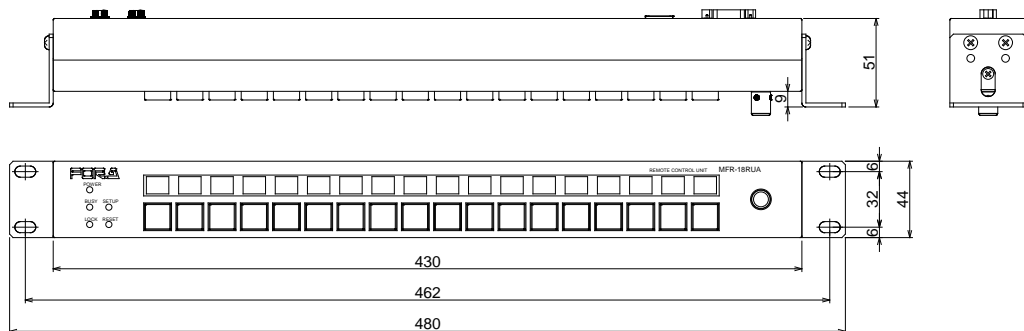
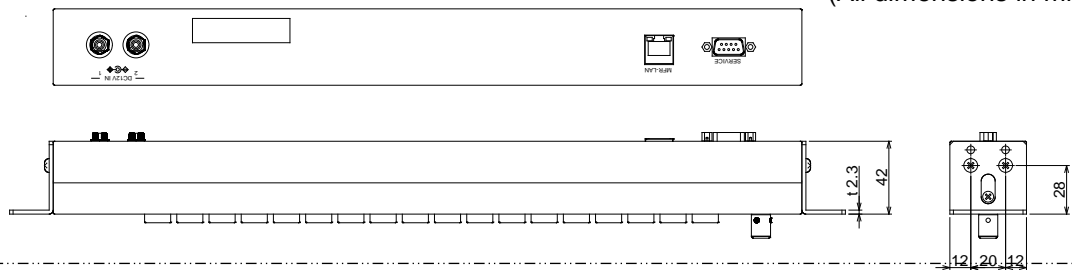

- * The panel buttons can be fitted within the rack by sliding the rack ears forward to attach as shown in the bottom figure above.

8-2-9. MFR-39RU

(All dimensions in mm.)

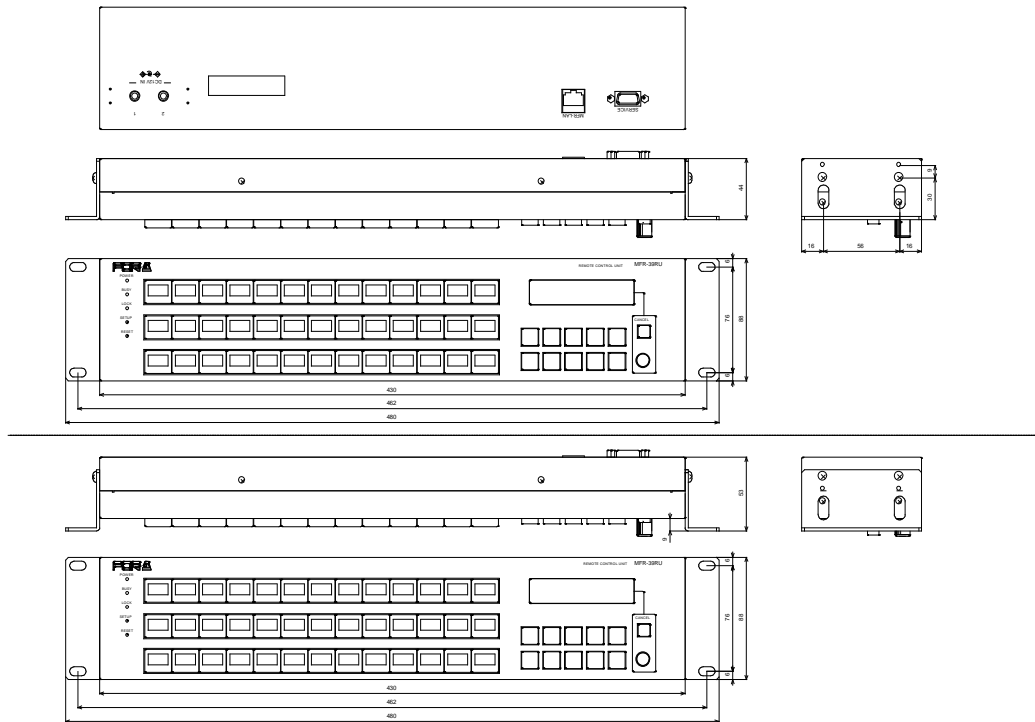

- * The panel buttons can be fitted within the rack by sliding the rack ears forward to attach as shown in the bottom figure above.

8-2-10. MFR-39RUA

(All dimensions in mm.)

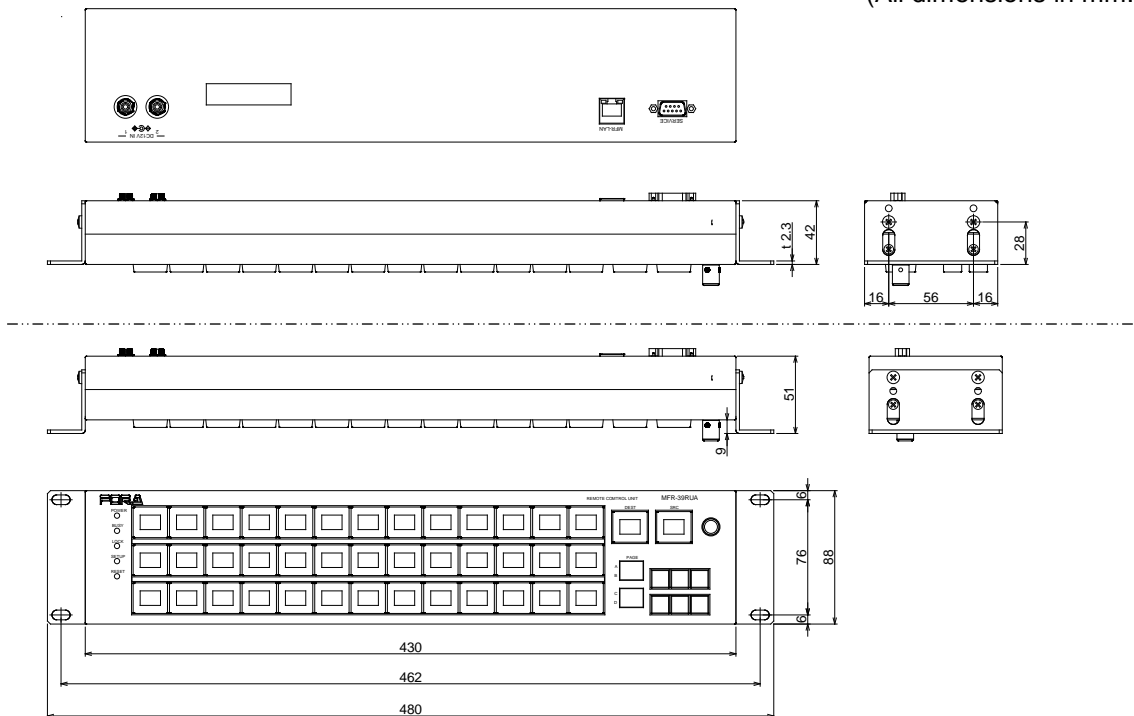

- * The panel buttons can be fitted within the rack by sliding the rack ears forward to attach as shown in the bottom figure above.

8-2-11. MFR-16RUTA

(All dimensions in mm.)

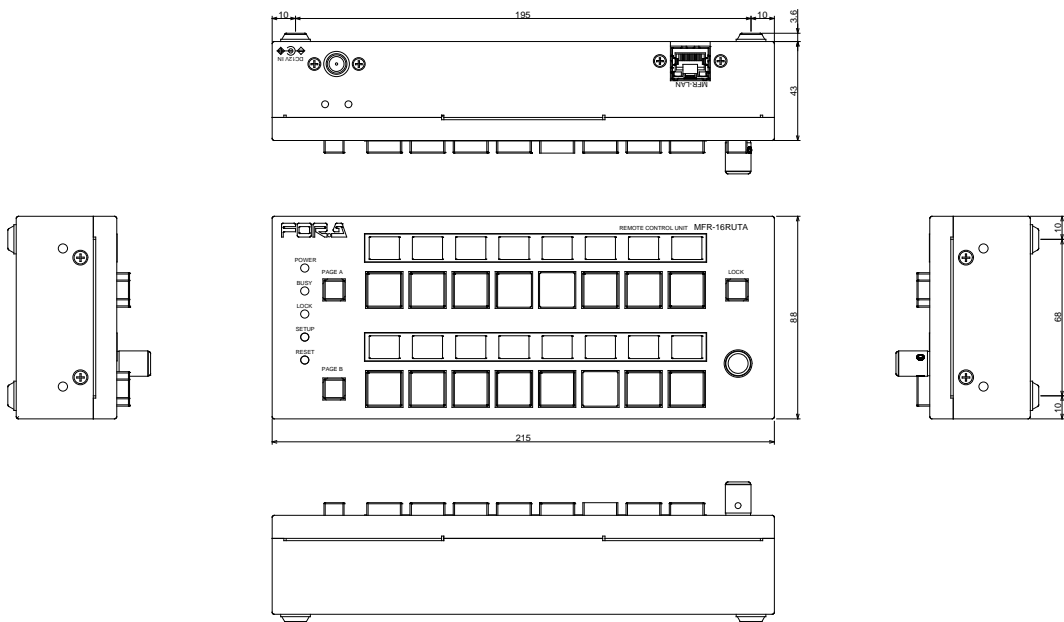

8-2-12. MFR-8RUA

(All dimensions in mm.)

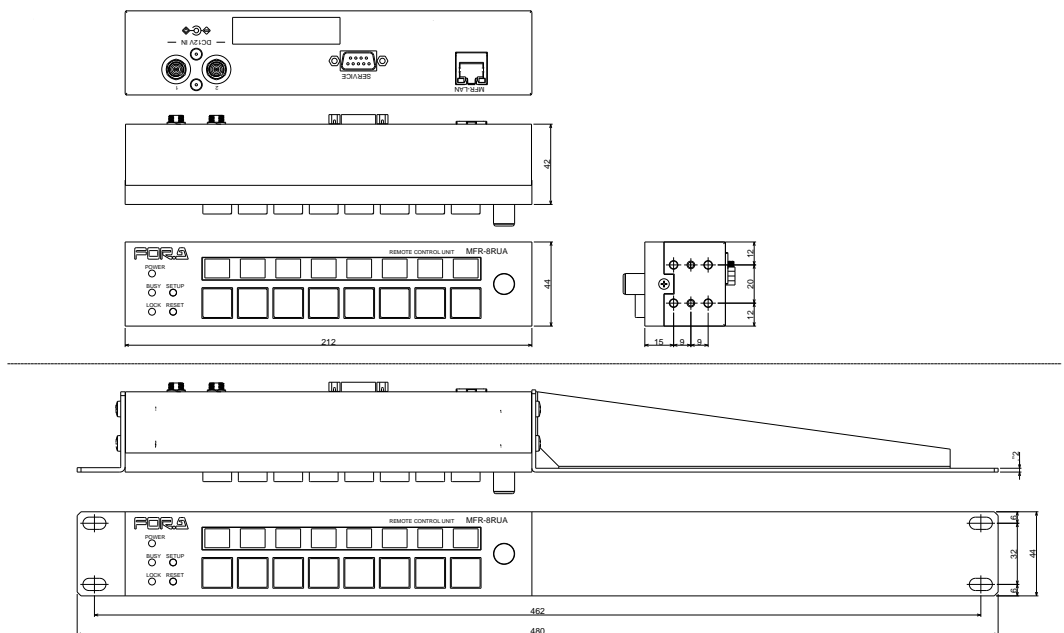

Appendix: Operation Tips

How to use Page buttons

Page buttons can be assigned to front panel buttons on remote control units.

- ▶ See Sec. 5-2-2. “Switching Pages” and Sec. 5-3. “Function Buttons.”
- ▶ See [Web-Based Control: RU Settings > **Assign Function**].

◆ Page Up/Page Down buttons

These buttons allow you to move one page forward/backward.

Ex) Assign “Page Up” for Group B to Button 9 in the Web GUI

1. Click **System Settings** in the left pane.
2. Click to select [(RU name)-**Assign Function**] in the left pane to display the setting page.
3. Select **9** under [Button ID].
4. Select **Page** under [Function].
5. Select **UP** under [Up/Down] and **B** under [Group].
6. Click **Send** to apply settings.

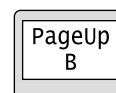

◆ Page Jump buttons

Pressing the button jumps to the specified page. Pressing again jumps to the next specified page.

Ex) Assign Page Jump between 3 and 7 for Group B, C and D to Button 1 in the Web GUI

1. Click to select [(RU name)-**Assign Function**] in the left pane to display the setting page.
2. Select **1** under [Button ID].
3. Select **Page** under [Function].
4. Select **Jump** under [Up/Down] and enable B, C and D under [Group], then select **3** under [Fwd] and **7** under [Rev].
5. Click **Send** to apply settings.

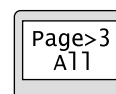

If **HOME** is set for [Rev], pressing the button returns to the previous page before jumping to page 3. If current page is Page 3 (Fwd setting), the button is highlighted.

The MFR-16RUD/39RU/39RUA units allow you to assign functions to buttons by front panel operation.

- ▶ For default page buttons on the RU front panel, see Sec. 3-1. “Front Panel.”
- ▶ For MFR-16RUD units, see Sec. 5-5-2. “Changing Button Assignment.”
- ▶ For MFR-39RU units, see “PAGE MODE” and “PAGE ASSIGN.” on the Table “**Setting Mode menu items**” in Sec. 5-4-3-2. “BTN ASSIGN.”
- ▶ For MFR-39RUA units, see Sec. 5-4-4-4. “BUTTON ASSIGN” and 5-4-4-10. “PAGE.”