



OXYGEN 1000 & OXYGEN 2000

(Rev. 6.2.0.2 - ENG)

SUMMARY

SUMMARY	2
SAFETY WARNINGS/ISTRUZIONI PER LA SICUREZZA	5
PREFACE.....	5
SAFETY WARNINGS	6
CONSIGNES DE SÉCURITÉ IMPORTANTES	8
ISTRUZIONI IMPORTANTI PER LA SICUREZZA	10
WICHTIGE SICHERHEITSHINWEISE	13
INSTRUCCIONES IMPORTANTES DE SEGURIDAD	15
UNPACKING AND INSPECTION	17
FIRST INSTALLATION RECOMMENDATIONS	18
POWER SUPPLY CABLE.....	18
PROTECTION AGAINST LIGHTNING.....	18
OXYGEN 1000 & OXYGEN+ 2000 INSTALLATION NOTE AND FIRST STEP.....	19
BEST SETUP LOCATION	19
INTRODUCTION	20
1. GENERAL DESCRIPTION.....	21
1.1 OXYGEN 1000 DIMENSIONS	21
1.2 OXYGEN 2000 DIMENSIONS	22
1.3 TALKBOX DIMENSIONS	23
1.4 INPUT CONNECTIONS	24
1.5 OUTPUT CONNECTIONS.....	26
1.6 COMMUNICATION CONNECTIONS	27
1.7 TALKBOX CONNECTIONS	28
2. FIRST CONSOLE IP ADDRESS ASSIGNMENT	29
3. SURFACE	32
3.1 CHANNEL CONTROLS	34
3.2 OUTPUT LEDMETERS	44
3.3 MONITORS SECTION	45
3.4 BLUETOOTH BUTTON	57
4. OXYGEN REMOTER - SETTINGS	59
4.1 OXYGEN REMOTER SIDE – ON BUTTON.....	59
4.2 SPECIAL OXYGEN REMOTER FUNCTION BUTTONS.....	61
4.3 MONITORS SECTION	66
4.4 AUDIO	74
4.4.1.1 MIC/MONO.....	74
4.4.1.1.1 MIC (GENERAL)	75
4.4.1.1.2 MIC (EQ).....	84
4.4.1.1.3 MIC (COMPRESSOR).....	86
4.4.1.1.4 MIC (DUCKING).....	87
4.4.1.2.1 MONO (GENERAL)	90
4.4.1.2.2 MONO (EQ).....	99
4.4.1.2.3 MONO (COMPRESSOR).....	102
4.4.1.2.4 MONO (DUCKING)	103
4.4.2.1 STEREO.....	106
4.4.2.1.1 STEREO (GENERAL)	107

4.4.2.1.2	STEREO (EQ).....	113
4.4.2.1.3	STEREO (COMPRESSOR).....	115
4.4.2.1.4	STEREO (DUCKING).....	116
4.4.3.1	TEL/BT.....	119
4.4.3.1.1	TELCO 1 / TELCO 2 / TELCO 3 / TELCO 4 / TELCO 5 (GENERAL).....	119
4.4.3.1.2	TELCO 1 / TELCO 2 / TELCO 3 / TELCO 4 / TELCO 5 (DEVICE).....	127
4.4.3.1.3	TELCO 1 / TELCO 2 / TELCO 3 / TELCO 4 / TELCO 5 (EQ).....	127
4.4.3.1.4	TELCO 1 / TELCO 2 / TELCO 3 / TELCO 4 / TELCO 5 (DUCKING).....	130
4.4.3.1.5	TELCO 1 – GPIO MANAGEMENT.....	133
4.4.3.1.6	TELCO 2 / TELCO 3 / TELCO 4 / TELCO 5 ACTIVATION.....	134
4.4.3.2.1	TELEPHONE (GENERAL).....	135
4.4.3.2.2	TELEPHONE (EQ).....	142
4.4.3.2.3	TELEPHONE (DUCKING).....	144
4.4.3.3.1	BLUETOOTH PAIRING.....	147
4.4.3.3.2	BLUETOOTH (GENERAL).....	148
4.4.3.3.3	BLUETOOTH (EQ).....	155
4.4.3.3.4	BLUETOOTH (DUCKING).....	157
4.4.4.1	DIGITAL.....	160
4.4.4.1.1	USB1 / USB 2 (GENERAL).....	161
4.4.4.1.2	USB1 / USB2 (EQ).....	167
4.4.4.1.3	USB1 / USB2 (DUCKING).....	169
4.4.4.2.1	DANTE 1 / DANTE 2 / DANTE 3 / DANTE 4 / DANTE 5 / DANTE 6 / DANTE 7 / DANTE 8 (GENERAL)....	171
4.4.4.2.2	DANTE 1 / DANTE 2 / DANTE 3 / DANTE 4 / DANTE 5 / DANTE 6 / DANTE 7 / DANTE 8 (EQ).....	178
4.4.4.2.3	DANTE 1 / DANTE 2 / DANTE 3 / DANTE 4 / DANTE 5 / DANTE 6 / DANTE 7 / DANTE 8 (DUCKING)....	180
4.4.5.1	TONE GEN.	182
4.4.5.1.1	TONE GEN. (GENERAL).....	182
4.4.5.1.2	TONE GEN. (EQ).....	186
4.4.5.1.3	TONE GEN. (DUCKING).....	186
4.5.1.1	ANALOG.....	187
4.5.1.1.1	OUT-1 (PROGRAM).....	187
4.5.1.1.2	OUT-2.....	189
4.5.1.1.3	OUT-3.....	190
4.5.1.1.4	OUT-4.....	191
4.5.1.2	DIGITAL.....	192
4.5.1.2.1	AESEBU-OUT (ON THE “DIGITAL OUT” CONNECTOR).....	193
4.5.1.2.2	USB 1 / USB 2.....	194
4.5.1.2.3	DANTE-OUT-1 / DANTE-OUT-2 / DANTE-OUT-3 / DANTE-OUT-4 / DANTE-OUT-5 / DANTE-OUT-6 / DANTE-OUT-7-PGM / DANTE-OUT-8-SUB /.....	195
4.5.1.3	MONITOR.....	196
A.	SPEAKER.....	196
I.	SPK-CRM.....	197
II.	SPK-STUDIO.....	202
B.	HEADPHONES.....	207
I.	HDP-CRM.....	208
II.	HDP-STUDIO.....	209
4.7.1.1	GENERAL / INPUT MODE.....	212
A.	EXT. INPUT.....	212
B.	PFL MODE.....	213
C.	FADER REMOTE CONTROL MODE.....	214
D.	ENABLE VIRTUAL CHANNELS.....	215
E.	A/B SWITCH.....	215
F.	FADER THRESHOLD.....	217

G.	LINE1 MODE	217
H.	LINE2 MODE	217
I.	LINE3 MODE	218
J.	DANTE 1 MODE (IF THE CONSOLE HAS "DANTE OPTION").....	218
4.7.1.2	VJ PRO MODE	219
4.8	GENERAL	220
4.8.1.2	GPI.....	227
4.8.1.3	GPO.....	228
4.8.2.2	TCP-IP.....	230
4.8.2.3	TIME&DATE	231
4.8.2.4	ACCESS CODE	233
4.8.2.5	LIGHT&DISPLAY	234
4.9	SERVICE.....	238
4.9.1.1	SAVE YOUR CONFIGURATION.....	239
4.9.1.2	RESTORE YOUR CONFIGURATION.....	239
4.9.1.3	EXECUTE A FACTORY RESET.....	241
4.9.1.4	LOGO CUSTOMIZATION	241
4.9.1.5	FIRMWARE.....	242
4.9.1.6	SOFTWARE.....	243
4.9.1.7	LOGS.....	245
4.9.1.8	WEB LOGIN	246
4.10	SMART KEY / JINGLE BUTTONS*	247
4.11	SNAPSHOTS.....	259
5	USB AUDIO 1 AND USB AUDIO 2 - AUDIO CARDS.....	262
6	DANTE – IP AUDIO STREAMS	263
7	TELEPHONE LINES USAGE AND CONNECTIONS	268
7.3	INTEGRATED HYBRID LINE	268
7.4	EXTERNAL TELCO DEVICE.....	269
7.4.2.1	ADDITIONAL TELCO INPUT LINES.....	271
7.4.2.2	ADDITIONAL TELCO OUTPUT LINES (CLIENFIELD / N-1 LOGIC).....	272
7.4.2.3	USABLE GPIO FOR THE ADDITIONAL TELCO LINES.....	273
7.5	EXTERNAL BLUETOOTH DEVICE	275
8	ADDITIONAL VIRTUAL CHANNELS	276
9	HDMI OUTPUT	278
9.3	HDMI OUTPUT – NORMAL MODE	278
9.4	HDMI MENU NAVIGATION – SPECIAL MODE	279
10	SUBD9-GPIO	284
11	+ 187 – OXY1000-OXY2000-RJ45-MIC.....	285
12	+ 188 – OXY1000-OXY2000-RJ45-TELCO	286
13	+ 189 – OXY1000-OXY2000-RJ45-LINE-IN	287
14	+ 190 – OXY1000-OXY2000-RJ45-LINE-OUT	288
15	TECH SPECS.....	289
	WEEE DIRECTIVE – INFORMATIVA RAE	293
	WARRANTY	294
	OXYGEN 1000 - DECLARATION OF CONFORMITY.....	295
	OXYGEN 1000 - DICHIARAZIONE DI CONFORMITA'.....	296

SAFETY WARNINGS/ISTRUZIONI PER LA SICUREZZA

SAFETY WARNINGS

CONSIGNES DE SÉCURITÉ IMPORTANTES

ISTRUZIONI IMPORTANTI PER LA SICUREZZA

WICHTIGE SICHERHEITSHINWEISE

INSTRUCCIONES IMPORTANTES DE SEGURIDAD

(Rel. 6.2.0.2)

PREFACE

For your safety and to prevent the warranty from being accidentally invalidated, please read carefully all the texts marked with the Warning Symbols



The information contained in this manual is subject to change without notice and does not constitute a commitment by the seller.

The manufacturer will not be liable for any loss or damage resulting from the use of information or any errors contained in this manual or resulting from any erroneous operation or hardware failure contained in the product.

It is recommended that any repair and maintenance of the product be carried out by the manufacturer or its authorized agents. The manufacturer assumes no responsibility for any loss or damage caused by service, maintenance, or repair by unauthorized personnel.

SAFETY WARNINGS

The installation and servicing instructions in this manual are for use by qualified personnel only.

Read All Instructions. All safety and operating instructions must be read before operating the product. They also must be retained for future reference, as it contains many useful hints for determining the best combination of equipment settings for Yr particular application.

Heed All Warnings. All warnings on the product and those listed in the operating instructions must be adhered to.

Heat. This product must be situated away from any heat sources such as radiators or other products (including power amplifiers or transmitters) that produce heat.

Power Sources. This product must be operated from the type of power source indicated on the marking label and in the installation instructions. If you are not sure of the type of power supplied to your facility, consult your local power company. Make sure the AC main voltage corresponds to that indicated in the technical specifications. If a different voltage (ex. 110/115 VAC) is available, open the equipment closure and set the voltage switch on the main supply circuit, located behind the AC socket.

Power Cord Protection. Power supply cords must be routed so that they are not likely to be walked on or pinched by items placed upon or against them. Pay particular attention to the cords at AC wall plugs and convenience receptacles, and at the point where the cord plugs into the product.

Use only with a cart, stand, tripod, bracket, or table specified by the manufacturer, or sold with the apparatus. When a cart is used, use caution when moving the cart/apparatus combination to avoid injury from tip-over.

Lightning. For added protection for this product during a lightning storm, or when it is left unattended and unused for long periods, unplug it from the AC wall outlet and the audio connections. This will prevent damage to the product due to lightning and power-line surges.

Installation. Configuration and installation should only be carried out by a competent installation engineer.

Cabling. Using high-quality wires, well-protected. Make sure the cable integrity.



This symbol alerts you to the presence of dangerous voltage inside the closure – voltage that may be sufficient to constitute a risk of shock. Do not perform any servicing other than that contained in the operating instructions. Refer all servicing to qualified personnel.



The exclamation point within an equilateral triangle is intended to alert the user to the presence of important operating and maintenance (servicing) instructions in the literature accompanying the appliance.



Do not change the voltage setting or replace the mains fuse without first turning the unit off and unplugging the mains cord.



Make sure the AC main voltage corresponds to that indicated in the technical specifications.

THIS APPARATUS MUST BE EARTHED!



To avoid the risk of fire, use the correct value fuse, as indicated on the label stuck on the right side of the unit.



This apparatus uses a single-pole main switch and does therefore not separate the unit completely from the mains power. To completely separate from mains power (f.i. in the event of danger) unplug the mains power cord. As the MAINS plug is the disconnect device, the disconnect device shall remain readily operable.

CONSIGNES DE SÉCURITÉ IMPORTANTES

Lire ces consignes.

Conserver ces consignes.

Observer tous les avertissements.

Suivre toutes les consignes.

Ne pas utiliser cet appareil à proximité de l'eau.

Ne pas obstruer les ouvertures de ventilation. Installer en respectant les consignes du fabricant.

Ne pas installer à proximité d'une source de chaleur telle qu'un radiateur, une bouche de chaleur, un poêle ou d'autres appareils (dont les amplificateurs) produisant de la chaleur.

Ne pas annuler la sécurité de la fiche de terre, la troisième branche est destinée à la sécurité. Si la fiche fournie ne s'adapte pas à la prise électrique, demander à un électricien de remplacer la prise hors normes.

Protéger le cordon d'alimentation afin que personne ne marche dessus et que rien ne le pince, en particulier aux fiches, aux prises de courant et au point de sortie de l'appareil.

Utiliser uniquement les accessoires spécifiés par le fabricant.

Utiliser uniquement avec un chariot, un support ou une table spécifié par le fabricant ou vendu avec l'appareil. Si un chariot est utilisé, déplacer l'ensemble chariot–appareil avec précaution afin de ne pas le renverser, ce qui pourrait entraîner des blessures.

Débrancher l'appareil pendant les orages ou quand il ne sera pas utilisé pendant longtemps.

Confier toute réparation à du personnel qualifié. Des réparations sont nécessaires si l'appareil est endommagé d'une façon quelconque, par exemple: cordon ou prise d'alimentation endommagé, liquide renversé ou objet tombé à l'intérieur de l'appareil, exposition de l'appareil à la pluie ou à l'humidité, appareil qui ne marche pas normalement ou que l'on a fait tomber.

NE PAS exposer cet appareil aux égouttures et aux éclaboussures. Ne pas poser des objets contenant de l'eau, comme des vases, sur l'appareil.



Ce symbole indique la présence d'une tension dangereuse dans l'appareil constituant un risque de choc électrique.



Ce symbole indique que la documentation fournie avec l'appareil contient des instructions d'utilisation et d'entretien importantes.



Avant de modifier le commutateur de changement de tension ou replacer le fusible il faut débrancher l'appareil de la prise électrique. Pendant son usage, l'appareil doit être branché à la prise de terre.



Utiliser le fusible principal AC avec la valeur qui est indiquée sur l'étiquette collée sur le coffret.



Assurez-vous que la tension principale AC correspond à celle indiquée dans les spécifications techniques.



L'interrupteur d'alimentation interrompt un pôle du réseau d'alimentation excepté le conducteur de terre de protection. En cas de danger, débrancher le cordon d'alimentation. Parce que la prise du réseau de alimentation est utilisée comme dispositif de déconnexion, ce dispositif doit demeurer aisément accessible.

ISTRUZIONI IMPORTANTI PER LA SICUREZZA

Leggere le presenti istruzioni.

Conservare queste istruzioni.

Osservare tutte le avvertenze.

Seguire scrupolosamente tutte le istruzioni.

Non usare questo apparecchio in prossimità di acqua.

Non ostruire alcuna apertura per il raffreddamento. Installare l'apparecchio seguendo le istruzioni.

Non installare l'apparecchio accanto a fonti di calore quali radiatori, aperture per l'afflusso di aria calda, forni o altri apparecchi (amplificatori inclusi) che generino calore.

Non rimuovere il terminale di connessione a terra sul cordone di alimentazione: esso ha lo scopo di tutelare l'incolumità dell'utilizzatore. Se la spina in dotazione non si adatta alla presa di corrente, rivolgersi ad un elettricista per far eseguire le modifiche necessarie.

Evitare di calpestare il cavo di alimentazione o di comprimerlo, specialmente in corrispondenza della spina e del punto di inserzione sull'apparato.

Utilizzare solo dispositivi di collegamento e gli accessori specificati dal produttore.

Utilizzare l'apparecchio solo con un carrello, un sostegno, una staffa o un tavolo di tipo specificato dal produttore o venduto insieme all'apparecchio. Se si utilizza un carrello, fare attenzione negli spostamenti per evitare infortuni causati da ribaltamenti del carrello stesso.

Scollegare l'apparecchio dalla presa di corrente durante i temporali o quando inutilizzato a lungo.

Per qualsiasi intervento, rivolgersi a personale di assistenza qualificato. È necessario intervenire sull'apparecchio ogniqualvolta si verificano danneggiamenti di qualsiasi natura. Ad esempio, la spina o il cavo di alimentazione sono danneggiati, è entrato liquido nell'apparecchio o sono caduti oggetti su di esso, l'apparecchio è stato esposto alla pioggia o all'umidità, non funziona normalmente o è caduto.

Non esporre a sgocciolamenti o spruzzi. Non appoggiare sull'apparecchio oggetti pieni di liquidi, ad esempio vasi da fiori.

Il prodotto deve essere connesso ad impianti costruiti secondo la regola dell'arte e muniti di protezione differenziale del circuito con valore non superiore agli 0,03A.

Tenere il prodotto lontano da liquidi.

Il prodotto deve essere utilizzato solo se integro e non danneggiato. Se il prodotto è stato sottoposto a forti urti o fosse venuto a contatto con liquidi è necessario contattare l'assistenza prima di accenderelo.

Il prodotto non va aperto per nessun motivo, non va modificato o manomesso. E' vietato tentare qualsiasi tipo di riparazione.

E' obbligatorio leggere il manuale utente prima di utilizzare il prodotto.

Il prodotto deve essere utilizzato da persone adulte. Tenere il prodotto fuori dalla portata dei bambini

Il prodotto va collegato ad impianti costruiti secondo la regola dell'arte e muniti di protezioni magnetotermiche del circuito.

E' proibito sovraccaricare le prese di corrente. E' obbligatorio spegnere il prodotto se non utilizzato.

E' proibito ostruire le aperture di raffreddamento e aerazione.

E' obbligatorio tenere materiali infiammabili/combustibili lontani dal prodotto.

E' vietato utilizzare il prodotto in presenza di sostanze che possano creare atmosfera esplosiva.

Il prodotto va utilizzato posizionato e utilizzato in maniera stabile.



Questo simbolo indica la presenza di alta tensione all'interno dell'apparecchio, che comporta rischi di scossa elettrica.



Questo simbolo indica la presenza di istruzioni importanti per l'uso e la manutenzione nella documentazione in dotazione all'apparecchio.



Non sostituire il fusibile o cambiare la tensione di alimentazione senza aver prima scollegato il cordone di alimentazione. **L'APPARATO DEVE ESSERE CONNESSO A TERRA.**



Sostituire il fusibile generale con uno di identico valore, come indicato sulla etichetta applicata sul mobile dell'apparato



Assicurarsi che la tensione di rete corrisponda a quella per la quale è configurato l'apparecchio.



Questo apparato utilizza un interruttore di alimentazione di tipo unipolare e l'isolamento dalla rete elettrica non è pertanto completo. Per ottenere un isolamento totale (ad esempio in caso di pericolo), scollegare il cordone di alimentazione. Inoltre, poichè la spina di alimentazione è utilizzata come dispositivo di sezionamento, essa deve restare facilmente raggiungibile.

WICHTIGE SICHERHEITSHINWEISE

Diese Hinweise LESEN.

Diese Hinweise AUFHEBEN.

Alle Warnhinweise BEACHTEN.

Alle Anweisungen BEFOLGEN.

Dieses Gerät NICHT in der Nähe von Wasser verwenden.

KEINE Lüftungsöffnungen verdecken. Gemäß den Anweisungen des Herstellers einbauen.

Nicht in der Nähe von Wärmequellen, wie Heizkörpern, Raumheizungen, Herden oder anderen Geräten (einschließlich Verstärkern) installieren, die Wärme erzeugen.

Die Schutzfunktion des Schukosteckers NICHT umgehen. Bei Steckern für die USA gibt es polarisierte Stecker, bei denen ein Leiter breiter als der andere ist; US-Stecker mit Erdung verfügen über einen dritten Schutzleiter. Bei diesen Steckerausführungen dient der breitere Leiter bzw. der Schutzleiter Ihrer Sicherheit. Wenn der mitgelieferte Stecker nicht in die Steckdose passt, einen Elektriker mit dem Austauschen der veralteten Steckdose beauftragen.

VERHINDERN, dass das Netzkabel gequetscht oder darauf getreten wird, insbesondere im Bereich der Stecker, Netzsteckdosen und an der Austrittsstelle vom Gerät.

NUR das vom Hersteller angegebene Zubehör und entsprechende Zusatzgeräte verwenden.

NUR in Verbindung mit einem vom Hersteller angegebenen oder mit dem Gerät verkauften Transportwagen, Stand, Stativ, Träger oder Tisch verwenden. Wenn ein Transportwagen verwendet wird, beim Verschieben der Transportwagen-Geräte- Einheit vorsichtig vorgehen, um Verletzungen durch Umkippen.

Das Netzkabel dieses Geräts während Gewittern oder bei längeren Stillstandszeiten aus der Steckdose ABZIEHEN.

Alle Reparatur- und Wartungsarbeiten von qualifiziertem Kundendienstpersonal DURCHFÜHREN LASSEN. Kundendienst ist erforderlich, wenn das Gerät auf irgendeine Weise beschädigt wurde, z.B. wenn das Netzkabel oder der Netzstecker beschädigt wurden, wenn Flüssigkeiten in das Gerät verschüttet wurden oder Fremdkörper hineinfließen, wenn das Gerät Regen oder Feuchtigkeit ausgesetzt war, nicht normal funktioniert oder fallen gelassen wurde.

Dieses Gerät vor Tropf- und Spritzwasser SCHÜTZEN. KEINE mit Wasser gefüllten Gegenstände wie zum Beispiel Vasen auf das Gerät STELLEN.



Dieses Symbol zeigt an, dass gefährliche Spannungswerte, die ein Stromschlagrisiko darstellen, innerhalb dieses Geräts auftreten.



Dieses Symbol zeigt an, dass das diesem Gerät beiliegende Handbuch wichtige Betriebs- und Wartungsanweisungen enthält.



Vor Änderung der Netzspannung oder Sicherungswechsel Netzkabel trennen.
Das Gerät muss für den Betrieb geerdet werden.



Vor Änderung der Netzspannung oder Sicherungswechsel Netzkabel trennen.
Das Gerät muss für den Betrieb geerdet werden.



Hauptsicherung nur mit einer gleichwertigen austauschen
(s. entsprechende Etikette).



Vor Einschalten Netzspannungseinstellung am Gerät überprüfen bzw. anpassen.



Inpoliger Netzschalter. In Notfälle oder für Wartungsarbeiten Netzkabel trennen. Der Netzstecker fungiert auch als Trennelement muss deshalb zugänglich bleiben.

INSTRUCCIONES IMPORTANTES DE SEGURIDAD

LEA estas instrucciones.

CONSERVE estas instrucciones.

PRESTE ATENCION a todas las advertencias.

SIGA todas las instrucciones.

NO utilice este aparato cerca del agua.

NO obstruya ninguna de las aberturas de ventilación. Instálese según lo indicado en las instrucciones del fabricante.

No instale el aparato cerca de fuentes de calor tales como radiadores, registros de calefacción, estufas u otros aparatos (incluyendo amplificadores) que produzcan calor.

NO anule la función de seguridad del enchufe polarizado o con clavija de puesta a tierra. Un enchufe polarizado tiene dos patas, una más ancha que la otra. Un enchufe con puesta a tierra tiene dos patas y una tercera clavija con puesta a tierra. La pata más ancha o la tercera clavija se proporciona para su seguridad. Si el toma corriente no es del tipo apropiado para el enchufe, consulte a un electricista para que sustituya el toma corriente de estilo anticuado.

PROTEJA el cable eléctrico para evitar que personas lo pisen o estrujen, particularmente en sus enchufes, en los toma corrientes y en el punto en el cual sale del aparato.

UTILICE únicamente los accesorios especificados por el fabricante.

UTILICESE únicamente con un carro, pedestal, escuadra o mesa del tipo especificado por el fabricante o vendido con el aparato. Si se usa un carro, el mismo debe moverse con sumo cuidado para evitar que se vuelque con el aparato.

DESENCHUFE el aparato durante las tormentas eléctricas, o si no va a ser utilizado por un lapso prolongado.

TODA reparación debe ser llevada a cabo por técnicos calificados. El aparato requiere reparación si ha sufrido cualquier tipo de daño, incluyendo los daños al cordón o enchufe eléctrico, si se derrama líquido sobre el aparato o si caen objetos en su interior, si ha sido expuesto a la lluvia o la humedad, si no funciona de modo normal, o si se ha caído.

NO exponga este aparato a chorros o salpicaduras de líquidos. **NO** coloque objetos llenos con líquido, tales como floreros, sobre el aparato .



Este símbolo indica que la unidad contiene niveles de voltaje peligrosos que representan un riesgo de choques eléctricos.



Este símbolo indica que la literatura que acompaña a esta unidad contiene instrucciones importantes de funcionamiento y mantenimiento.



Antes de cambiar la alimentación de voltaje o de cambiar el fusible, desconecte el cable de alimentación. Para reducir el riesgo de descargas eléctricas, esta unidad debe ser conectada a tierra.



Reemplace el fusible con lo mismo, que corresponde a lo indicado en el panel del equipo.



Antes de encender, controlar que la línea de alimentación de voltaje corresponda a la indicada.



El interruptor de alimentación es unipolar. En el caso de peligro, desconecte el cable de alimentación. Porque la clavija de conexión a red sirve por la desconexión de la unidad, la clavija debe ser ubicada en proximidad de la unidad.

UNPACKING AND INSPECTION

Your equipment was packed carefully at the factory in a container designed to protect the unit during shipment. Nevertheless, we recommend making a careful inspection of the shipping carton and the contents for any signs of physical damage.

Damage & Claims

If the damage is evident, do not discard the container or packing material. Contact your carrier immediately to file a claim for damages. Customarily, the carrier requires you, the consignee, to make all damage claims. It will be helpful to retain the shipping documents and the waybill number.

Save all packing materials! If You should ever have to ship the unit (e.g. for servicing), it is best to ship it in the original carton with its packing materials because both the carton and packing material have been carefully designed to protect the unit.

Under normal conditions, no user maintenance or calibration is required. Internal links and preset controls may be set to configure the unit during installation. Any service work required should be carried out by qualified service personnel only.

We can offer further product support through our worldwide network of approved dealers and service agents.

To help us provide the most efficient service please would you keep a record of the unit serial number and date and place of purchase to be quoted in any communication regarding this product.

The actual equipment Serial Number is indicated on the silver label stuck on the rear panel of the equipment closure.



Tools and Equipment Needed

Only standard technician tools are required to install this equipment.

FIRST INSTALLATION RECOMMENDATIONS

POWER SUPPLY CABLE

A power supply cable of approx. 2 mt. lengths is supplied with the device, which has a moulded IEC plug attached – this is a legal requirement.

The type of plug for the power supply depends on the country in which it is delivered.

If for any reason, you need to use this appliance with a different plug, you should use the following wiring guidelines in replacing the existing plug with the new one:

Earth	Green, or green and yellow
Neutral (N)	Blue
Live (L)	Brown

Supply cables should be laid in such a manner that one does not step or walk on them. They should not be squashed by any objects.

THIS EQUIPMENT MUST BE EARTHED.

The chassis is always connected to mains earth to ensure your safety: check your mains wiring and earthing before switching on.

PROTECTION AGAINST LIGHTNING



Should the device be put out of action due to being struck by lightning or excess voltage, disconnect it from the power supply without delay. Do not reconnect until the device has been checked. If in doubt contact the technical support service.

Make sure there is suitable lightning protection to protect the device. Alternatively, you should disconnect all connectors from the device during a storm or when the device is going to be unsupervised or not used for a longer period.

These measures will protect against damage by lightning or excess voltage.

OXYGEN 1000 & OXYGEN+ 2000 INSTALLATION NOTE AND FIRST STEP

Best setup location

Oxygen 1000 & Oxygen 2000 should be installed avoiding direct sunlight, close proximity to radiators and air conditioning, dust, water, and chemicals. Choose a console location that permits a clear view of the indicators on the device and ensures a sufficient heat dissipation of the device.

Power supply

The device is designed for operation with 100 to 240 VAC, 50 Hz to 60 Hz. Check the corresponding device labelling for compatibility with the domestic line voltage and frequency before connecting the IEC power connector to the mains supply!



WARNING

Disconnect the mains power plug before you open the housing. Repair of the equipment must only be carried out by authorized and qualified personnel.

Power Supply	Please make sure that the device and the contained fuse(s) (please see p. 17) are compatible with the domestic line voltage and frequency. If the device is compatible, connect the power supply cord fully to the IEC power connector at the rear side of the device and a mains power outlet. The “LCD Screen” will then turn on.
Network configuration	OXYGEN has a display, so you can configure the IP settings directly: See step “LAN-1 PAGE FUNCTIONALITY (HOW TO SET THE TCP/IP ETH-1)”
Connect to network	Connect a network patch cable to the “10/100-Base-T” connector on the rear side of the device and your existing IP network.
Ready!	These first steps are only intended for a quick first start and do not cover all device functions. Please read carefully the entire manual to be able to use all functions of the device.

INTRODUCTION

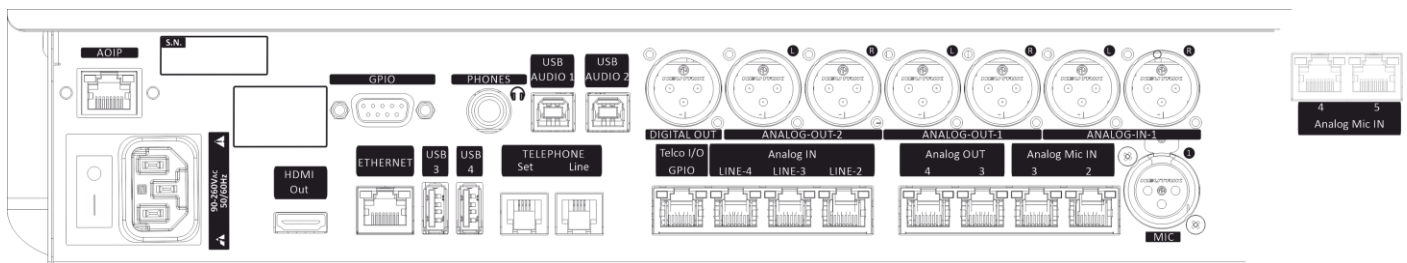

- Oxygen 1000 & Oxygen 2000 are the new concept digital console and follow the new Oxygen 3000 standard in the broadcast market.
- Characterized by an elegant design and compact size, Oxygen 1000 & Oxygen 2000 have been designed for both On-Air and Production studios.
- Oxygen 1000 & Oxygen 2000 are based on digital technology with DSP audio processing to deliver high-end quality, latest features, and flexibility with ease of use.
- Oxygen 1000 & Oxygen 2000 are the top models in the category at the best quality/price ratio.
- Oxygen 1000 is a powerful and compact unit featuring 6 faders, a wide range of connectivity, and accessories in a rugged and classy steel chassis. Easy and reliable as the analog mixing consoles.
- Oxygen 2000 is a powerful and compact unit featuring 12 faders, a wide range of connectivity, and accessories in a rugged and classy steel chassis. Easy and reliable as the analog mixing consoles.
- Oxygen 1000 & Oxygen 2000 add the value of the digital engine that grants a near 0 latency ($< 0,7$ ms I/O) and plenty of advanced functions as the internal routing signal, customizable pre-set and easy recall, user-defined smart keys, analog, and digital I/O.
- Oxygen 1000 & Oxygen 2000 are provided with a web server compatible with all browsers and devices, which allows the user to remotely control all console settings.
- Oxygen 1000 and Oxygen 2000 have an HDMI port that allows you to connect screens, to give an intuitive display of the console's operation, through an elegant and wide graphics on a black background suitable for all the world-wide radio studios.

1. GENERAL DESCRIPTION

1.1 OXYGEN 1000 DIMENSIONS

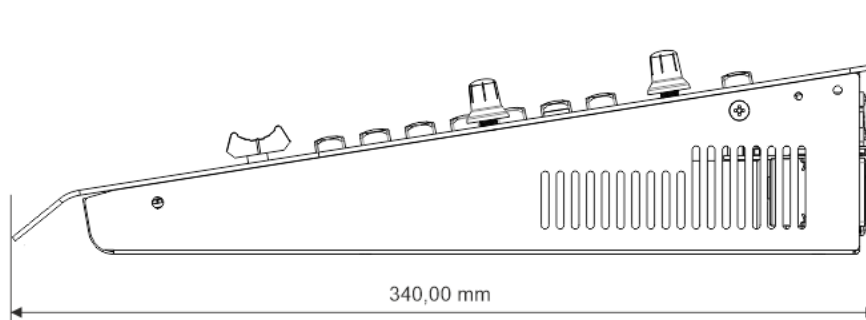
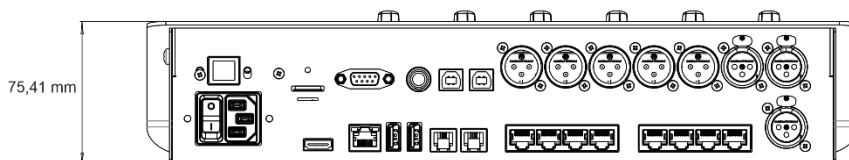
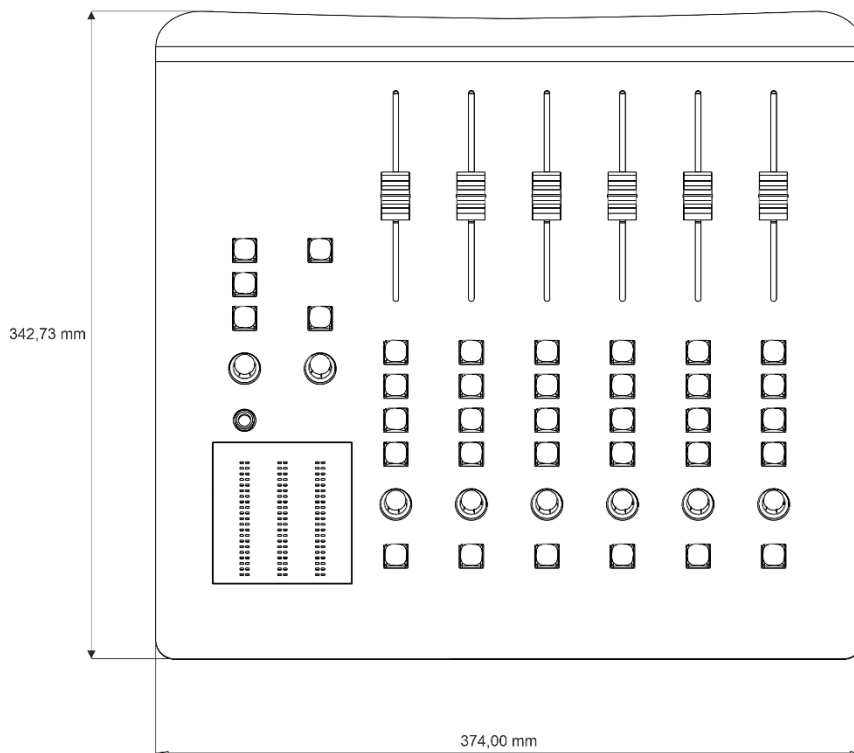

1.2 OXYGEN 2000 DIMENSIONS

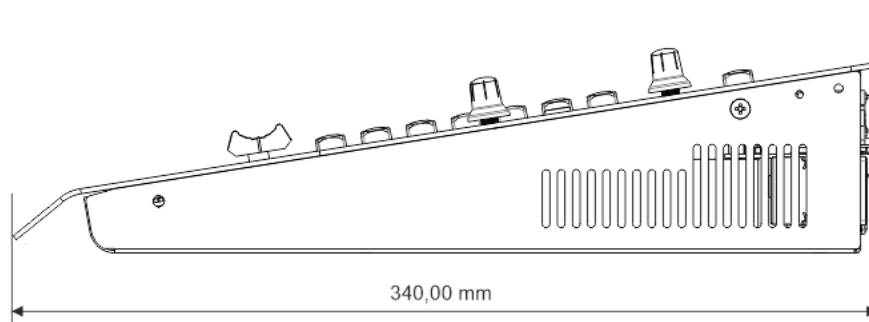
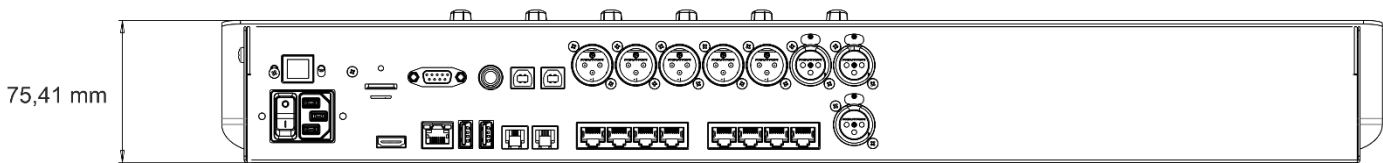
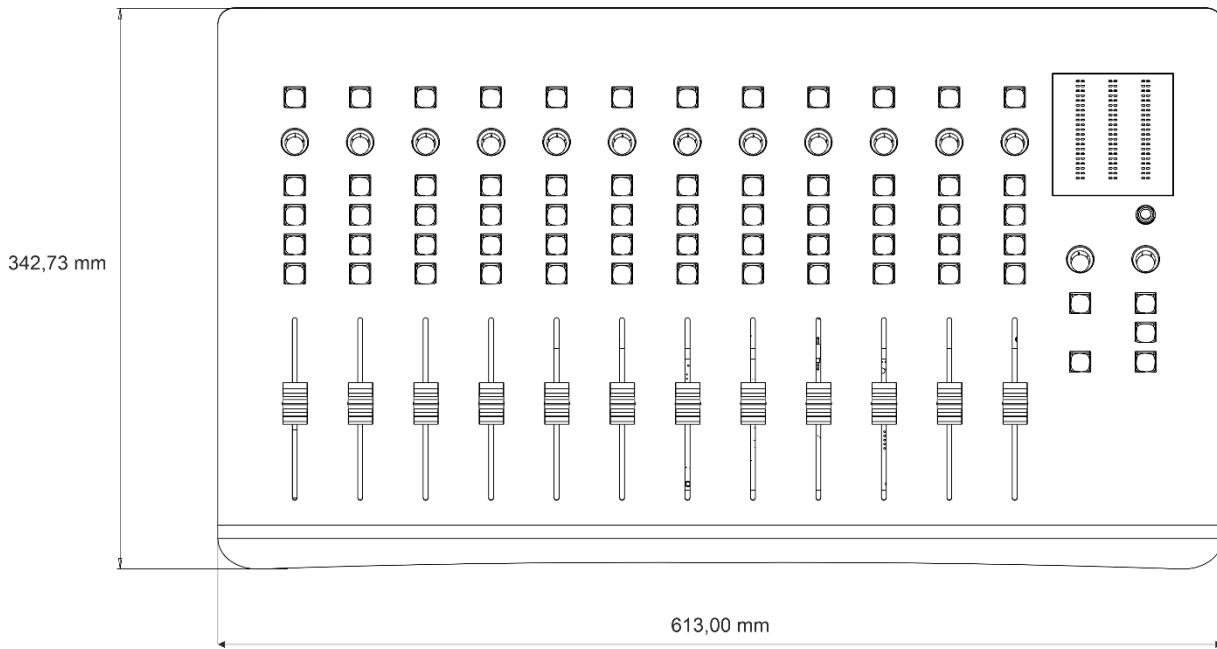

1.3 TALKBOX DIMENSIONS

TOP

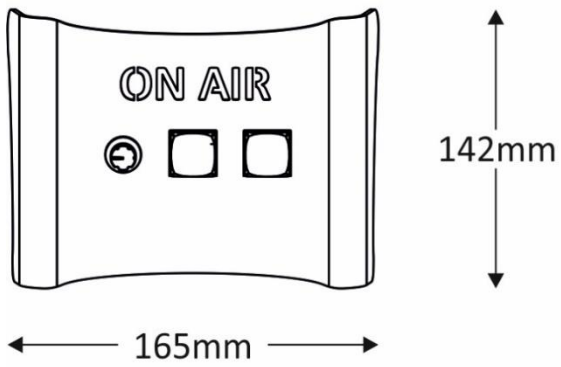

SIDE

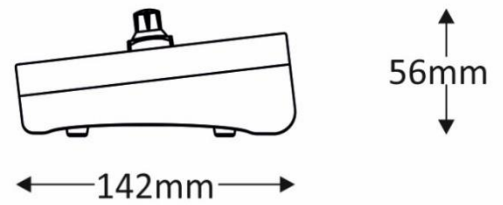

FRONT

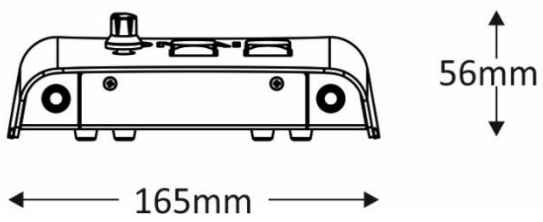

REAR

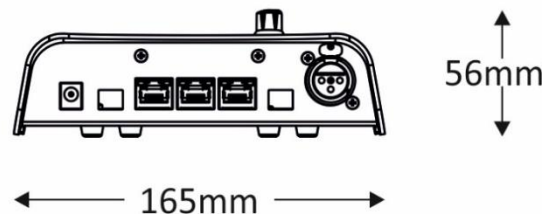

1.4 INPUT CONNECTIONS

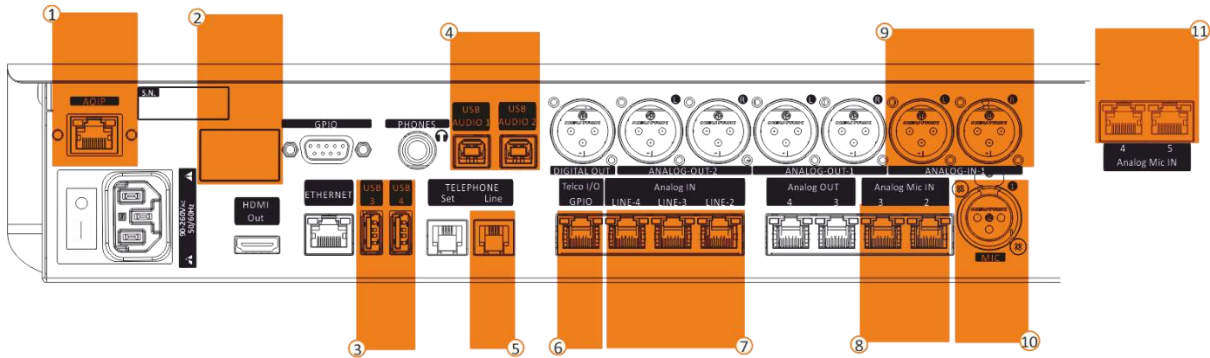

- 1. AOIP – LAN DANTE*** – RJ45 (CAT 6 cable).
8 Stereo digital audio inputs over Ethernet. These inputs are optional. If DANTE board was not purchased with the device these inputs are not enabled and do not work. Instead of these inputs, *USB AUDIO 1* and *USB AUDIO 2* inputs will be active. The first DANTE-1 audio input over Ethernet could be selected as 2 additional Telco Inputs: **TELCO4** and **TELCO5**.

You can set this option by:

SETUP / AUDIO / SETTINGS / INPUT MODE / DANTE 1 mode = 2 TELCO

- 2. Bluetooth***
Bluetooth Stereo/Mono Input - Wireless – Smartphone
- 3. USB 3, USB 4** ports Type A to Export and Import the mixer configurations and to customize the station LOGO
- 4. USB AUDIO 1, USB AUDIO 2**
2 Audio Card Stereo Input- USB-Type B - PC Connections. If DANTE board was purchased these ports will not be present and will be automatically disabled.
- 5. Telephone**
Analog Telephone Line Input - RJ11 – for POTS/PSTN interfacing.
- 6. Telco I/O GPIO** – RJ45 (SFTP cable). The RJ45 cable transports TELCO-Input and TELCO Output. Through RJ45 is also carried 2 GPIO signals. 1 GPI to get the incoming call signal by the flashing of the F1 button. 1 GPO to control the external hybrid device for hook and drop purposes.
Pinout – in scheme
+188 – Oxy1000-Oxy2000-RJ45-Telco

- 7. ANALOG IN (LINE-2, LINE-3, LINE-4)** – RJ45 (SPTF Cable) for a max of 3 Stereo analog audio inputs. By these connectors will be also possible to have one of the 2 following combinations:
 - 2 Stereo analog audio inputs and 2 Mono analog audio inputs.
 - 1 Stereo analog audio input and 4 Mono analog audio inputs.

Line 2 modes

Line 2 could be defined in one of the 2 following modes:

- 1 Stereo Line (by default)
- or
- 2 Mono Lines

The user can activate this mode by the OXYGEN REMOTER menu

SETUP / AUDIO / SETTINGS / INPUT MODE / LINE 2 mode = 2 MONO.

By the 2 MONO mode activation, instead of LINE 2, the user will be only able to choose MONO 3 (LINE-2-L) and MONO 4 (LINE-2-R).

Line 3 modes

Line 3 could be defined in one of the 2 following modes:

- 1 Stereo Line (by default)
- or
- 2 Mono Lines

The user can activate this mode by the OXYGEN REMOTER menu

SETUP / AUDIO / SETTINGS / INPUT MODE / LINE 3 mode = 2 MONO.

By the 2 MONO mode activation, instead of LINE 3, the user will be only able to choose MONO 5 (LINE-3-L) and MONO 6 (LINE-3-R).

Line 4

The only available mode for LINE 4 is 1 STEREO LINE.

Pinout - in scheme

+189 – Oxy1000-Oxy2000-RJ45-Line

- 8. ANALOG MIC IN 2, ANALOG MIC IN 3** - RJ45 (SFTP Cable) – cable for the Balanced Audio (Mic 2/3 Input) and for 2 GPI and for 1 GPO signals on each connector. These 2 ports are useful for 2 Talk Box interfacing.

Pinout - in scheme
+187 – Oxy1000-Oxy2000-RJ45-Mic

- 9. ANALOG-IN-1**
1 Stereo Input / 2 Mono / 2 Telco
on XLR Female - Balanced Audio Connection (10KΩ)

Line 1

Line 1 could be defined in one of the 3 following modes:

1 Stereo Line (by default)

2 Mono Lines

The user can activate this mode by the OXYGEN REMOTER menu

SETUP / AUDIO / SETTINGS / INPUT MODE / LINE 1 mode = 2 MONO.

By the 2 MONO mode activation, instead of LINE 1, the user will be only able to choose MONO 1 (LINE-1-L) and MONO 2 (LINE-1-R).

2 Telco (inputs)

The user can activate this mode by the OXYGEN REMOTER menu

SETUP / AUDIO / SETTINGS / INPUT MODE / LINE 1 mode = 2 TELCO.

By the 2 TELCO mode activation, instead of LINE 1, the user will be only able to choose TELCO 2 (LINE-1-L) and TELCO 3 (LINE-1-R).

- 10. MIC** – XLR Female – Balanced Audio Connection (1.2KΩ)

- 11. ANALOG MIC IN 4, ANALOG MIC IN 5**** RJ45 (SFTP Cable) – for Balanced Audio (Mic 4/5 Input) for 2 GPI and for 1 GPO signals on each connector. These 2 ports are useful for 2 Talk Box interfacing. ANALOG-IN-1 (*input scheme* - point 9.) and GPIO (*communication scheme* – point 2.) will be lost if these option should be requested.
Pinout - in scheme
+187 – Oxy1000-Oxy2000-RJ45-Mic

* Optional on both OXYGEN 1000 and OXYGEN 2000.

** Optional only on OXYGEN 2000

1.5 OUTPUT CONNECTIONS

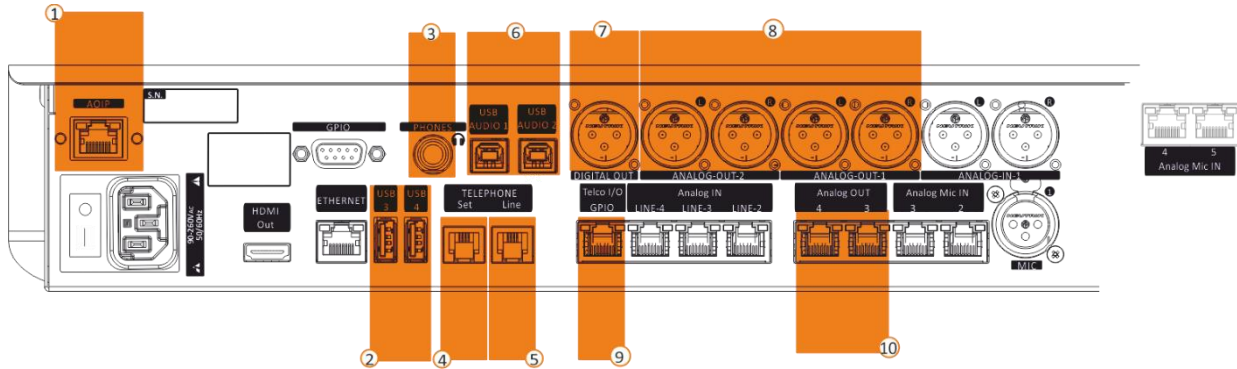

1. **AOIP – LAN DANTE*** – RJ45 (CAT 6 cable).
8 Stereo digital audio outputs over Ethernet. These outputs are optional. If DANTE board was not purchased when purchasing the device these outputs are not enabled and do not work. Instead of these outputs, *USB AUDIO 1* and *USB AUDIO 2* outputs will be active.
The first DANTE-1 audio output over Ethernet could be selected as 2 additional Telco N-1 Output (DANTE-Out-L and DANTE-Out-1-R) of the additional **Telco4** (Dante-In-1-L) and **Telco5** (Dante-In-1-R), to set this:
SETUP / AUDIO / OUTPUTS / DIGITAL
2. **USB 3, USB 4** ports Type A to Export and Import the mixer configurations.
Import LOGO
3. **HEADPHONES** on female Jack 6,3 mm connector for the audio monitoring with Control Room Headphones. This connector works in parallel with the following surface one:
4. **SET** connector on RJ11, to plug a POTS/PSTN telephone device to speak with the caller before airing him.
5. **Telephone**
Analog Telephone Line Input - RJ11 – for POTS/PSTN interfacing. On this connector pass both input and output signals.
6. **USB AUDIO 1, USB AUDIO 2**
2 Audio Card Stereo Input- USB-Type B - PC Connections. If DANTE board was purchased these ports will not be present and will be automatically disabled.
7. **DIGITAL OUT** (AESEBU) on XLR Male connector for the digital AESEBU output audio signal.
8. **ANALOG-OUT-1, ANALOG-OUT-2**
2 Stereo Output transporting - XLR Male - Balanced Audio Connection (23Ω nominal (600Ω)).
The ANALOG-OUT-1 is fixed on PGM BUS.
The ANALOG-OUT-2 usually is by default set for the Control Room-SPEAKERS.
If needed ANALOG-OUT-2 could be set as 2 Telco N-1 Outputs (ANALOG-OUT-2-L and ANALOG-OUT-2-R) of the additional **Telco2** and **Telco 3**.

You can activate this ANALOG-OUT-2 special mode by selecting between the 2 following exclusive options:
SETUP / AUDIO / OUTPUTS / ANALOG / OUT-2 / Source = N-1 T2/T3
This previous option allows to the TELCO 2 caller to listen to the TELCO 3 caller.
SETUP / AUDIO / OUTPUTS / ANALOG / OUT-2 / Source = N-1 T2+T3
This previous option does not allow the TELCO 2 caller to listen to the TELCO 3 caller.
9. **Telco I/O GPIO** – RJ45 (SFTP cable). The RJ45 cable transports TELCO-Input and TELCO Output. Through RJ45 is also carried 2 GPIOs signals. 1 GPI to get the incoming call signal by the flashing of the F1 button. 1 GPO to control the external hybrid device for hook and drop purposes.
Pinout – in scheme
+188 – Oxy1000-Oxy2000-RJ45-Telco
10. **ANALOG OUT 3, ANALOG OUT 4** - on RJ45 (SPTF Cable) for the STUDIO HEADPHONES and 1 GPO signal for ONAIR LIGHTS and TALKBOXES. Pinout - in scheme
+190 - Oxy1000-RJ45-LineOut

NB:

- The audio signal of the logical PGM audio BUS is automatically routed to the ANALOG-OUT-1 physical BUS.
- The audio signal of the PGM, SUB, AUX-1, AUX-2, SPK-CR, HDP-CR, SPK-ST, HDP-ST logical BUSS can be routed to the ANALOG-OUT-2, ANALOG-OUT-3, ANALOG-OUT4 physical audio BUSS.
- AUX1 and AUX2 logical BUSS are only available on the OXYGEN REMOTER controlling software and can be routed to the ANALOG-OUT-2, ANALOGUE-OUT-3, ANALOG-OUT-4.

1.6 COMMUNICATION CONNECTIONS

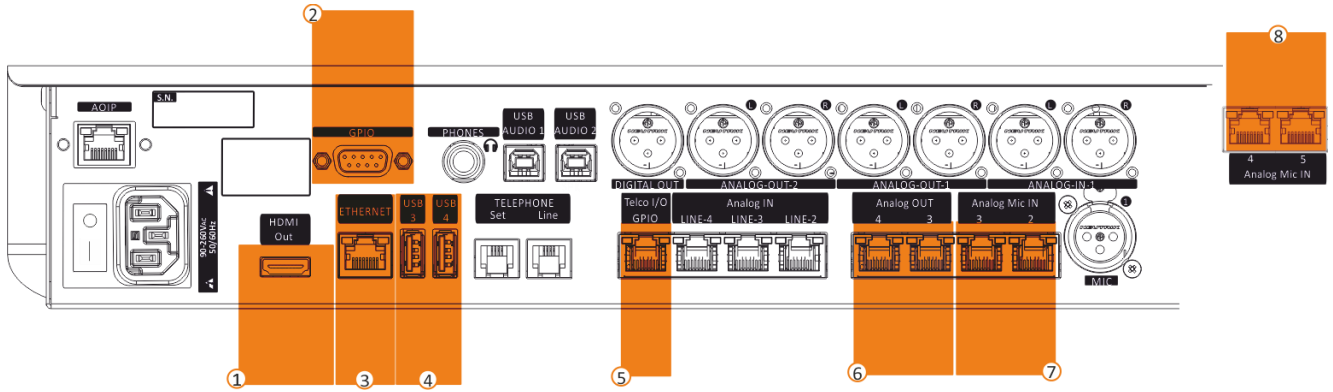

1. **HDMI Output**
Standard HDMI Female Connector – External Monitor.
2. **GPIO**
SUB-D 9p Female – 4 GPI + 4 GPO.
SubD9-GPIO scheme
3. **Ethernet**
RJ45 Female Connector (CAT 6) Internet Connections (online updates), Web interface, remote control, and monitoring.
4. **USB 3, USB 4**
ports Type A to Export and Import the mixer configurations.
Import LOGO
5. **Telco I/O GPIO** – RJ45 (SFTP cable). The RJ45 cable transports the TELCO Input, the TELCO Output and the GPIO signals to get the incoming call signal for flashing of button F1 and to control the external hybrid device for hook and drop purposes.
Pinout – in scheme
+188 – Oxy1000-Oxy2000-RJ45-Telco
6. **ANALOG OUT 3, ANALOG OUT 4** - on RJ45 (SPTF Cable) for audio HEADPHONES, 1 GPO signal for ONAIR LIGHTS and TALKBOXES.
Pinout - in scheme
+190 – Oxy1000-Oxy2000-RJ45-LineOut
7. **ANALOG MIC IN 2, ANALOG MIC IN 3** - RJ45 (SFTP Cable) – cable for the Balanced Audio (Mic 2/3 Input) and for 2 GPIs and for 1 GPO signals on each connector.
These 2 ports are useful for 2 Talk Box interfacing.
Pinout - in scheme
+187 – Oxy1000-Oxy2000-RJ45-Mic
8. **ANALOG MIC IN 4, ANALOG MIC IN 5**** RJ45 (SFTP Cable) – for Balanced Audio (Mic 4/5 Input) for 2 GPI and for 1 GPO signals on each connector.
These 2 ports are useful for 2 Talk Box interfacing.
ANALOG-IN-1 (*input scheme* - point 9.) and GPIO (*communication scheme* – point 2.) will be lost if these option should be requested.
Pinout - in scheme
+187 – Oxy1000-Oxy2000-RJ45-Mic

** Optional only on OXYGEN 2000

1.7 TALKBOX CONNECTIONS

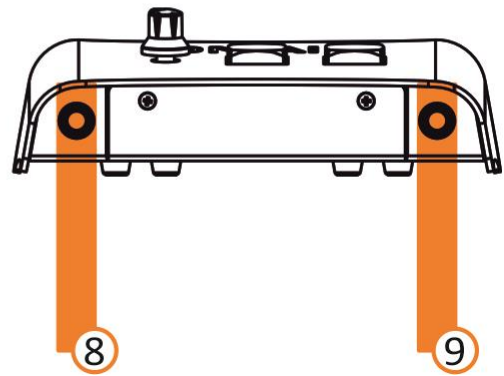
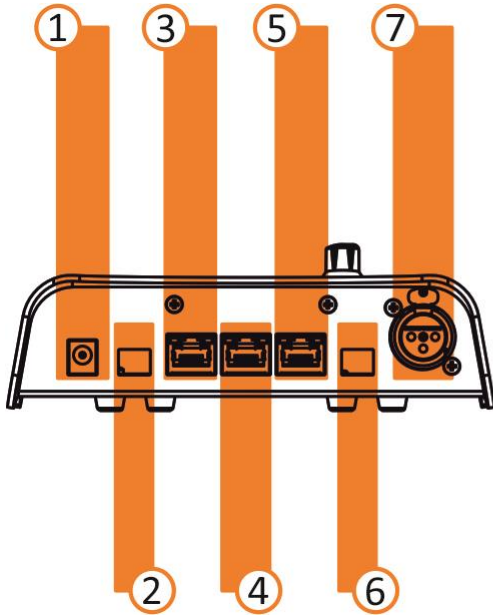

- | | |
|---|--|
| <ol style="list-style-type: none"> 1. Power Supply
12VDC 1A 2. Studio Light
2 PIN Screw Connector - (12VDC output). 3. HDP Output
RJ45 Connectors (SFTP) - (Passive Loop Output). 4. HDP Input
RJ45 Connectors (SFTP). 5. Talk Box Connection
RJ45 Connectors (SFTP) - (Passive Loop Output). | <ol style="list-style-type: none"> 6. Mic Light
2 PIN Screw Connector - (12VDC output). 7. Mic Input
XLR Female Connector. 8. HDP-1-TBox
Jack 6.3mm Female Connector - (Min. Imp. 32Ω). 9. HDP-2-TBox
Jack 6.3mm Female Connector - (Min. Imp. 32Ω). |
|---|--|

2. FIRST CONSOLE IP ADDRESS ASSIGNMENT

Connect a LAN cable to the **OXYGEN 1000** or to your **OXYGEN 2000** LAN port on the back panel of the device.

The device is automatically discoverable as DHCP client in your network.

Download the Oxygen Remoter setup file from the following URL:

[HTTPS://WWW.AXELTECHNOLOGY.COM/PUBLIC/OXYGENREMOTER/OXYGENREMOTERSETUP.EXE](https://www.axeltechnology.com/public/oxygenremoter/oxygenremotersetup.exe)

Launch the downloaded **OxygenRemoterSetup.exe** installation file

Open Oxygen Remoter by clicking on the **OxygenRemoter.exe** icon. You will see the following window:

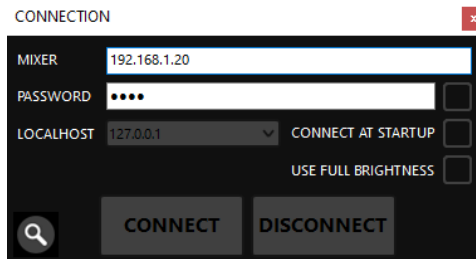
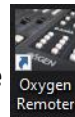

Click on the search device button on the mask bottom-left.

Look for your device into the following list:

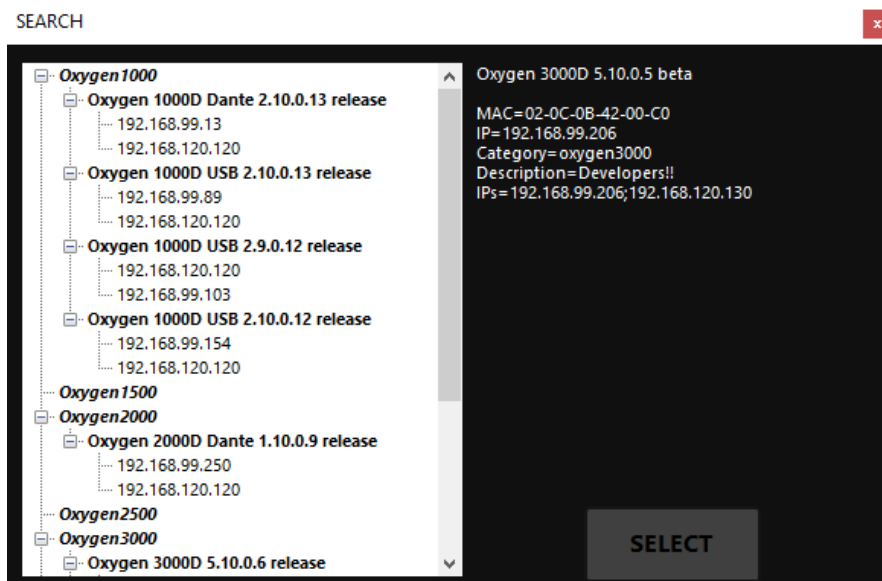

Click on your device

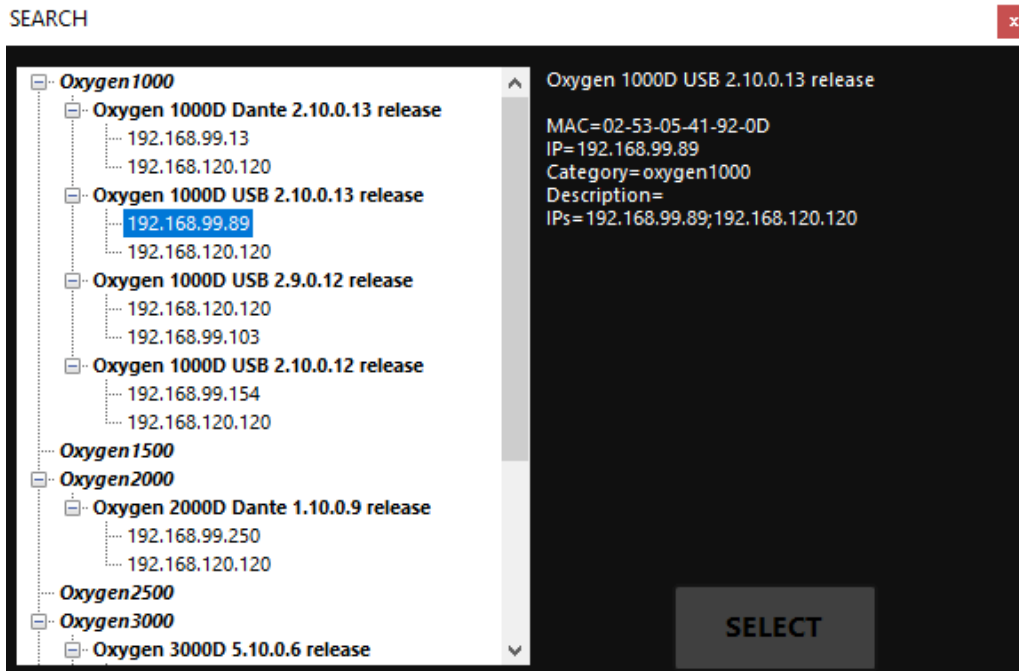

and click on

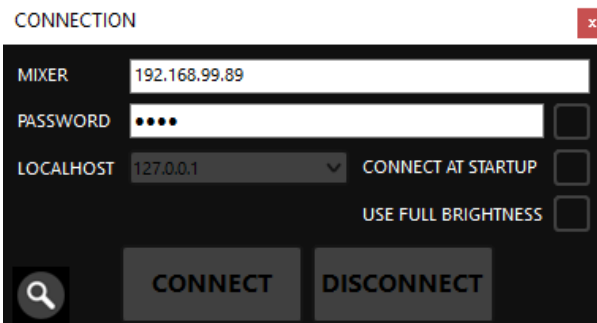

Then click on



to start the real-time communication with the target device.

NB: Default password: root

Localhost dropdown menu is used if you need to change your IP ADDRESS because of your second PC LAN board or your second IP Address:

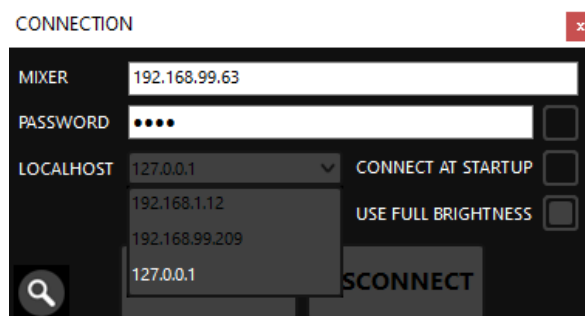

In **SETUP > GENERAL > COMMUNICATIONS > TCP-IP**

The screenshot shows the 'Settings' application window with the following configuration:

- Navigation:** MAIN / GENERAL / COMMUNICATIONS / TCP-IP
- Buttons:** < BACK
- Section:** GENERAL
- DHCP:** No
- Address 1:** 192.168.1.12/24
- Address 2:** 192.168.120.120/24
- Gateway:** 192.168.1.1
- DNS:** 8.8.4.4
- MAC:** 02:02:03:C1:3A:1C

If DHCP = **YES**, the console IP ADDRESS-1 will be automatically assigned by your router.

If DHCP = **NO**

Type the desired IP ADDRESS in the **ADDRESS 1** field. This parameter is useful to remotely control your device.

We suggest you to do not change the **ADDRESS 2** field, useful for Axel Support purposes.

Specify your gateway in **GATEWAY** field. Without this specification, your device is not able to find out any update if available.

You can specify a desired DNS (admitted also the primary 8.8.8.8 or the secondary 8.8.4.4 google DNS) into **DNS** field.

Your MAC-ADDRESS is automatically assigned to the console during its production.

After all the settings, we suggest you to close your OXYGEN REMOTER and to restart the console by backpower button.

Open again OXYGEN REMOTER and you can connect to the new console IP ADDRESS from the following mask:

The screenshot shows the 'CONNECTION' screen with the following fields and options:

- MIXER:** 192.168.99.189
- PASSWORD:** [masked]
- LOCALHOST:** 127.0.0.1
- CONNECT AT STARTUP:**
- USE FULL BRIGHTNESS:**
- Buttons:** CONNECT, DISCONNECT

3. SURFACE

To analyze the console surface we can split OXYGEN 1000 and OXYGEN 2000 in the following 4 same partitions:

OXYGEN 1000 - SECTIONS



- 1. CHANNEL CONTROLS
- 2. OUTPUT LEDMETERS
- 3. MONITORS SECTION
- 4. BLUETOOTH BUTTON

OXYGEN 2000 - SECTIONS

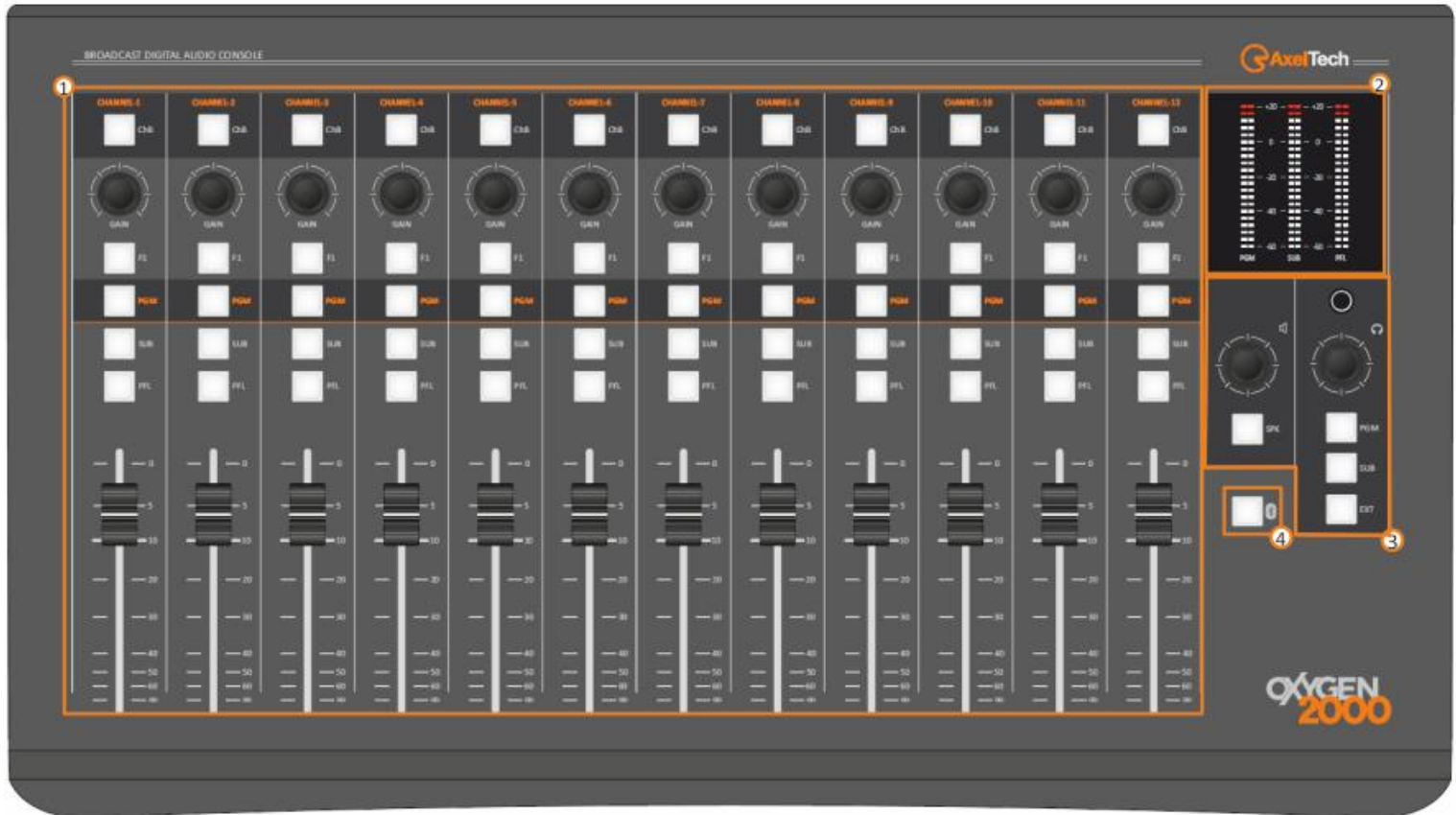

1. CHANNEL CONTROLS

2. OUTPUT LEDMETERS

3. MONITORS SECTION

4. BLUETOOTH BUTTON

3.1 CHANNEL CONTROLS

- A. CHB – BUTTON FOR SOURCE SWITCHING BETWEEN PRIMARY SOURCE (CHA) AND THE SECONDARY ONE (CH B)
- B. GAIN – KNOB FOR THE ADJUSTING OF THE INPUT SOURCE LEVEL
- C. F1 – BUTTON FOR THE INCOMING CALL SIGNALLING AND TO HOOK AND DROP THE CALL ON THE RELATED PHONE LINE (TELEPHONE, TELCO OR BLUETOOTH)
- D. PGM – BUTTON TO ENABLE THE PGM BUS
- E. SUB – BUTTON TO ENABLE THE SUB BUS
- F. PFL – BUTTON TO ENABLE THE PFL BUS
- F. FADER – THE FADER ALLOWS THE SOURCE LEVEL ATTENUATION

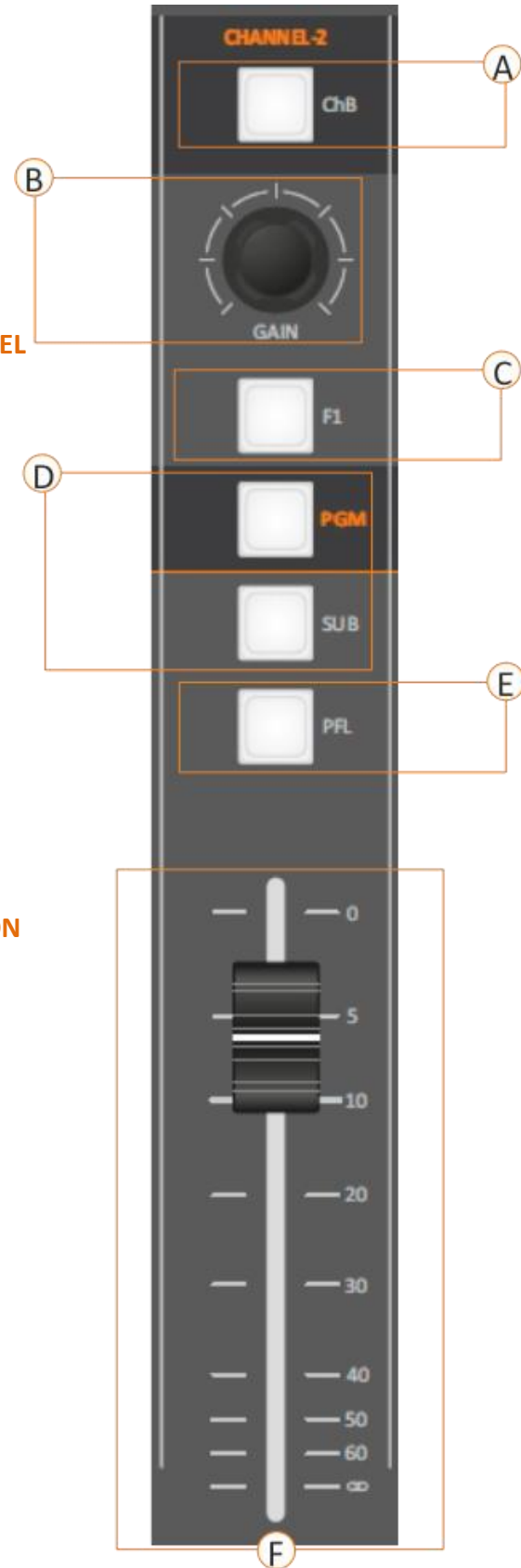

A. ChB BUTTON

For every channel, you can set two different input sources, **ChA** and **ChB**.
By pressing **the ChB** button, you can switch over between **A/B** sources.

Button in **OFF** position: the **ChA** is active.

Button in **ON** position: the **ChB** is shown. The button starts lighting.

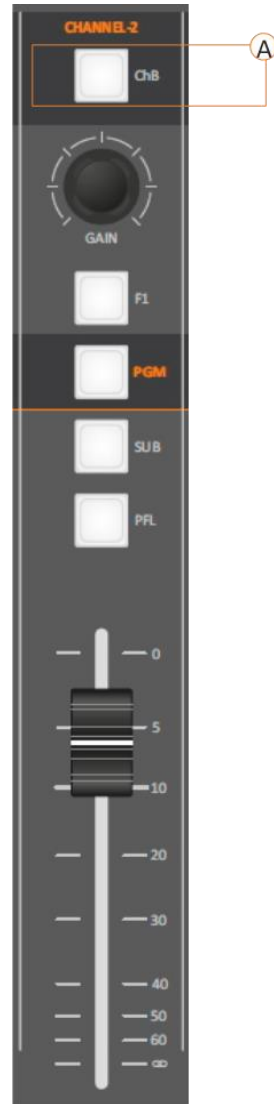
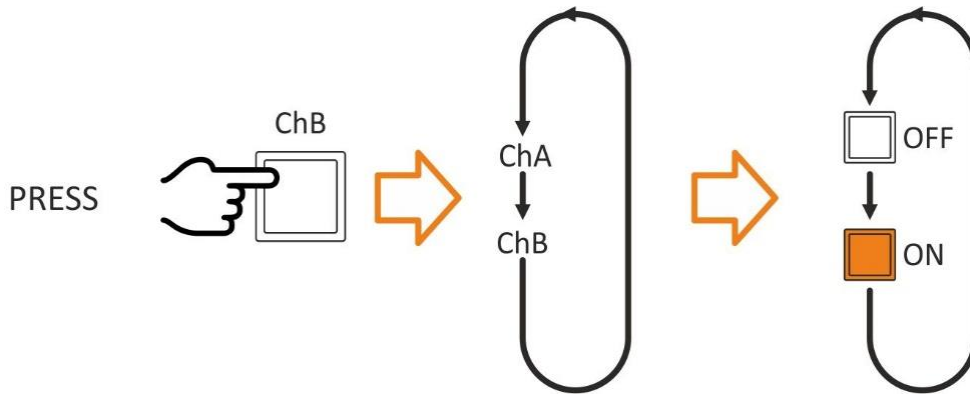

ATTENTION: If the source is already aired on a different channel it will be aired to the last one too. The faders will be added accordingly with the **BUS** selection.
If Channel **B** is aired you cannot assign to it the **EMPTY** source.

The CHB button functioning is possible by the following button of the OXYGEN REMOTER:

CH-A ON

In this example the activated source is DANTE 2



CH-B ON

In this example the activated source is STEREO 2



You also have another OXYGEN REMOTER section in which you can define the audio sources (A and B) from the menu:

MAIN / AUDIO / CHANNELS

SETUP

×

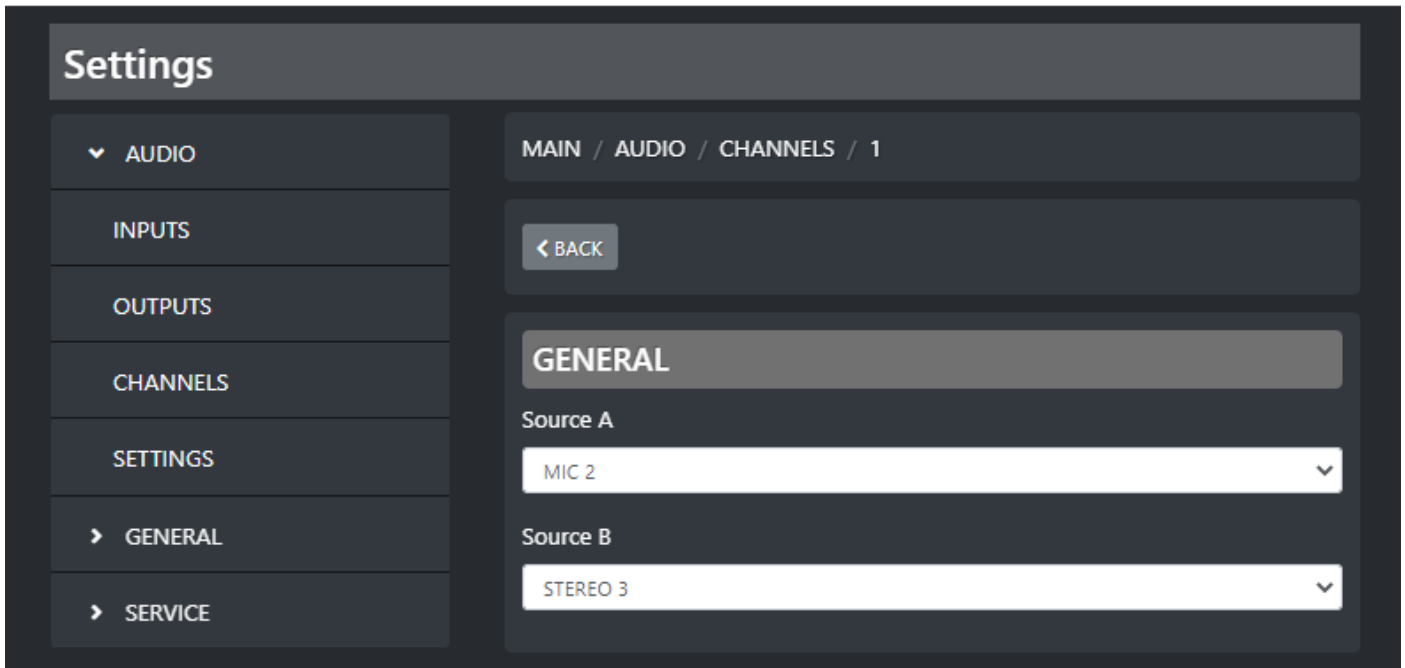

Settings

- ▼ AUDIO
- INPUTS
- OUTPUTS
- CHANNELS
- SETTINGS
- ▶ GENERAL
- ▶ SERVICE

MAIN / AUDIO / CHANNELS / 1

< BACK

GENERAL

Source A
MIC 2

Source B
STEREO 3

B. GAIN

The **GAIN** knob rotation increases or decreases the input source gain.

The **GAIN** value is associated with the selected source **ChA/ChB**, not with the physical channel.

By switching the source, the gain is always suitable to the connected one.

The **GAIN** value is the latest setting is seated by the knob.

The **GAIN** affects the input level with **+/- 20 dB**.

Rotate a **GAIN** knob, it's will active the **SET** mode and shows the setting and **GAIN** level at the display.

The step of the **GAIN** adjustment knob is **0.1 dB**.

The GAIN button functioning is possible by the following control of the OXYGEN REMOTER:

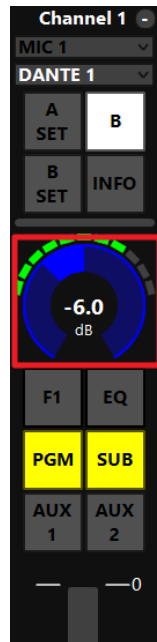
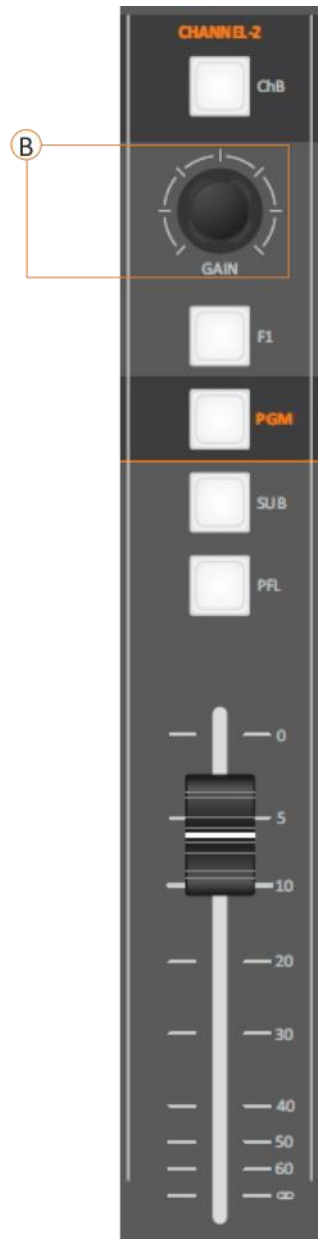

The pressure of the GAIN knob allows you to enter into the SOURCE ASSIGNMENT mode for the related channel, as you can see by the following HDMI-output capture:



The rotation of the same GAIN knob allows you the source selection between the available ones.



Press the same GAIN knob to confirm the selection. As you can see by the following picture, according with our example, the GAIN to be pressed is the one related to CHANNEL-1:



Not pressing again the relevant GAIN knob will not apply any changes to the current source. After a while this selection window will automatically close.

C. F1 BUTTON

Telephone Channel / Telco (Default Setting).

The same parallel workflow could be executed from the device surface or from the OXYGEN REMOTER control software as explained by the below image:

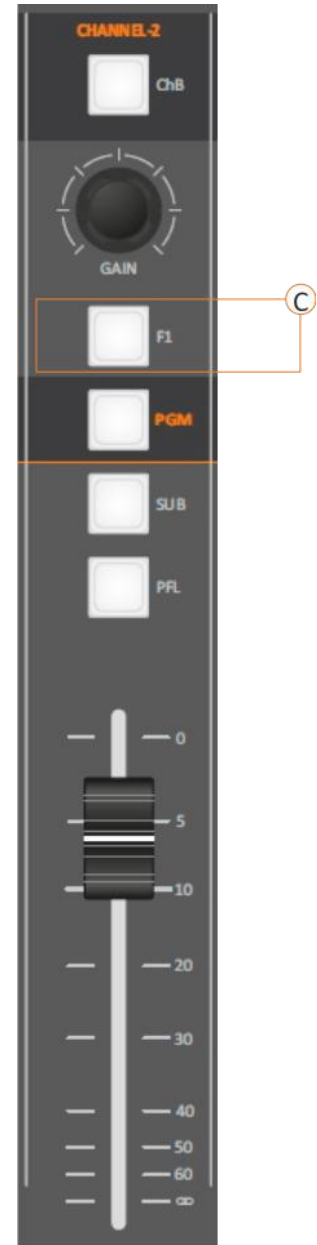
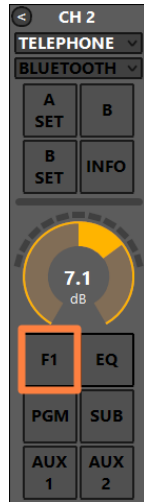

In the presence of an incoming call, the **F1** button starts blinking. By pressing **F1** it will hook the call.

- **F1** LED off – the line is not hooked.
- **F1** LED blinks – RING – there is an incoming call.
- **F1** LED on – the line is hooked.

By pressing **F1** again you drop the line.

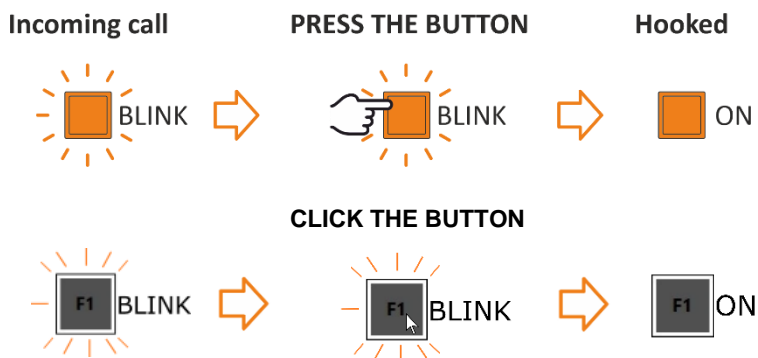

D. PGM/SUB BUTTONS

The **PGM**, **SUB** buttons forward or not the output signal to the related **BUSS**,

*PGM and SUB are 2 logical audio **BUSS** not 2 phisical audio **BUSS**.*

the RGB LEDs under the related button has three different states color:

- 1) disabled (LED OFF)
- 2) enabled + Channel ON
- 3) enabled + Channel MUTE/Warm state

The different status of these two **BUSS** button is always related with the channel (in this example CHANNEL-2).

When a channel switches from ON to OFF or to the standby status (by fader or by the Oxygen Remoter ON button), the related LEDs switches from ON Colour to Standby color. This function allows the user to understand the channel and the BUS status.

As you can see by the following picture by OXYGEN REMOTER side



you have 2 more additional audio BUSS: **AUX-1**, **AUX-2**.



AUX-1 and **AUX-2** are only settable and usable by **OXYGEN REMOTER** control software.

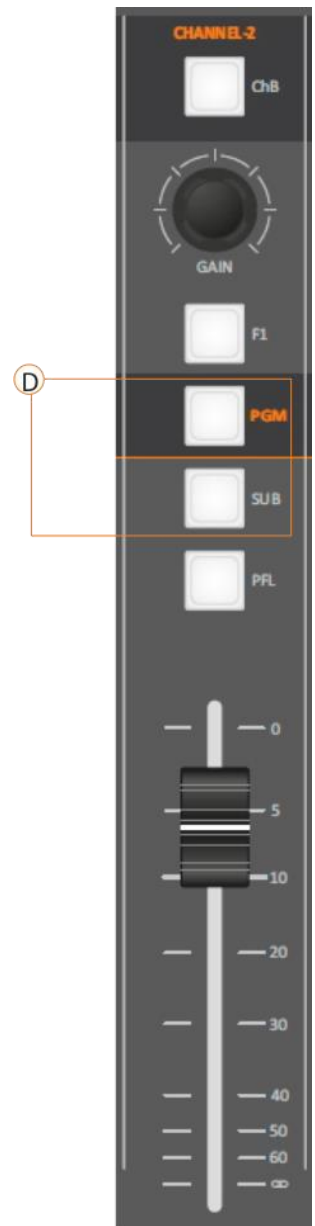

ON/OFF channel status could depend on:

- ON/OFF of the OXYGEN REMOTER **ON** button.
- **Fader** position changeable by
 - the console surface
 - OXYGEN REMOTER control software

**BUS PRESSURE BY
OXYGEN 3000 SURFACE**
(in this example PGM bus)

**ON PRESSURE ONLY BY
OXYGEN REMOTER**

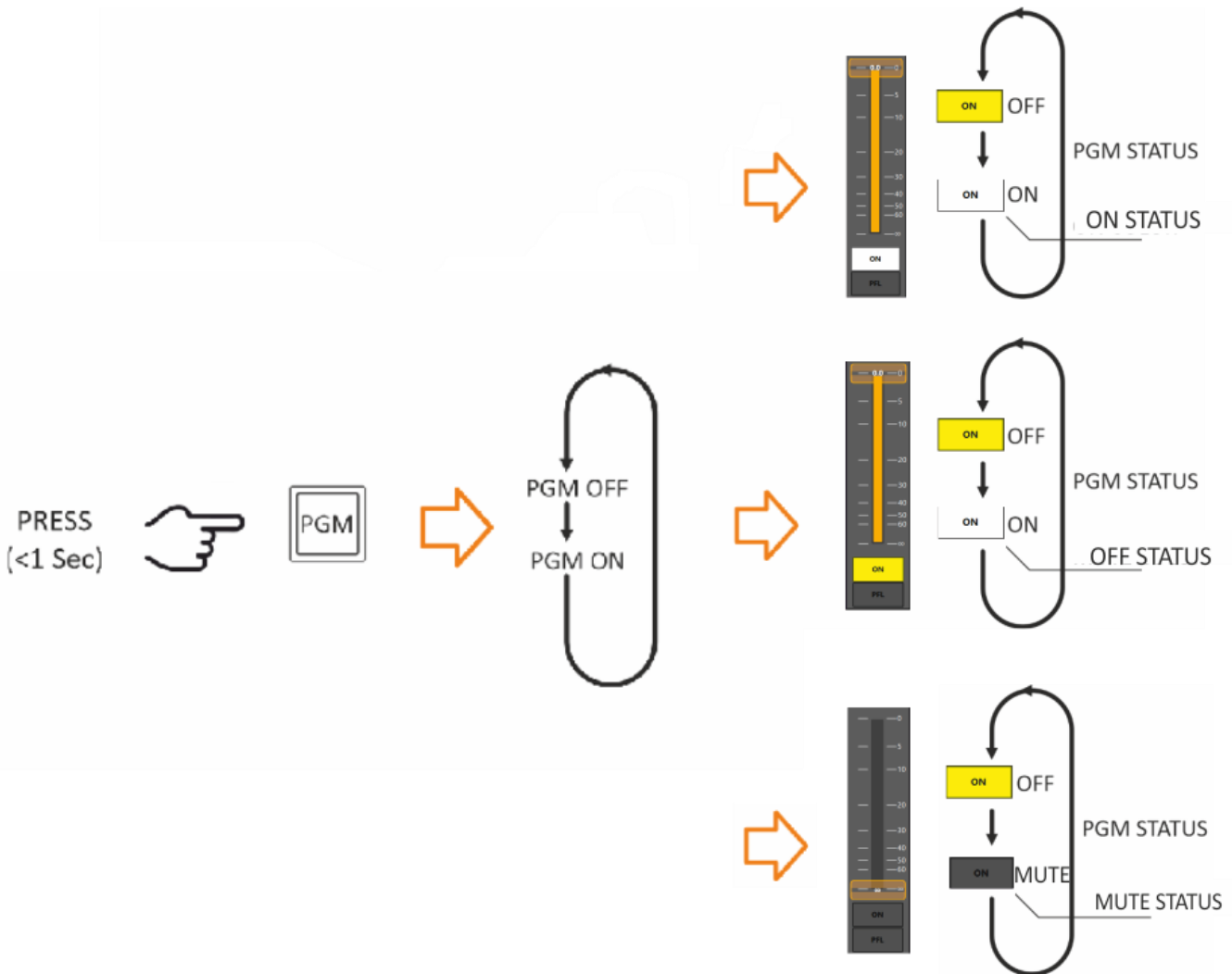

*NB: It's possible to set **AUX-1** and **AUX-2** to be **POST-Fader**, **PRE-Fader**, or **PRE-FADER ALWAYS ON**. This choice is settable from the OXYGEN REMOTER settings menu of every channel input source.*

*In example into the menu: **MAIN / MENU / AUDIO / INPUTS / MIC/MONO / MIC 1***

E. PFL

PFL button enables/disables the channel **pre-listening**.

When the PFL LED is ON, the pre-listening is enabled on that channel.

The 2 different status of this **PFL** button is always related with the channel (in this example CHANNEL-2).

Changing the source, the **PFL** status will not change.

The PFL has the same workflow by the

-console surface  button

and by the

-OXYGEN REMOTER  button

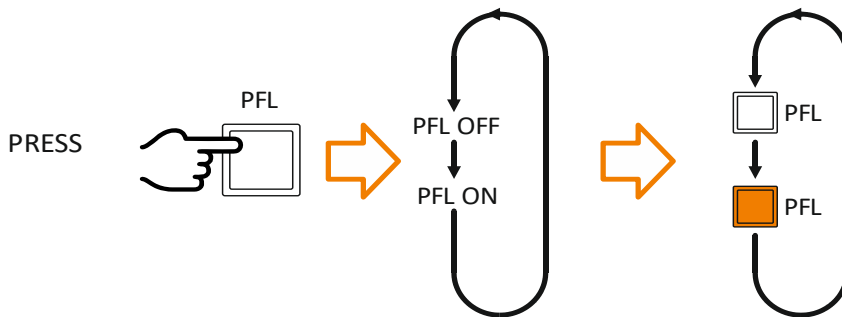

By pressing an enabled **PFL** you will disable it from the MONITOR pre-listening.

The **PFL** affects every headphone or speaker monitor previously set as **+PFL** mode. like (**SEL+PFL**, **1SEL+PFL** or **2SEL+PFL**).

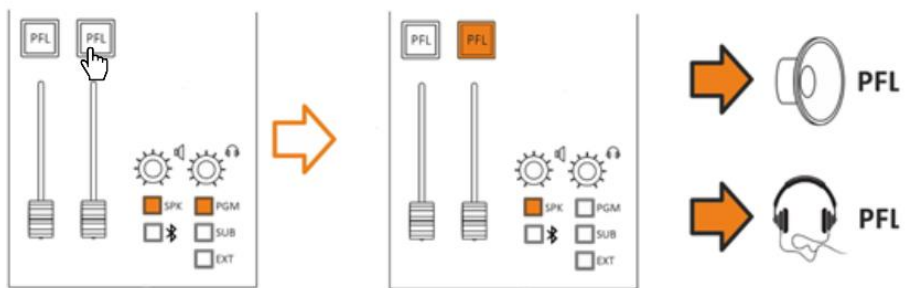
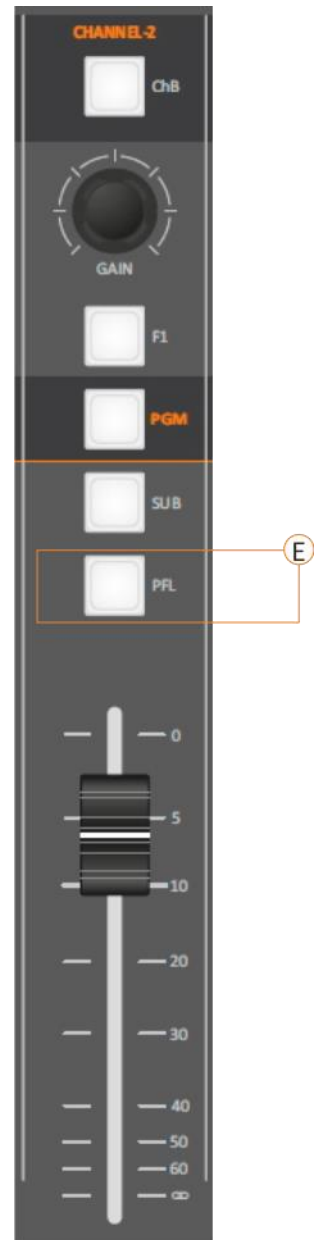

For example:

To active PFL in Control Room speakers (**SPK-CRM**), follow up this path to change the mode to **+PFL**

MENU / AUDIO / OUTPUTS / MONITOR / SPEAKER / SPK-CRM / MODE

(1SEL+PFL, 2SEL+PFL)

By going to **MAIN / AUDIO / SETTINGS** can change the **PFL MODE** between **SINGLE PFL** and **SUM PFL**.

SINGLE PFL: Allowed to select/listen to only one PFL per time.

SUM PFL: Allowed to select many PFL and listening to them all at the same time as shown in the following picture:

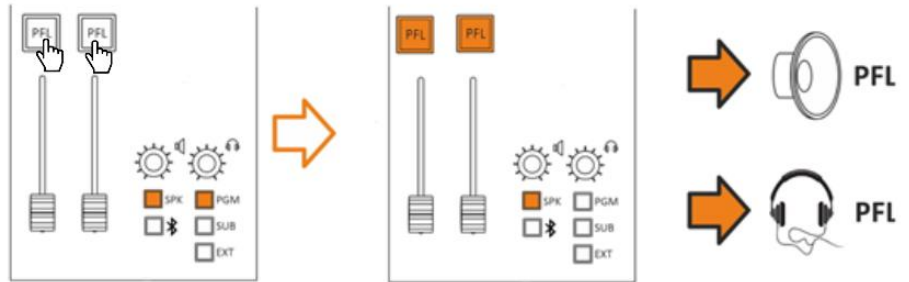

F. FADER

A command is generated every time the Fader passes through the threshold value:

ON - crossing the threshold point from bottom to top.

OFF - crossing the threshold point from top to bottom.

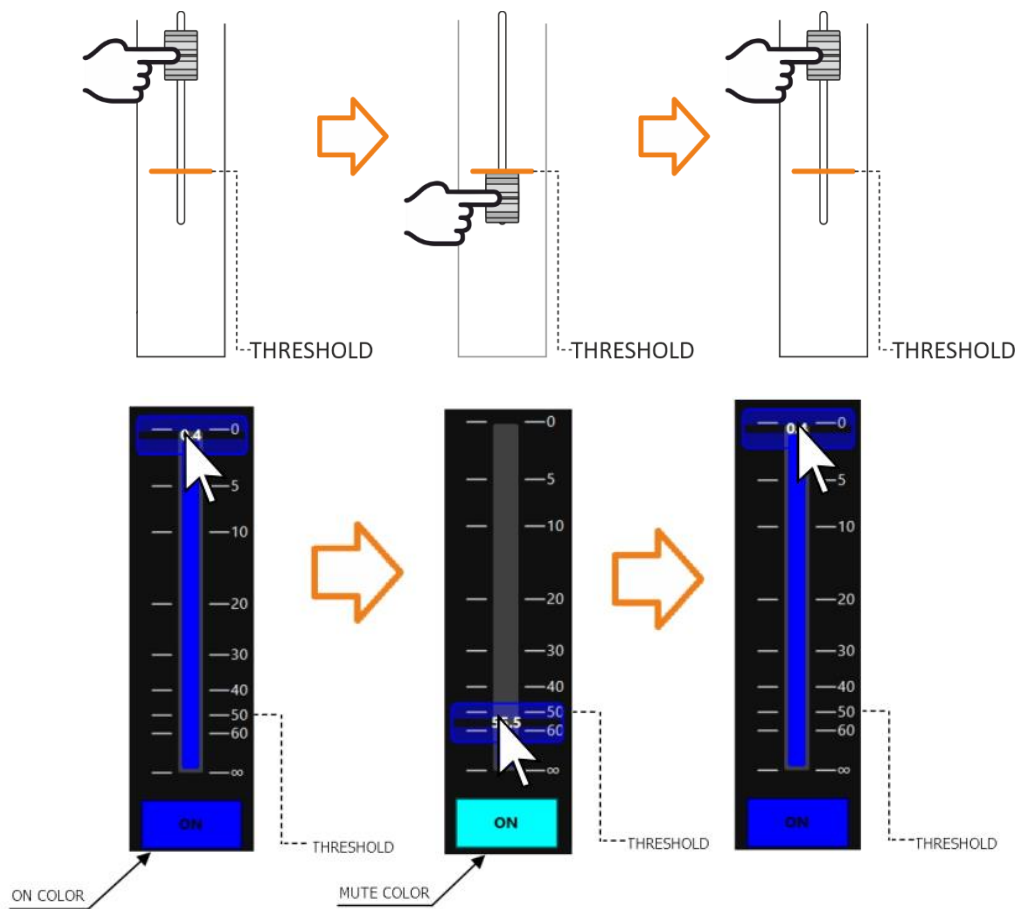

Differently by **EQ** and **GAIN**, **FADER** status is not associated with the source, it is associated with the physical channel. Changing the source, the **FADER** attenuation and the **FADER** position will not change.

ATTENTION:

It is possible to set **AUX-1** and **AUX-2** to be **POST-Fader** or **PRE-Fader**. The **FADER** does not affect the signal in the **PRE-FADER** case.

3.2 OUTPUT LEDMETERS

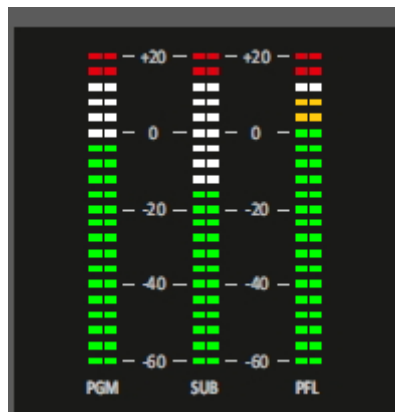

From these 3 ledmeters you can see the audio level for the related following audio BUSS, from left to right:

- PGM
- SUB
- PFL

3.3 MONITORS SECTION

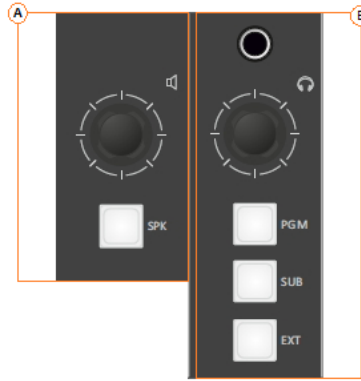

A. CONTROL ROOM SPEAKER SECTION

By this Speaker Monitor section you can:

- adjust the output audio of the Control Room Speakers



- This section is used for the management of the **Control Room Speakers**, by default set on ANALOG-OUT-2.
- The rotary control knobs allow you to **amplify/attenuate** the audio level.
- The loudspeakers audio level goes from **0** to **99** is the maximum allowed level. Can set the maximum level by going to this page:
SETUP / AUDIO / OUTPUTS / MONITOR / SPEAKER / SPK-CRM
- The step of the loudspeaker adjustment is **1 dB** and the level goes from **-80 dB** to the maximum of **+19 dB**.
- By **pressing the knob**, you can mute  or unmute the Control Room Speakers if it is already muted.

When the Control Room Speakers are on mute, by Oxygen Remoter side you will see the following squared signalling:



- To unmute the speaker 🗣️ just press their knob or **increase/decrease** the audio level by rotating the knob.
- The Control Room Speakers level is displayed in the bottom-right section of the HDMI output screen:



By remoter side you can change the same parameter by the following squared controller:

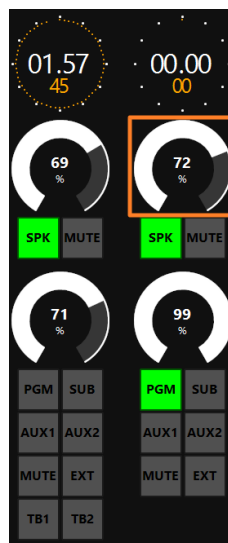

➤ check the CUT mode indicator:

- if SPK button is red, the Control Room speakers are currently in CUT mode with a MIC
By remoter side you will have the following state:

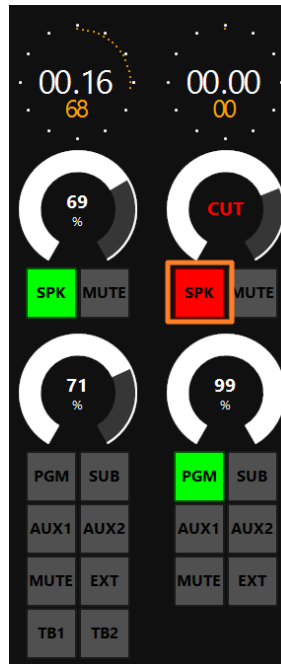

- if SPK button is green, the Control Room speakers are NOT currently in CUT mode with a MIC.

By remoter side you will have the following state:

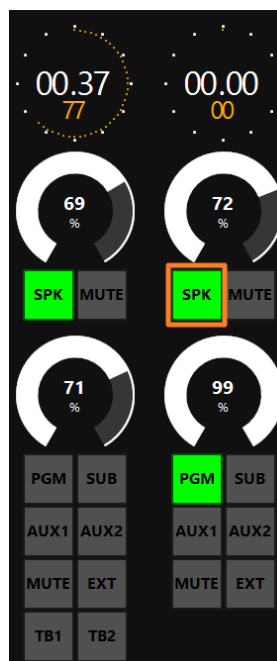

B. MONITOR HEADPHONES CONTROLS

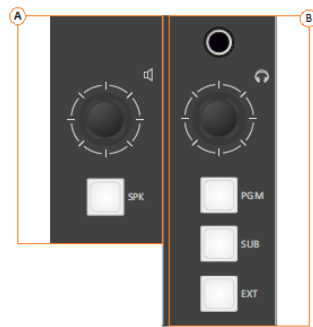

Connect the Control Room Headphones in the female Jack 6,5 mm connector below:



The connector is in parallel with the following one in the back panel:

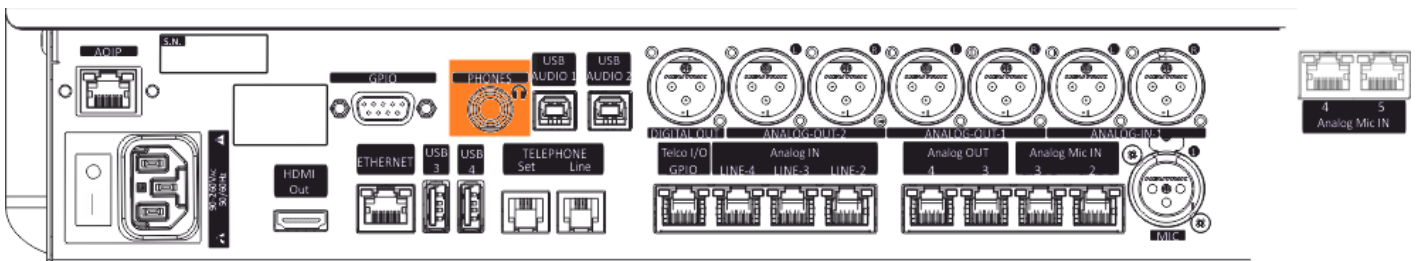

Adjust the Control Room Headphones by the following knob controller.



- This section is used for the management of the **Control Room Headphones**.
- The rotary control knobs allow you to **amplify/attenuate** the audio level.
- The loudspeakers audio level goes from **0** to **99** is the maximum allowed level. Can set the maximum level by going to this Oxygen Remoter menu: **SETUP / AUDIO / OUTPUTS / MONITOR / HEADPHONES / HDP-CRM**
- The step of the headset adjustment is **1 dB** and the level goes from **-80 dB** to the maximum of **+19 dB**.
- By **pressing the knob**, you can mute  or unmute the Control Room Headphones if it is already muted. When the Control Room Headphones are on mute, by Oxygen Remoter side you will see the following squared signalling:



- To unmute the Headphones  just press their knob or **increase/decrease** the audio level by rotating the knob.
- The Control Room Headphones level is displayed in the bottom-right section of the HDMI output screen:



By remoter side you can change the same parameter by the following squared controller:

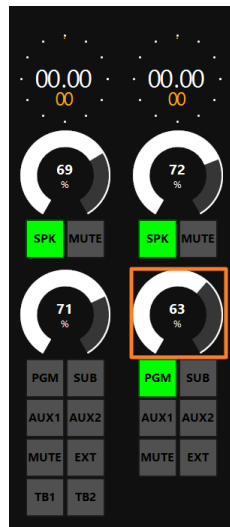

By following buttons select which is the audio BUS that you want to monitor by control room headphones and speakers:



*NB: you can define the desired EXT source by the following OXYGEN REMOTER menu
SETUP / AUDIO / SETTINGS / EXT. INPUT*

C. CONTROL ROOM SPEAKERS / MODE

SETUP / AUDIO / OUTPUTS / MONITOR / SPEAKER / SPK-CRM / MODE

MODE: 1SEL, 1SEL+PFL, 2SEL or 2SEL+PFL

PFL (pre-fader listening): This mode allows you to listen in speakers to the audio of the single-channel **before** the intervention of the fader.

1SEL (one selection): This option allows you to listen in speakers to only ONE selected output from output section (PGM, SUB, EXT by surface and Oxygen Remoter, AUX1, AUX2 only by Oxygen Remoter).

1SEL+PFL: This mode allows you to listen to **ONE selected output** or **PFL** if the PFL button is pressed in a channel.

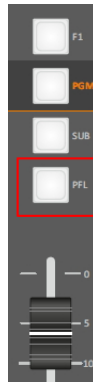

2SEL (two selection): This option allows you to listen to ONE selected output (PGM, SUB, EXT) in SPK-CRM, and by pressing the **SPK** button you will be able to select a different output to be listen on HDP-CRM.

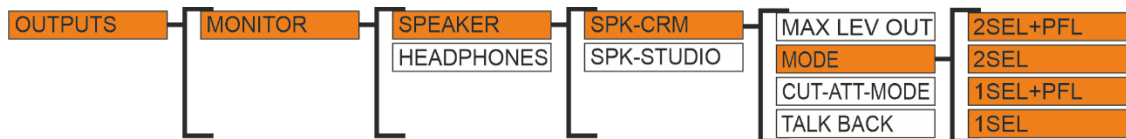
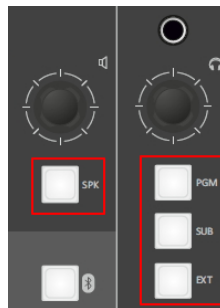

EX.: if you need to listen to different output in **SPK-CRM** Control Room Speakers, select the **2SEL** mode from the setting and press the **SPK** button in section (it will show up in warm color), then press any other output button from section (it will show up in warm color) to hear that output in the speakers only. (see the next figure).

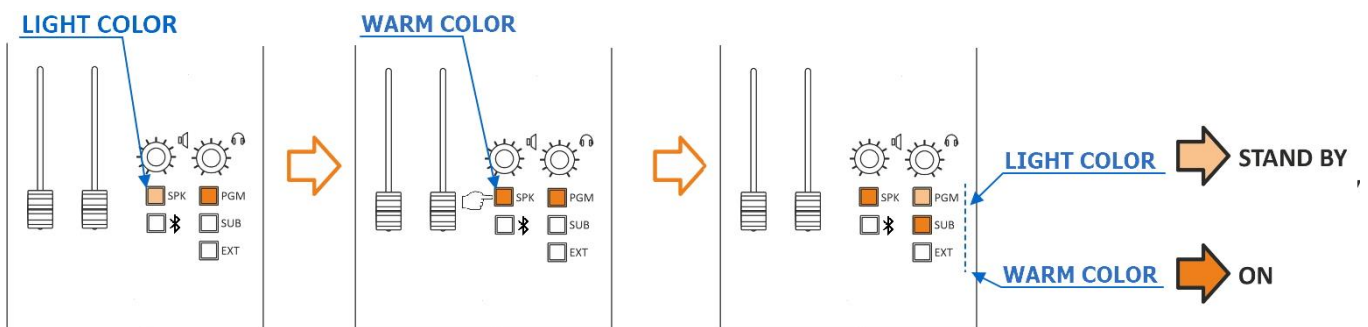

2SEL+PFL: This mode allows you to listen to ONE selected output (PGM, SUB, EXT) in SPK-CRM, and by pressing the **SPK** button you will be able to select a different output to be listen on HDP-CRM. You will listen PFL if PFL button is pressed in a channel.

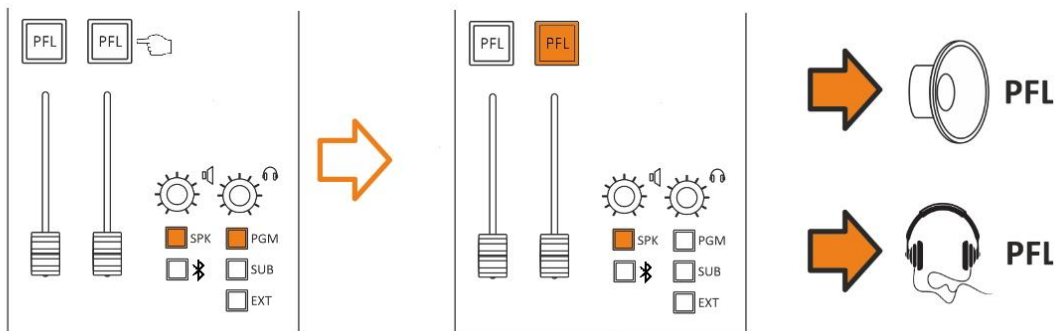

D. CONTROL ROOM SPEAKERS / CUT-ATT-MODE

SETUP / AUDIO / OUTPUTS / MONITOR / SPEAKER / SPK-CRM / CUT-ATT-MODE

CUT MODE: it's allowed the microphone to **CUT OFF** the audio of control room loudspeakers once the microphone goes to ON.

The opening of a microphone channel (if configured appropriately) can generate the closing command of the loudspeakers.

That is possible to choose one or more microphone to cut the loudspeaker output of the **CR** "Control Room" by following this path:

SETUP / AUDIO / INPUTS / MIC / SPK-CUT (OFF, ST, CR, CR+ST)

When you select **CR**, press down the knob to confirm the selection and the CUT indicator will blink as described by the following picture.

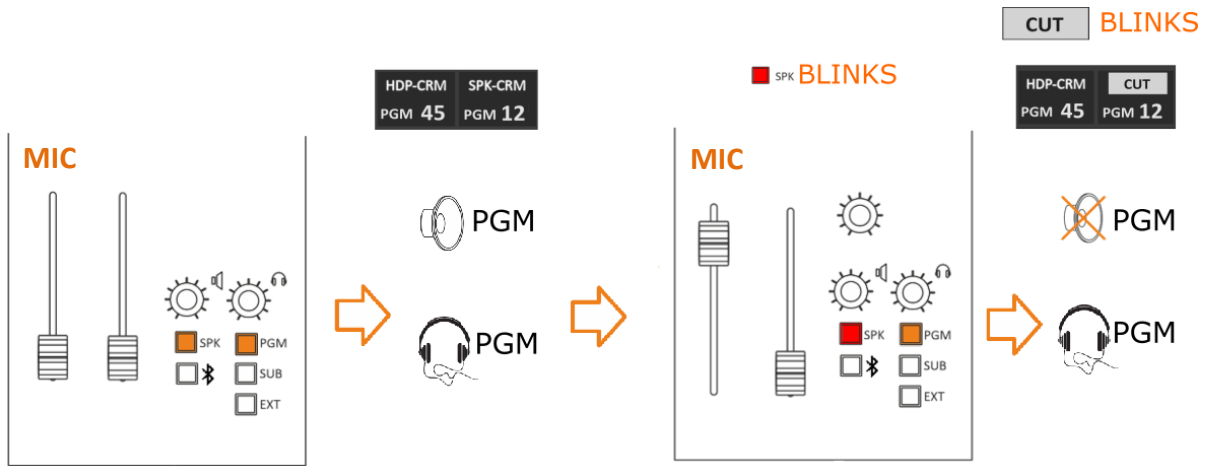

When you open the associated source with a **CUT** function you will see it will **MUTE** CR Loudspeakers output to prevent LOOP audio and the SPEAKER icon at LCD will start blinking.

ATT. (attenuation) MODE: It helps reduce acoustic flux from flowing into the speakers. It possible to decrease the speakers output -40, -30, -20 or -10 dB.

EX.: If we want to reduce the sound coming out of the speakers by **40 dB** less than the current value, then we have to choose **-40**. The same thing if we want to reduce the current volume when opening any of the microphones with a value of **10** decibels, then we have to choose **-10** and confirm the selection by pressing the button around until the selection color changes to yellow.

The **CUT** mode is triggered by the change from **OFF** to **ON** of a microphone source to which it has been set closing of the loudspeaker.

As shown in the MENU this function (**CUT**) is associated only with the loudspeakers, to avoid LARSEN effects “feedback loop” from occurring between the nearby loudspeakers and On-Air microphones.

On the other hand, if you need to **MUTE** the loudspeakers manually just **PRESS** the volume knob down. **PRESS** the volume knob a second time or rotate it to activate the loudspeakers output and amplification or attenuation. The status of **MUTE-SPK** is indicated by a red cross on the SPEAKER icon.

PUSH IT DOWN

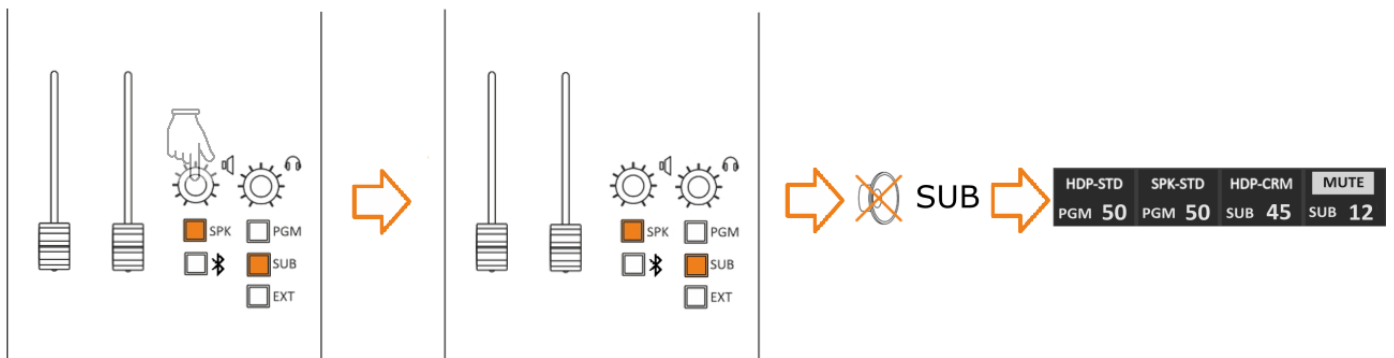

E. CONTROL ROOM HEADPHONES / MODE

SETUP / AUDIO / OUTPUTS / MONITOR / HEADPHONES / HDP-CRM / MODE

MODE: SEL, SEL+PFL

PFL (pre-fader listening): This mode allows you to listen in headphones to the audio of the PFL-channel **before** the intervention of the fader.

SEL (selection): This option allows you to listen in headphones the selected output from output section (PGM, SUB, EXT by surface and Oxygen Remoter, AUX1, AUX2 only by Oxygen Remoter).

SEL+PFL (selection and pre-fader listening): This mode allows you to listen in headphones the selected output or **PFL** if the PFL button is pressed in a channel.

F. STUDIO SPEAKERS / MODE

SETUP / AUDIO / OUTPUTS / MONITOR / SPEAKER / SPK-STUDIO / MODE

MODE: SEL, SEL+PFL, 2SEL or 2SEL+PFL

PFL (pre-fader listening): This mode allows you to listen in SPK-STUDIO to the audio of the single-channel **before** the intervention of the fader.

SEL (one selection): This option allows you to listen in SPK-STUDIO to only ONE selected output from output section (PGM, SUB, EXT, AUX1, AUX2 only by Oxygen Remoter).

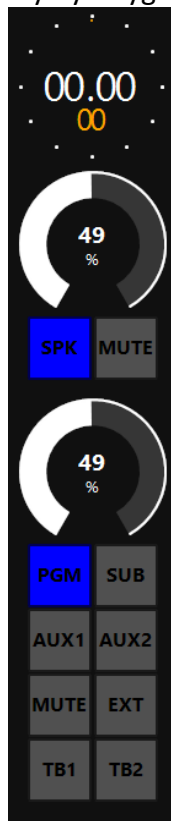

SEL+PFL: This mode allows you to listen to **ONE selected output** or **PFL** if the PFL button is pressed in a channel.

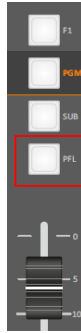

2SEL (two selection): This option allows you to listen to ONE selected output (PGM, SUB, EXT, AUX1, AUX2 only by Oxygen Remoter) in SPK-STUDIO, and by pressing the  button you will be able to select a different output to be listen on HDP-STUDIO.

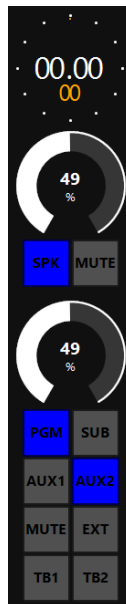

2SEL+PFL: This mode allows you to listen to ONE selected output in speakers (PGM, SUB, EXT) in SPK-STUDIO, and by pressing the **SPK** button you will be able to select a different output to be listen on HDP-STUDIO. You will listen PFL if PFL button is pressed in a channel.



G. STUDIO SPEAKERS / CUT-ATT-MODE

SETUP / AUDIO / OUTPUTS / MONITOR / SPEAKER / SPK-STUDIO / CUT-ATT-MODE

CUT MODE: it's allowed the microphone to **CUT OFF** the audio of control room loudspeakers once the microphone goes to ON.

The opening of a microphone channel (if configured appropriately) can generate the closing command of the loudspeakers.

That is possible to choose one or more microphone to cut the loudspeaker output of the **Studio** by following this path:

SETUP / AUDIO / INPUTS / MIC / SPK-CUT (OFF, ST, CR, CR+ST)

When you select **ST**, if the configured Studio Mics are on the CUT indicator will blink as described by the following picture only on the OXYGEN REMOTER.

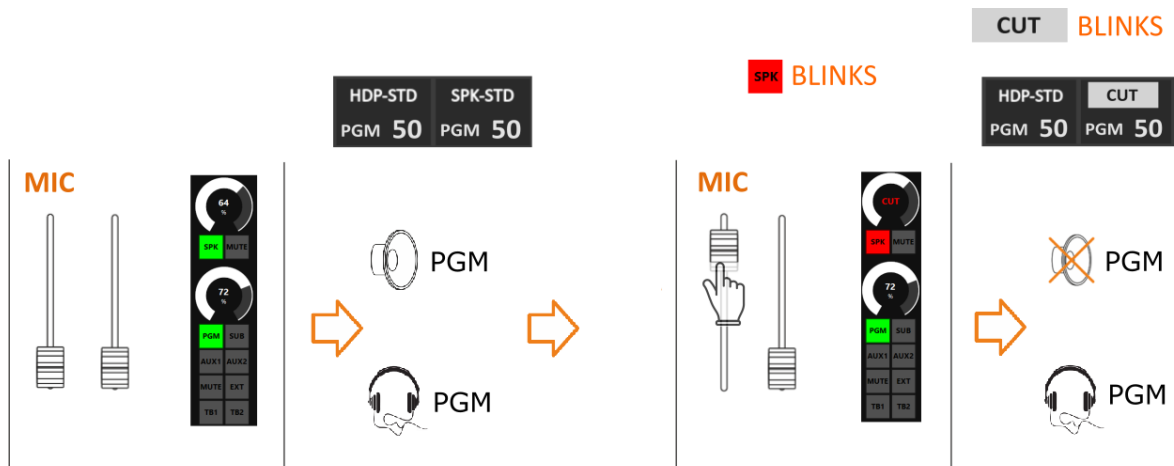

When you open the associated source with a **CUT** function you will see it will **MUTE** Studio Loudspeakers output to prevent LOOP audio and the SPEAKER icon on the OXYGEN REMOTER will start blinking.

ATT. (attenuation) MODE: It helps reduce acoustic flux from flowing into the speakers. It possible to decrease the speakers output -40, -30, -20 or -10 dB.

EX.: If we want to reduce the sound coming out of the speakers by **40 dB** less than the current value, then we have to choose **-40**. The same thing if we want to reduce the current volume when opening any of the microphones with a value of **10** decibels, then we have to choose **-10** and confirm the selection by pressing the button around until the selection color changes to yellow.

The **CUT** mode is triggered by the change from **OFF** to **ON** of a microphone source to which it has been set closing of the loudspeaker.

As shown in the MENU this function (**CUT**) is associated only with the loudspeakers, to avoid LARSEN effects "feedback loop" from occurring between the nearby loudspeakers and On-Air microphones.

On the other hand, if you need to **MUTE** the just **PRESS** the following button:

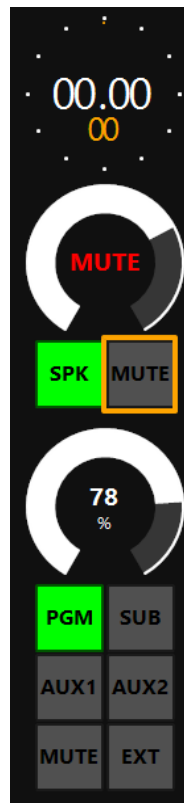

PRESS the MUTE button a second time to activate the loudspeakers output and amplification or attenuation.

The status of **MUTE-SPK** is indicated by the following alert:



and on the HDMI screen:



H. STUDIO HEADPHONES / MODE

SETUP / AUDIO / OUTPUTS / MONITOR / HEADPHONES / HDP-STUDIO / MODE

MODE: SEL, SEL+PFL

PFL (pre-fader listening): This mode allows you to listen in headphones to the audio of the PFL-channel **before** the intervention of the fader.

SEL (selection): This option allows you to listen in HDP-STUDIO the selected output from output section (PGM, SUB, EXT, AUX1, AUX2 only by Oxygen Remoter).

SEL+PFL (selection and pre-fader listening): This mode allows you to listen in HDP-STUDIO the selected output or **PFL** if the PFL button is pressed in a channel.

3.4 BLUETOOTH BUTTON

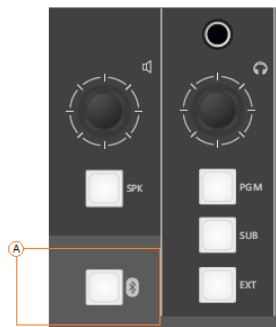

A. BLUETOOTH ACTIVATOR

The Bluetooth has two functioning ways:

- Microphone **TX**(Mono)- **RX**(Mono) Interface for telephone communication (GSM call, Skype, FaceTime, WhatsApp, Facebook, Etc.)
- **RX** (Stereo) interface for file/streaming player...

The device is in pairing mode after a fast press (< 1 sec) of the Bluetooth button. It starts to blink in blue color.



search for the **Oxygen 1000D-XXXX** if you have an Oxygen 1000 (or search for the **Oxygen 2000D-XXXX** if you have an Oxygen 2000) in Bluetooth device and connect with it. Once the device is connected the blue light stops blinking.



From OXYGEN REMOTER assign the Bluetooth audio source by selecting it into the desired drop-down menu (for example in 4th channel CH-A)





Press the desired BUS on the channel (in example PGM).



start the audio streaming (music, audio from YouTube/Music Player) or the phone call (Call, Skype, WhatsApp,) from the Bluetooth device.



With a long press of the Bluetooth button , you will disconnect the device.

If you turn on again the Bluetooth in the device and if the device is still associated with the console, it will be automatically paired. You will see a fixed blue light. The console is included **RN52 Bluetooth Audio Module**.

Note: For the module certifications, check this website please:

[HTTPS://WWW.MICROCHIP.COM/WWWPRODUCTS/EN/RN52](https://www.microchip.com/wwwproducts/en/RN52)

4. OXYGEN REMOTER - SETTINGS

4.1 OXYGEN REMOTER SIDE – ON BUTTON

ON button enables or disables the channel (ON/OFF:

- 1) **LED OFF** - OFF status
- 2) **LED ON** - ON status – the channel is OPEN.
- 3) **LED MUTE** in (MUTE color) – standby/MUTE status.

Differently, from the **EQ** and the **GAIN**, the **ON/OFF** status is not associated with the source, it's associated with the physical channel. It's unable to changing the sources between (**ChA/ChB**) if the channel status is **ON**.

The **ON/OFF** channel status could be changed by:

- pressing the **ON** button as shown below.

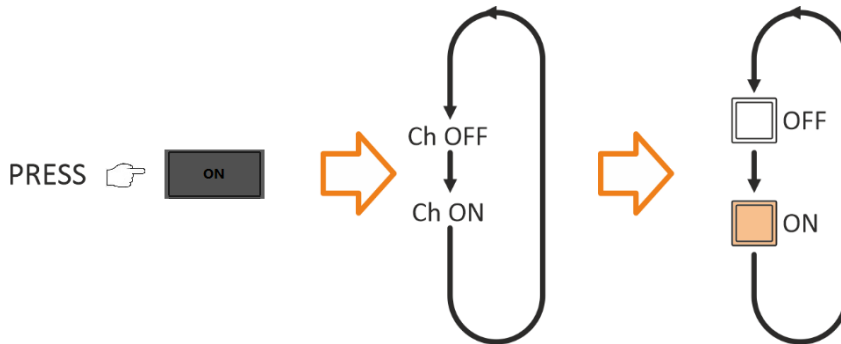

- The passage of the fader through a previously set threshold value in:
SETUP / AUDIO / SETTINGS / Fader threshold

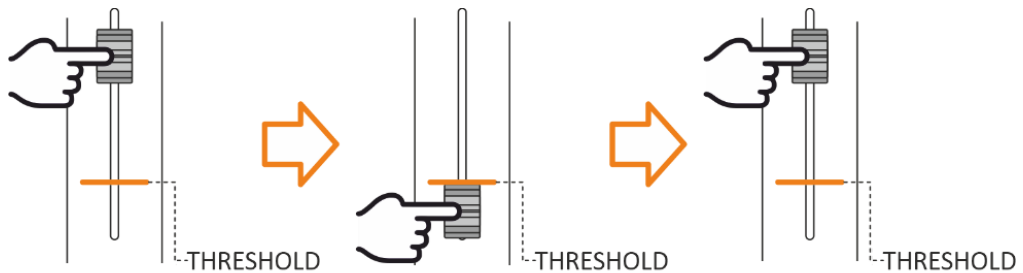

In the case of ON BY FADER active, it is possible to combine the FADER action with the OXYGEN REMOTER - ON button.

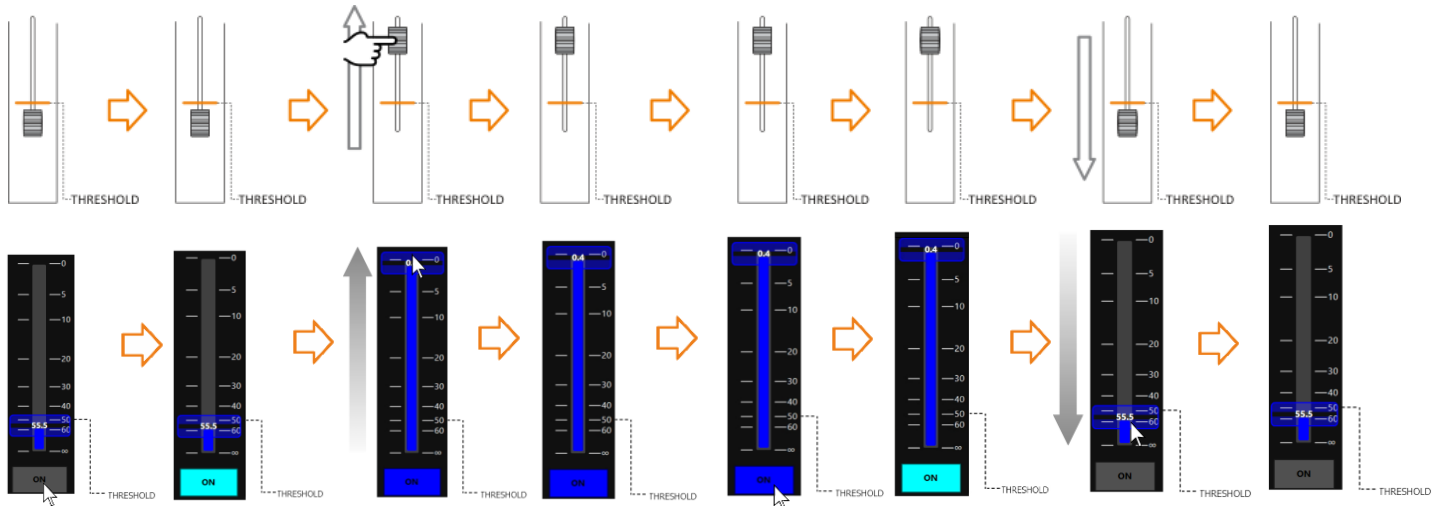
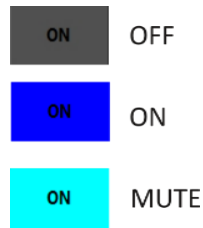

4.2 SPECIAL OXYGEN REMOTER FUNCTION BUTTONS

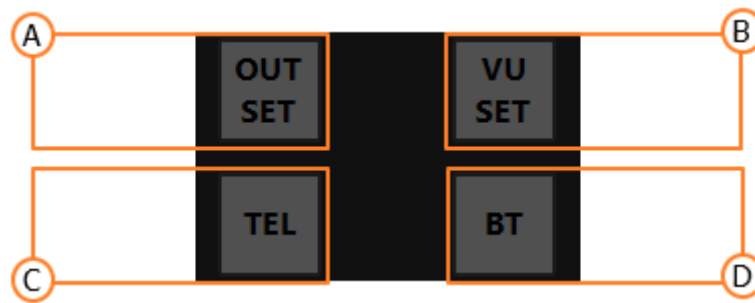

A. OUT SET

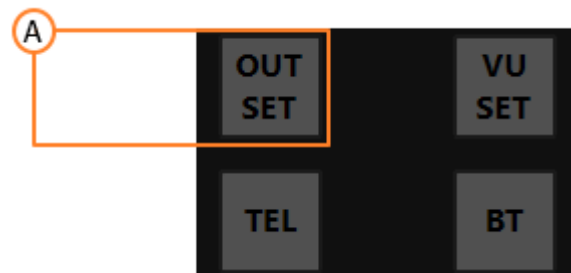

Inside the Oxygen Remoter button, the **OUTSET** button recalls directly the **OUTPUTS** configuration menu.

This button is a SHORTCUT to reach immediately the **SETUP / AUDIO / OUTPUTS** menu.

All the selectable OUTPUTS are described in following scheme:

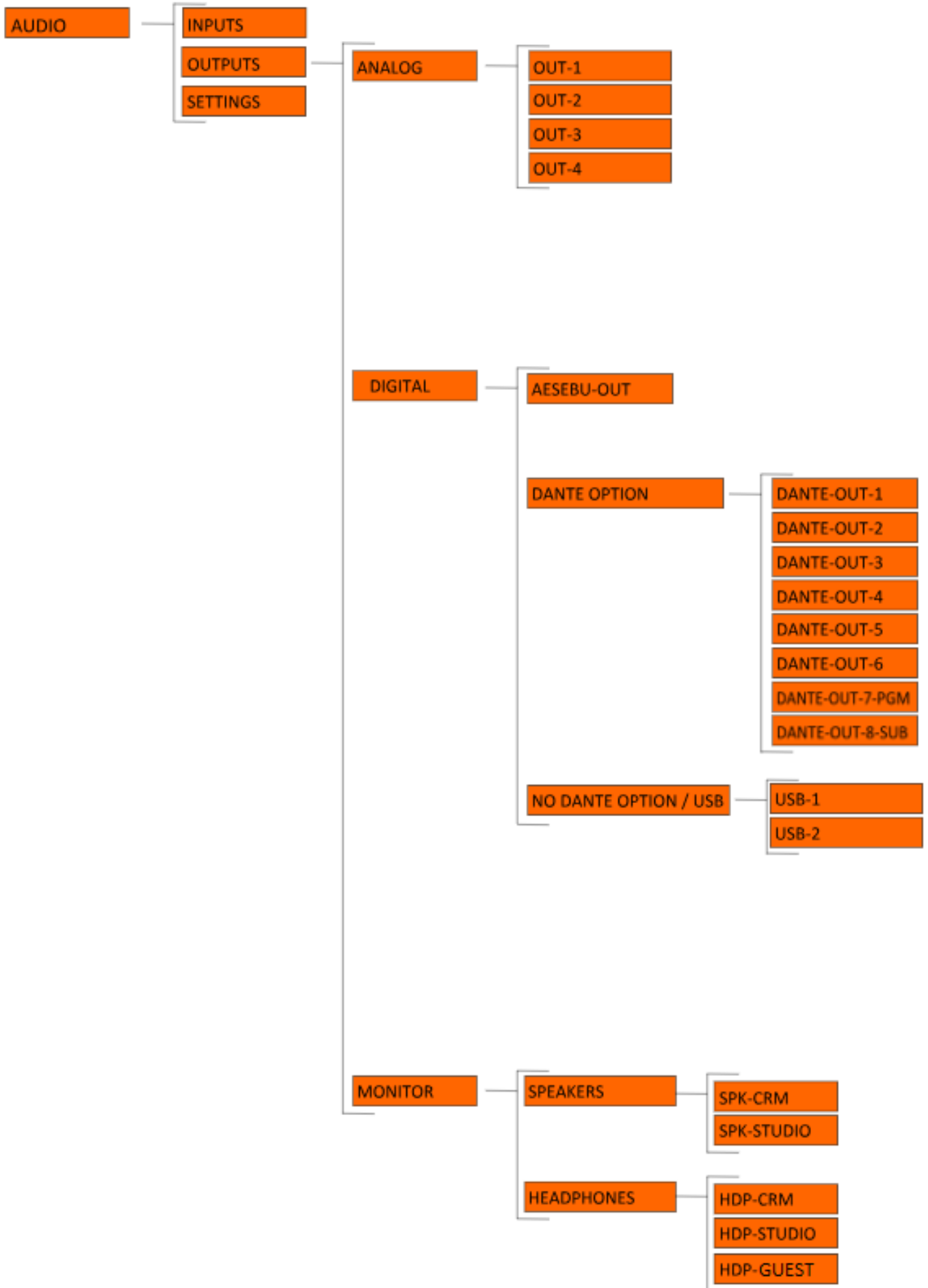

B. VU SET

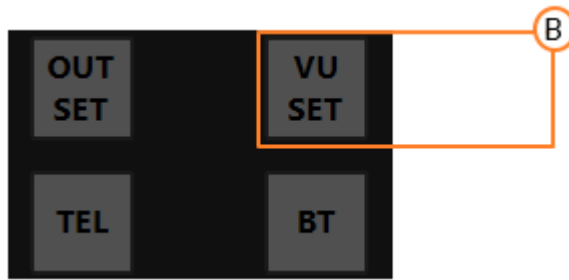

The **VU SET** button manages the source displayed in the OXYGEN REMOTER section of the LED METER screen.

By pressing **VU SET**, you can select the displayed **BUS**.

The repeated pressing of the **METER** button switches the 4 **BUS** and the MONITOR SELECTION, sequentially displaying them.

PFL -> SUB -> AUX-1 -> AUX-2 -> MONITOR SELECTION -> PFL -> SUB

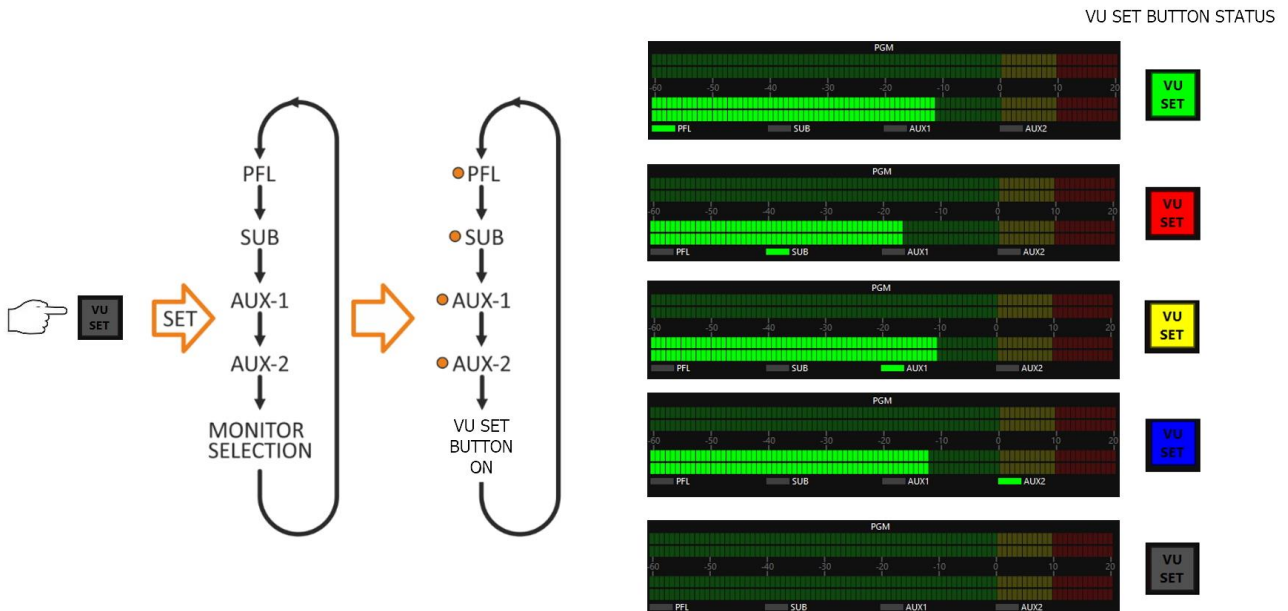

If one of the four LEDs is on (PFL/SUB/AUX-1/AUX-2) the selected **BUS** is forcibly displayed.

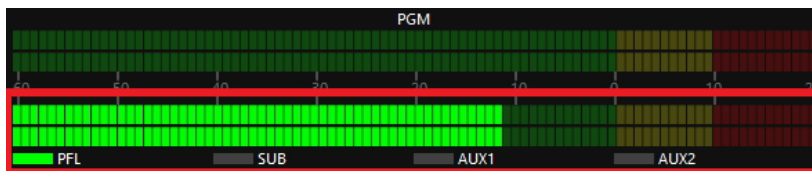

The selected source in **HDP C-ROOM** is being displayed in the MONITOR SELECTION status. In this case, all 4 LEDs are OFF as explained in the following picture.

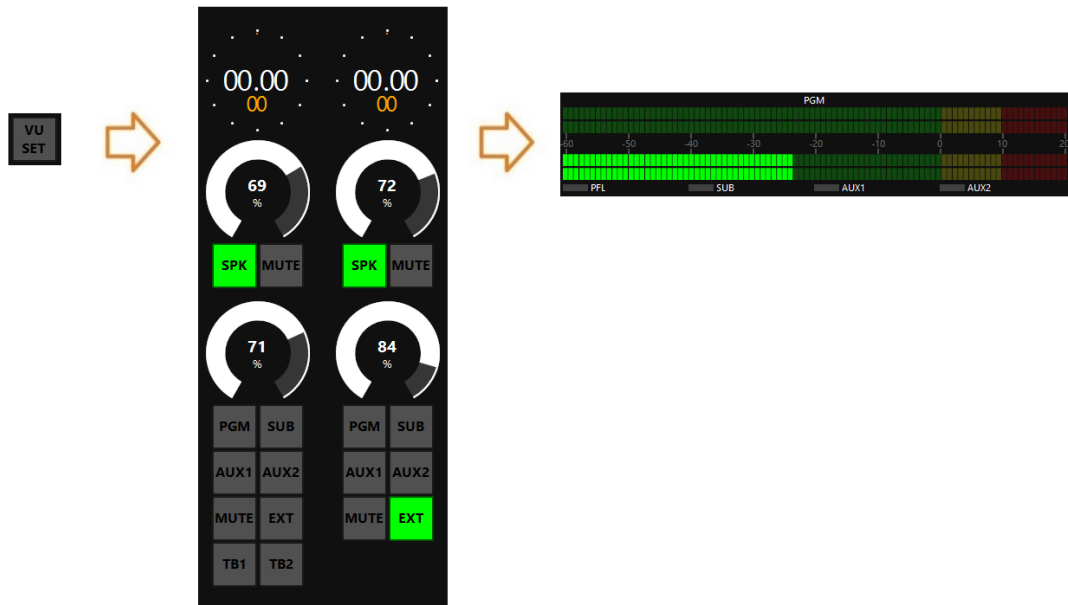

C. TELEPHONE (TEL – OXYGEN REMOTER SIDE)



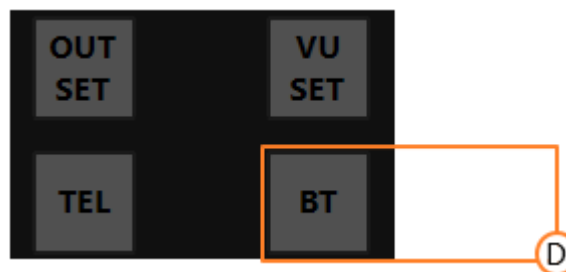

This button has the same functionality as the F1 button in telephone channel. It hooks up the incoming call for the telephone channel.

D. BLUETOOTH (BT – OXYGEN REMOTER SIDE)





The Bluetooth has two functioning ways:

- Microphone **TX**(Mono)- **RX**(Mono) Interface for telephone communication (GSM call, Skype, FaceTime, WhatsApp, Facebook, Etc.)
- **RX** (Stereo) interface for file/streaming player...

The device is in pairing mode after a fast press (< 1 sec) of the Bluetooth button  or after a fast pressure of the  button on Oxygen Remoter. It starts to blink in blue color.



search for the **Oxygen 1000D-XXXX** (in case of an Oxygen 1000) or **Oxygen 2000D-XXXX** (in case of an Oxygen 2000) in Bluetooth device and connect with it. Once the device is connected the blue light stops blinking . On the Oxygen Remoter you will see .



On the Oxygen Remoter, from the desired channel, in the drop-down source menu search for Bluetooth (for example for Channel 8).

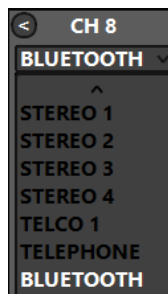

Press the desired BUS on the channel (in example PGM)

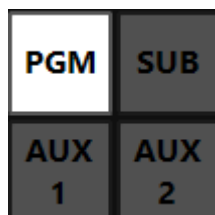

start the audio streaming (music, audio from YouTube/Music Player) or the phone call (Call, Skype, WhatsApp,) from the Bluetooth device.



With a long press of the console Bluetooth button  or with a simple pressure on the Oxygen Remoter Bluetooth button  you will disconnect the device.

If you turn on again the Bluetooth in the device and if the device is still associated with the console, it will be automatically paired. You will see a fixed blue light. The console is included **RN52 Bluetooth Audio Module**.

Note: For the module certifications, check this website please:

[HTTPS://WWW.MICROCHIP.COM/WWWPRODUCTS/EN/RN52](https://www.microchip.com/wwwproducts/en/RN52)

4.3 MONITORS SECTION

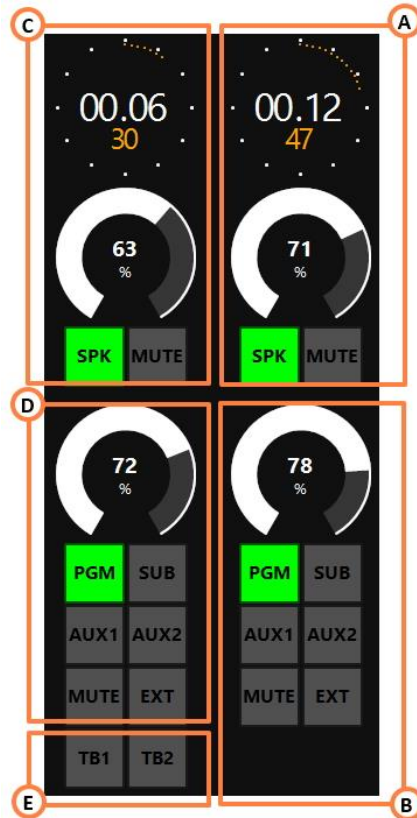

By Oxygen Remoter you can control 2 more logical AUDIO BUSS (AUX1, AUX2). Except for the OUT-1 (always assigned with the PGM logical AUDIO BUSS) you can define the additional AUX1 and AUX2 logical AUDIO BUSS as audio source of every available outputs of the menu:

SETUP / AUDIO / OUTPUTS



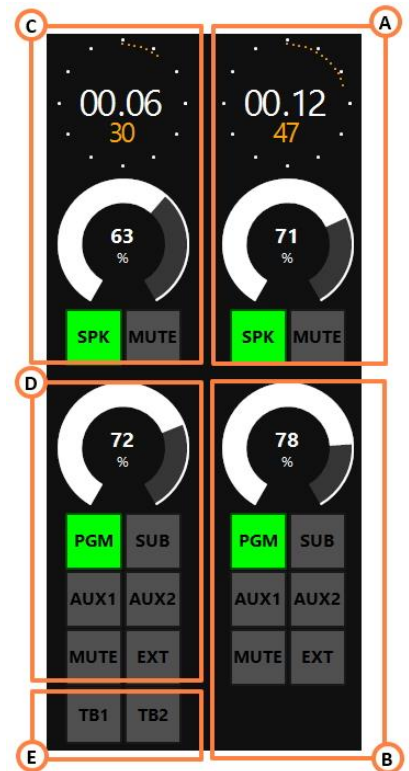
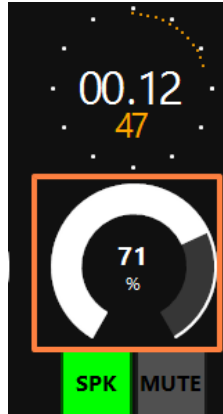

A. CONTROL ROOM SPEAKERS (SPK-CRM)

- This section is used for the management of the **CONTROL ROOM SPEAKERS** .
- By the mouse you can move the rotary control knobs to **amplify/attenuate** the audio level.



- The CRM-SPEAKERS audio level goes from **0 %** to **99 %** is the maximum allowed level. Can set the maximum level by going to this page:

SETUP / AUDIO / OUTPUTS / MONITOR / SPEAKER / SPK-CRM

- The step of the CRM-SPEAKERS adjustment is **1 dB** and the level goes from **-80 dB** to the maximum of **+19 dB**.
- By **pressing on MUTE**  you can  mute or unmute the **SPK-CRM** speakers if it is already muted.
- To unmute the speakers  just press  again or **increase/decrease** the audio level by rotating the related surface control and confirm that by clicking on the same knob.
- The Speaker's level is displayed in the bottom-right section of the HDMI display.



The status of **MUTE-SPK-CRM** is indicated by the following MUTE label on the bottom-right of the HDMI display:

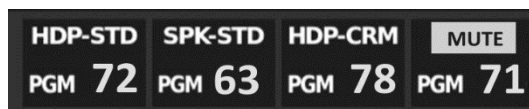

B. CONTROL ROOM HEADPHONES (HDP-CRM)

- This section is used for the management of the CONTROL ROOM HEADPHONES.
- The rotary control knobs allow you to **amplify/attenuate** the audio level.

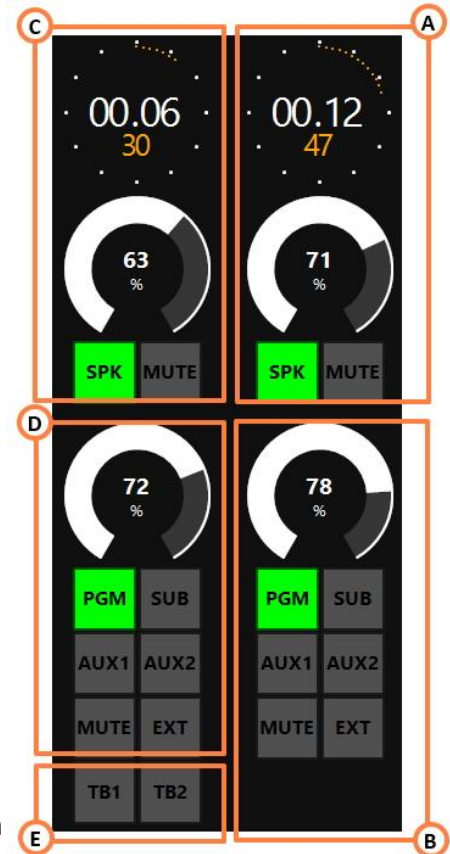
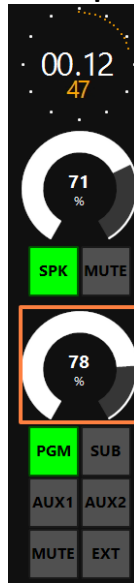

- The headphone audio level goes from **0 %** to **99 %** is the maximum allowed level. Can set the maximum level by going to this page: [SETUP / AUDIO / OUTPUTS / MONITOR / HEADPHONE / HDP-CRM](#)
- The step of the headphone adjustment is **1 dB** and the level goes from **-80 dB** to the maximum of **+19 dB**.

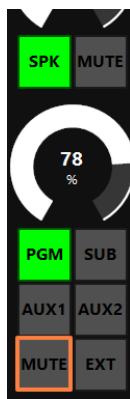

- By **pressing on** you can mute or play the HDP-CRM if it is already muted.

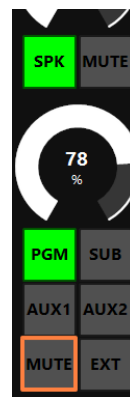

- To unmute the headphones just press again on or **increase/decrease** again the

audio level by rotating the related surface control and confirm that by clicking on the same knob.

- The Speaker's level is displayed in the bottom-right section of the HDMI display.



The status of MUTE-HDP-CRM is indicated by the following MUTE label on the bottom-right of the HDMI display:

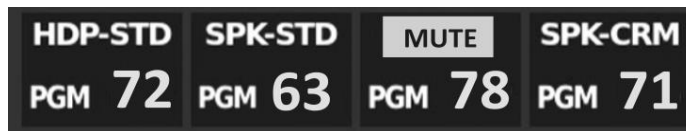

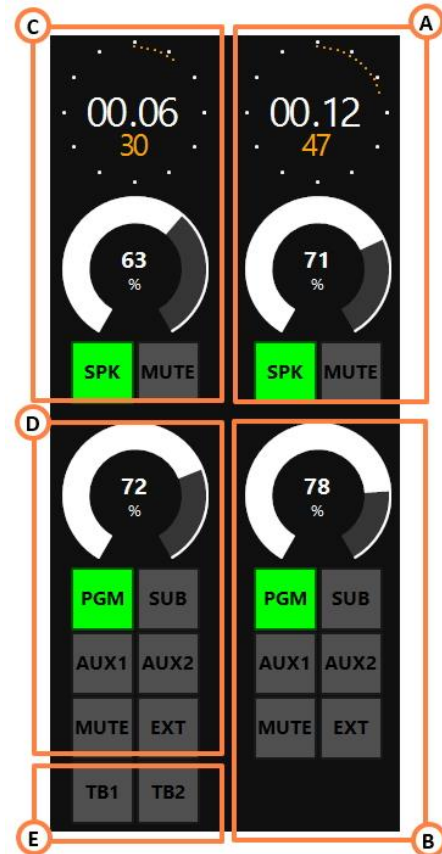
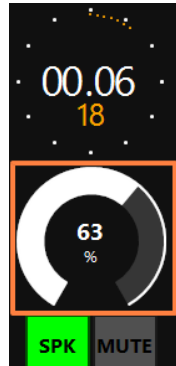

C. STUDIO SPEAKERS (SPK-STD)

- This section is used for the management of the **STUDIO SPEAKERS** .
- By the mouse you can move the rotary control knobs allow you to **amplify/attenuate** the audio level.



- The CRM-SPEAKERS audio level goes from **0 %** to **99 %** is the maximum allowed level. Can set the maximum level by going to this page:

SETUP / AUDIO / OUTPUTS / MONITOR / SPEAKER / SPK-STUDIO



- The step of the CRM-SPEAKERS adjustment is **1 dB** and the level goes from **-80 dB** to the maximum of **+19 dB**.
- By **pressing** on **MUTE** you can  mute or unmute the **SPK-STD** speakers if it is already muted.
- To unmute the speakers  just press **MUTE** again or **increase/decrease** the audio level by rotating the related surface control and confirm that by clicking on the same knob.
- The Speaker's level is displayed in the bottom-right section of the HDMI display.

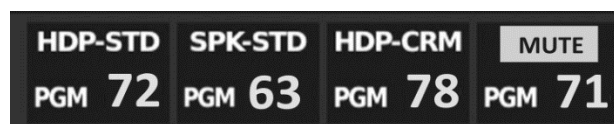

The status of **MUTE-SPK-CRM** is indicated by the following MUTE label on the bottom-right of the HDMI display:



D. STUDIO HEADPHONES (HDP-STD)

- This section is used for the management of the **HDP-STUDIO** headphones .
- The rotary control knobs allow you to **amplify/attenuate** the audio level.
- The headphone audio level goes from **0** to **99** is the maximum allowed level. Can set the maximum level by going to this page: **MENU / AUDIO / OUTPUTS / MONITOR / HEADPHONES / HDP-STUDIO**
- The step of the headphone adjustment is **1 dB** and the level goes from **-80 dB** to the maximum of **+19 dB**.
- By **pressing the knob**, you can mute  or play the **HDP-STUDIO** headphones if it is already muted.
- To unmute the headphone  just press their knob or **increase/decrease** the audio level by rotating the knob and confirm that by clicking on the same knob.
- The headphone level is displayed in the bottom-right section of the HDMI display.

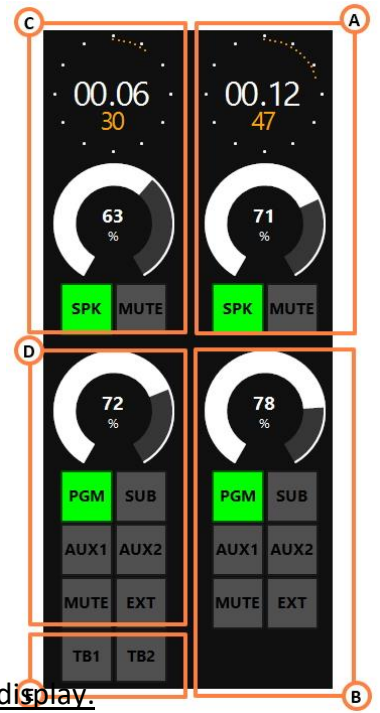

The status of **MUTE-HDP-STD** is indicated by the following MUTE label on the bottom-right of the HDMI display:

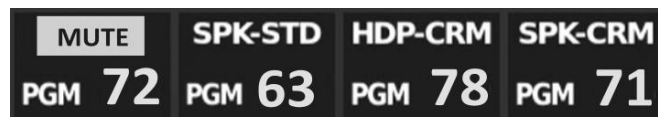

E. TALKBACK

SETUP / AUDIO / OUTPUTS / MONITOR / SPEAKER / SPK-CRM / TALK BACK (OFF, ON)

Here you can **disable/enable** the **TALKBACK** communications in control room speakers. Normally the talkback is used to communicate between the mixer man and the people in the studio via headphones or speakers or viceversa. This option gives you the possibility to hear the people talking in TALKBACK from the studio to the Control Room through Control Room speakers.

OFF: no talkback talks will be heard.

ON: talback talks will be heard.

SETUP / AUDIO / OUTPUTS / MONITOR / SPEAKER / SPK-STUDIO / TALK BACK (OFF, TB1, TB2, TB1+TB2)

Here you can **disable/enable** the **TALKBACK** communications in studio speakers. Normally the talkback is used to communicate between the mixer man and the people in the studio via headphones or speakers or viceversa. This option gives you the possibility to hear the people talking in TALKBACK from the Control Room to the STUDIO through Studio Speakers.

OFF: no talkback talks will be heard.

TB 1: Only talks directed to TB1 will be heard.

TB 2: Only talks directed to TB2 will be heard.

TB1+TB2: The talk messages directed to TB1 or TB2 will be both heard.

SETUP / AUDIO / OUTPUTS / MONITOR / SPEAKER / HPD-CRM / TALK BACK (OFF, ON)

Here you can **disable/enable** the **TALKBACK** communications in control room headphones. Normally the talkback is used to communicate between the mixer man and the people in the studio via headphones or speakers or viceversa. This option gives you the possibility to hear the people talking in TALKBACK from the studio to the Control Room through Control Room Headphones.

OFF: no talkback talks will be heard.

ON: talback talks will be heard.

SETUP / AUDIO / OUTPUTS / MONITOR / SPEAKER / HDP-STUDIO / TALK BACK (OFF, TB1, TB2, TB1+TB2)

Here you can **disable/enable** the **TALKBACK** communications in studio headphones. Normally the talkback is used to communicate between the mixer man and the people in the studio via headphones or speakers or viceversa. This option gives you the possibility to hear the people talking in TALKBACK from the Control Room to the STUDIO through Studio Headphones.

OFF: no talkback talks will be heard.

TB 1: Only talks directed to TB1 will be heard.

TB 2: Only talks directed to TB2 will be heard.

TB1+TB2: The talk messages directed to TB1 or TB2 will be both heard.

The following section is used for the management of the **TB** “TALKBACK” from the CONTROL ROOM to the Studio. By pressing **TB1** it's possible to speak with the anchorman in the STUDIO from the CONTROL ROOM.

HOLD IT DOWN

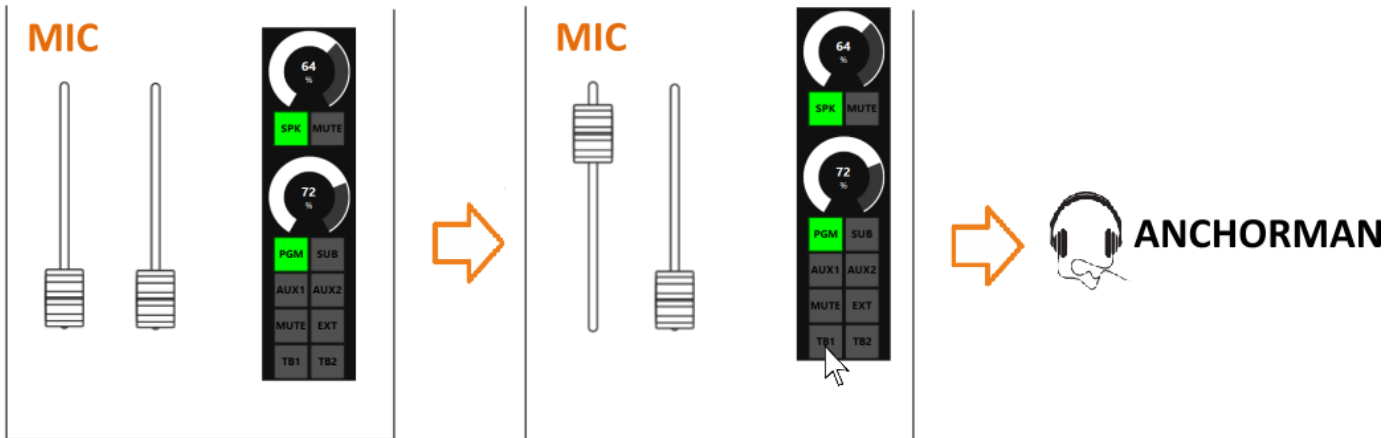

By pressing **TB2** it's possible to speak with the GUESTS in STUDIO.

HOLD IT DOWN

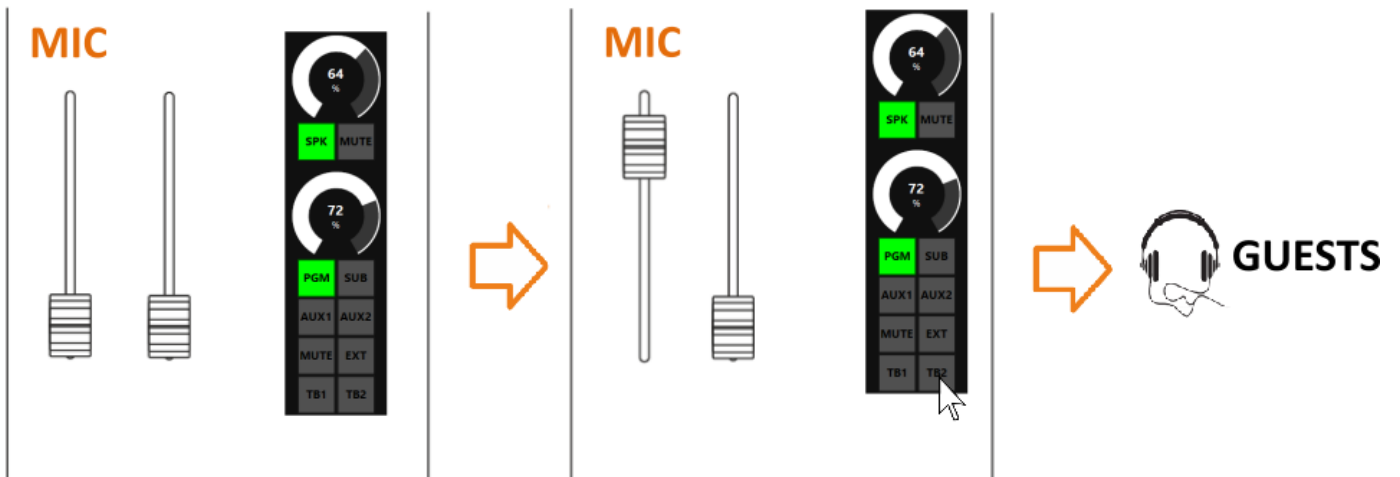

4.4 AUDIO

From this OXYGEN REMOTER section you can set all the INPUTS, OUTPUTS, CHANNELS, and SETTINGS parameters for all the console:

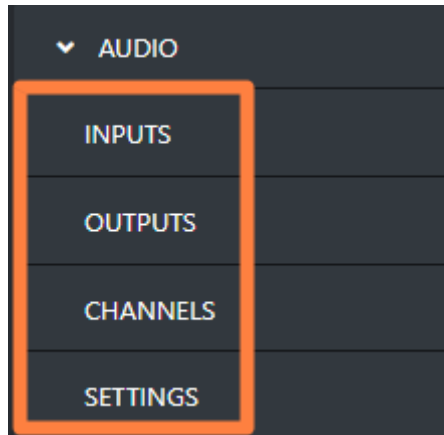

4.4.1 INPUTS

From this OXYGEN REMOTER subsection you can remotely manage all the console audio inputs. All the Sources are divided and grouped in the following categories:

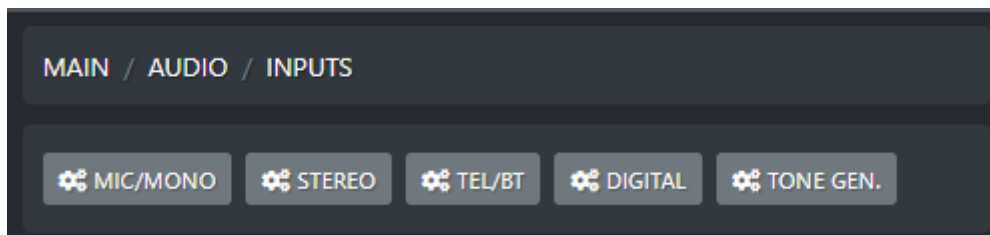

4.4.1.1 MIC/MONO

Inside the MIC/MONO subsection you will see all the available sources of the current MIC/MONO input category.

If you are using an external microphone amplifier, you can use one of the MONO sources.

The MONO sources will be the result of a split of the Left and the Right channels of a STEREO input.

This audio split has to be activated from the OXYGEN REMOTER:

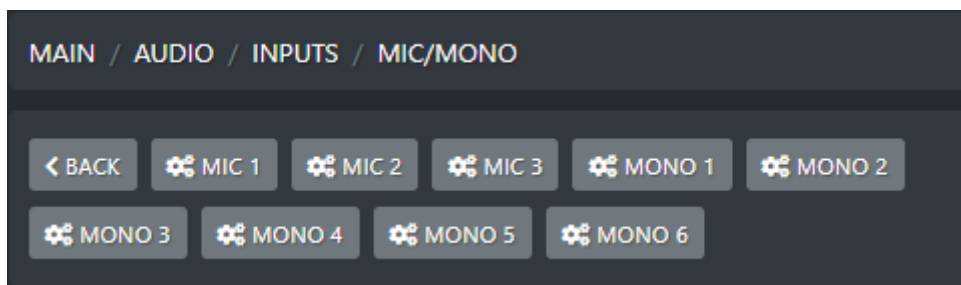

4.4.1.1.1 MIC (GENERAL)

PHANTOM 48V

This option allows you to turn **ON/OFF** the phantom power +48V to power up a condenser microphone:



PREAMP

The preamplifier is typically used to amplify microphone signals.

It allows you to amplify the weak signal of the microphone, in order to be routed toward a power amplifier or to loudspeakers without any noise or distortion.

This parameter changes the Input PREAMPLIFIER.

The parameter has a 3.0 dB step for a maximum of 57.0 dB.

Default value is 37.0 dB.



SPK-CUT

From this function, you can manage the **CUT** behaviour of the speakers in relation with the current microphone. By this section, you are able to assign the Speakers to be **CUT** (muted) on Microphone airing (**Control Room** Speakers or **STUDIO** Speakers).

It is possible to:

- disable the function at all
- select only one OUTPUT Monitor (**CR**, **ST**)
- select both OUTPUT Monitors (**CR+ST**).

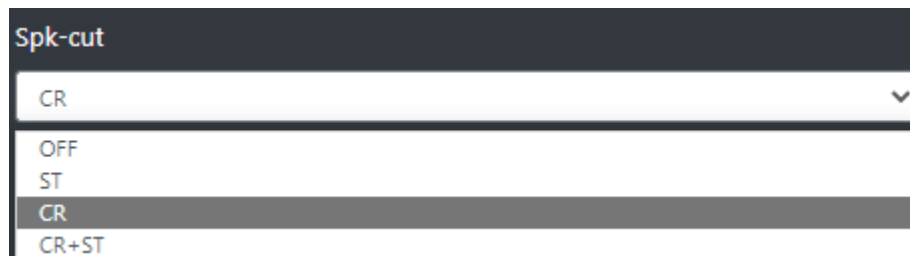

As shown in this MENU, this **SPK-CUT** function is associated only with the loudspeakers, to avoid LARSEN and “audio-feedbacks” from occurring between the nearby loudspeakers and On-Air microphones.

ONAIR LIGHT

This console allows you to connect the OnAir Lights by grouping them into 2 different group of lights:

- Control Room OnAir Lights
- Studio OnAir Lights

If the lights can be controlled by GPIO signals, these 2 groups of lights can be controlled by 2 different GPOs signals, generated by the Oxygen 1000 or OXYGEN 2000.

In this Microphone parameter you will be able to define if the Microphone lights up the Control Room OnAir Light, or if the Microphone lights up the Studio OnAir Light.

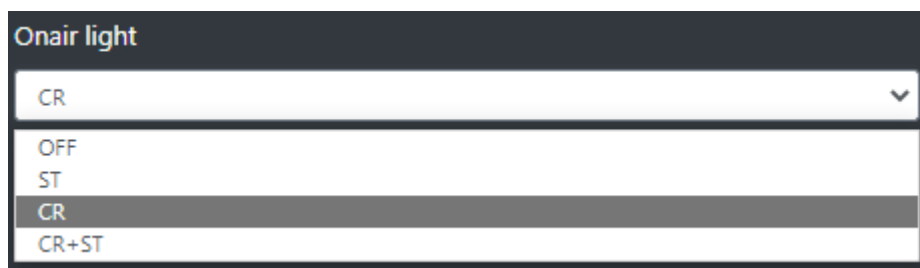

OFF: the airing of the current Microphone will not interact with any of your OnAir Lights.

ST: the airing of the current Microphone will lights up the Studio OnAir Lights.

CR: the airing of the current Microphone will lights up the Control Room OnAir Lights.

CR+ST: the airing of the current Microphone will lights up both the Studio and the Control Room OnAir Lights.

PRIVATE MIC

Before airing a current Phonenumber it is possible to talk privately to the caller.

By pressing PFL into the used phone channel (TELEPHONE, TELCO, BLUETOOTH), you will turn on the private communication.

Into this submenu you can decide if the current MIC has to be involved or not in this private communication OFFAIR.

Multi microphones can be defined as PRIVATE MICs.



No: the current MIC can not work as PRIVATE MIC

Yes: the current MIC can work as PRIVATE MIC

TB MIC

Axel Talkbox is an intercom box that allows the communication between people in the CONTROL ROOM and people in the STUDIO (for talkback operations).

So useful for the Program Director in Control Room to communicate OFFAIR with the speakers and guest in the Studio. This communication also works in the opposite direction, from speakers and guest in the Studio to the Program Director in Control Room.

Each Guest/Speaker Microphone and each Guest/Speaker Headphone is directly connected to a specific TalkBox.

From this menu you can decide the role of the current Microphone into this technical communication.



OFF: the current MIC won't work as TB MIC.

From CR to ST: the current MIC will work as a TB MIC. Its signal is the Program Director voice, it will be listened by Speakers and Guests. To use the MIC in this mode press TB1 or TB2 buttons at the bottom-right of the OXYGEN REMOTER home page.

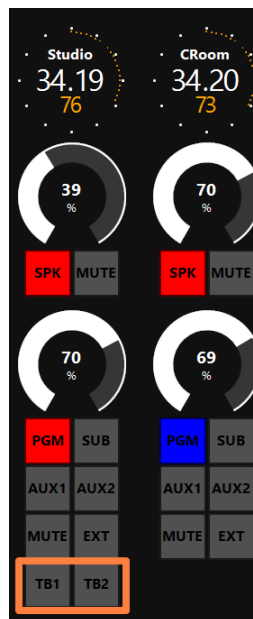

TB1 = STUDIO Talkbox

TB2 = GUEST Talkbox

From ST to CR: the current MIC will work as a TB MIC. Its signal is the Speaker/Guest voice, it will be listened by Program Director. To make the talkbak communication work, this current MIC has to be connected to the TALKBOX

F1 MODE

On each console channel you have one **F1** function button. It could be set to work in one of the following 4 modes. The user is free to select the preferred one.

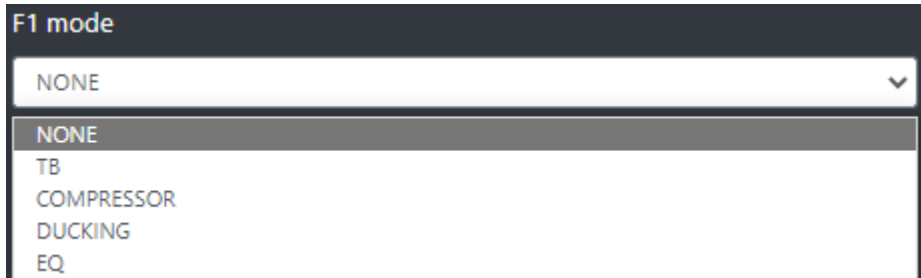

None: the F1 button of the channel to which this MIC source is assigned, is disabled.

TB: the F1 button of the channel to which this MIC source is assigned, lights up if the related STUDIO or GUEST microphone signal is talking in TalkBack mode. To work this mode you need to ensure you to have selected in the previous parameter the option **from ST to CR**.

Compressor: The F1 button of the channel to which this MIC source is assigned, will ENABLE or DISABLE the Compressor.

Ducking: The F1 in DUCKING MODE could be used in two different modes.

1. By applying a countinuitive pressure on F1 button of the channel to which this MIC source is assigned, will ENABLE the DUCKING. This will be activated if this MIC was set to be a Master Mic in the console DUCKING rules by the following window:

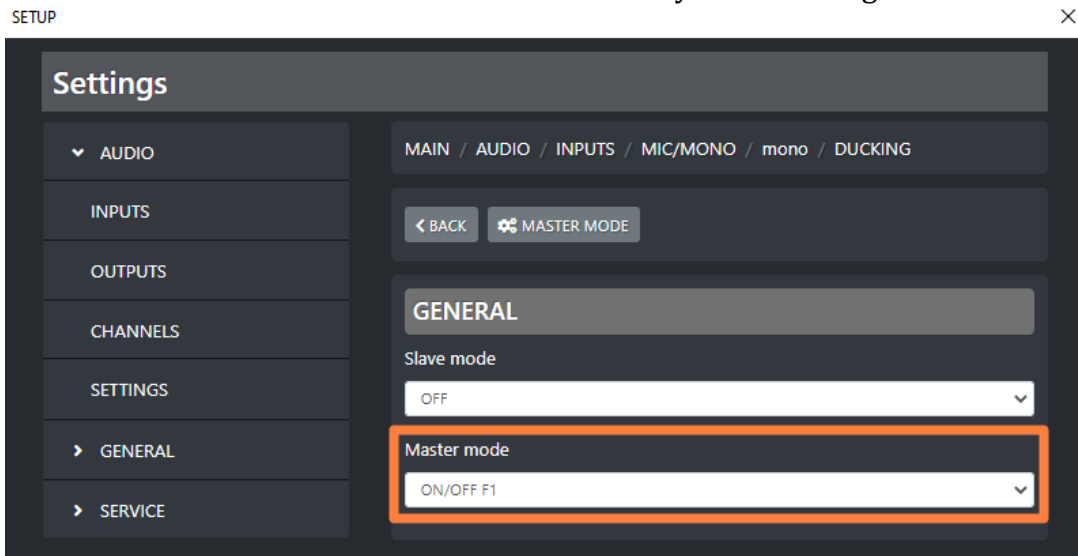

- If in the same parameter of the previous picture the Master Mode was set as follow:

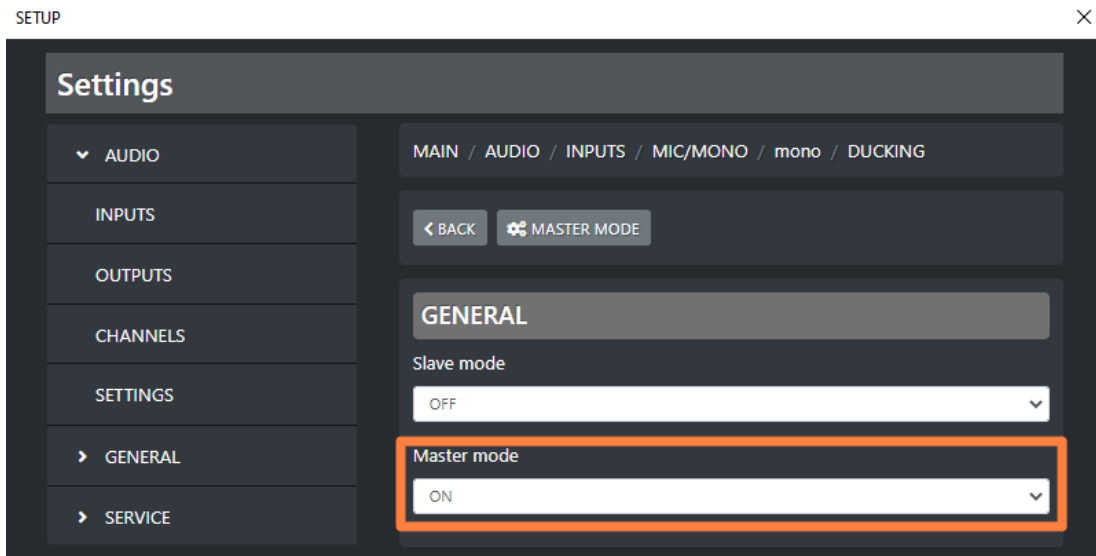

The F1 button to which this MIC source is assigned, starts blinking while its DUCKING is currently operating as MASTER.

Eq: The F1 button of the channel in which this MIC source is assigned to, will ENABLE or DISABLE the equalizer.

CUSTOM NAME



Type in this field a desired customized name for this microphone.

This will allow the director of the program to faster identify this microphone.

On your OXYGEN REMOTER the name of the channel will be displayed on the top of this mic channel:

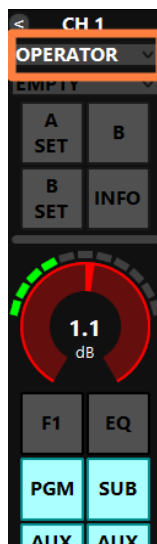

GAIN



This GAIN cursor adjusts the second GAIN of this MIC source. The first one is the PREAMP one. The same parameter could be modified directly from the related OXYGEN REMOTER channel:



The parameter has a 0.1 dB step for a minimum of -20.0 dB to a maximum of 20.0 dB. Default value is 0.0 dB

BAL/PAN



This control works as a panpot adjuster, it allows you to control the sound spaciality from left to right.

The parameter has a 0.5 step for a maximum minimum of -12.0 to a maximum of 12.0. Default value is 0

AUX-1

This submenu could be used to specify the behaviour of the current audio source in relation with the logical output AUX-1.



PRE FADER: The fader movement of the channel does not affect the AUX-1 logical output signal.

POST FADER: The fader movement of the channel affects the AUX-1 logical output signal.

PRE FADER ALWAYS ON: The fader movement of the channel does not affect the AUX-1 logical output signal and the source is always forwarded to the AUX-1 logical output, bypassing the ON button of the channel

AUX-2

This submenu could be used to specify the behaviour of the current audio source in relation with the logical output AUX-1.

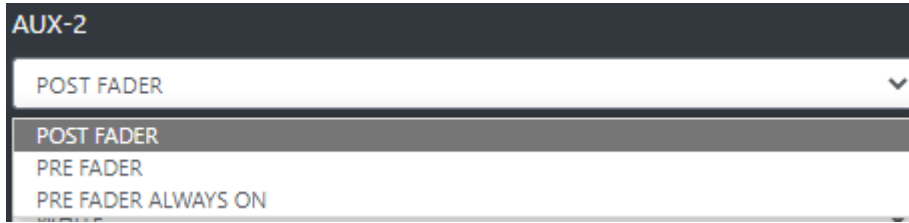

PRE FADER: The fader movement of the channel does not affect the AUX-2 logical output signal.

POST FADER: The fader movement of the channel affects the AUX-2 logical output signal.

PRE FADER ALWAYS ON: The fader movement of the channel does not affect the AUX-2 logical output signal and the source is always forwarded to the AUX-2 logical output, bypassing the ON button of the channel

BUTTON LIGHT



Between available colors, select the one to be assigned to the following channel buttons:

F1, EQ, PGM, SUB, AUX1, AUX2

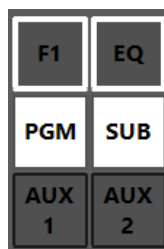

ON



The selection affects all the channels to which this audio source is assigned.

To modify the customizable COLOR 1, COLOR 2, COLOR 3, COLOR 4, go in the menu:

SETUP / GENERAL / LIGHT&DISPLAY

FADER BAR LIGHT

Between available colors, select the one to be assigned to the following channel controls:

ON led, GAIN adjustment

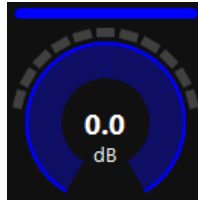

FADER BAR, FADER SLIDER

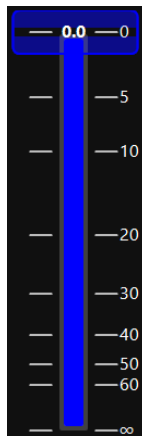

PHASE

The PHASE controller allows you to flip the phase of the signal wave with a rotation of 180°. The rotation of the phase allows you to avoid the phase cancellation due to destructive interferences with a different signals.

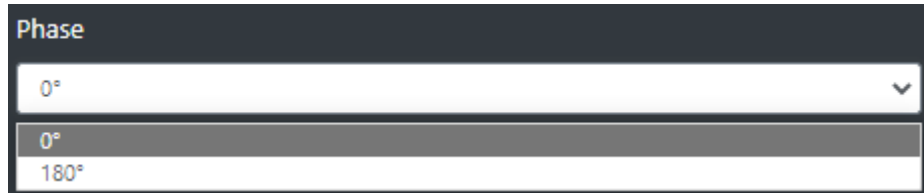

0°: the selection of this option will keep the original signal phase

180°: the selection of this option will apply a phase flipping (horizontal axial symmetry) of 180°.

ON MODULE



BY BUTTON & FADER: The airing of the channel needs an interaction of the ON button and a slide up of the fader.

The channel to be considered ON has to be into the following status:

ON = active

SLIDER = higher than $-\infty$

BY FADER: The airing of the channel needs only a slide up of the fader. The OFF status of the channel could only be reached by sliding down the fader and not by ON button pressure.

The channel to be considered ON has to be into the following status:

SLIDER = higher than $-\infty$

BY BUTTON: The airing of the channel needs only an interaction with the ON button:

The channel to be considered ON has to be into the following status:

ON = active

The slider movements will not affect the ON/OFF status of the channel.

ALWAYS ON: The channel is always considered ON. The sliding down of the fader never put the channel in OFF status.

ALWAYS OFF: The channel is always considered OFF.

4.4.1.1.2 MIC (EQ)

LOW CUT

Low cut (or High Pass filter) is designed to remove all the audio frequencies below the decided one.



Enable: Enable/Disable the application of this Low Cut filter on the audio signal of the current source.

Frequency: All the frequencies below the selected one will be cut off.

BASS / BASS MID / MID / MID HIGH / HIGH

In OXYGEN 1000 and OXYGEN 2000 the equalizer allows a multi-band adjustment of the EQ parameters.

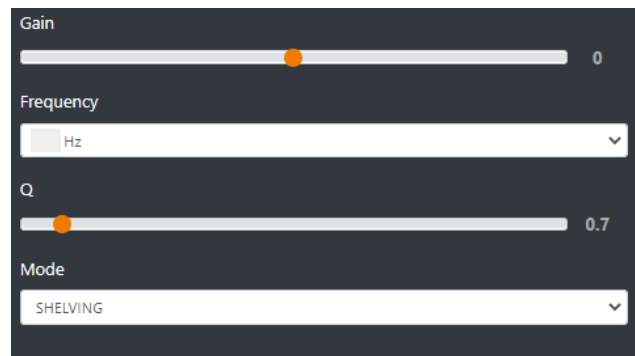

Above the involved parameters to manage: AMPLITUDE, CENTER FREQUENCY, and BANDWIDTH.

GAIN slider controls the amplitude of each band.

FREQUENCY sub-menu can shift and select the central frequency.

Q slider is inversely related to the Bandwidth (which is inversely related to "Q"), Q allows the Bandwidth to be widened or narrowed.

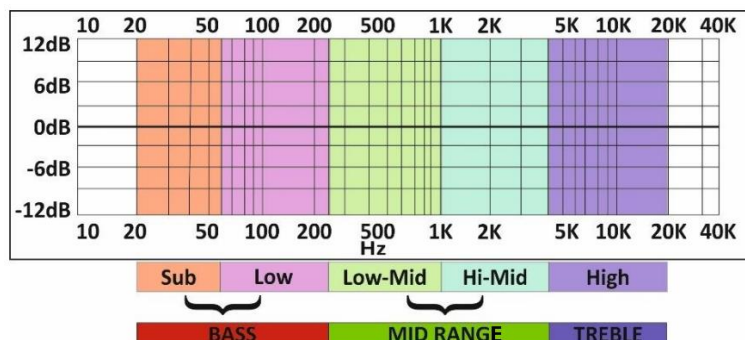

MODE only works in SHELIVING mode for BASS and HIGH (not for BASS-MID, MIDDLE and MID HIGH).

Peak is related to a specific center frequency choosable by FREQUENCY, Q will be applied on the left and on the right of the choosen FREQ. it has to be chosen the center frequency and by the Q factor you can decide to enlarge or to restrict the application curve of the decided gain.

Shelving applies the GAIN on the frequencies before the choosen FREQ (for BASS) and on the frequencies after the choosen FREQ (for HIGH) . The Q factor represents the decreasing slope to be applied from the maximum to the minimum point.

HIGH CUT

High Cut (or Low Pass filter) is designed to remove all the audio frequencies above the selected one.



Enable: Enable/Disable the application of this High Cut filter on the audio signal of the current source.

Frequency: All the frequencies below the selected one will be cut off.

GENERAL MODE

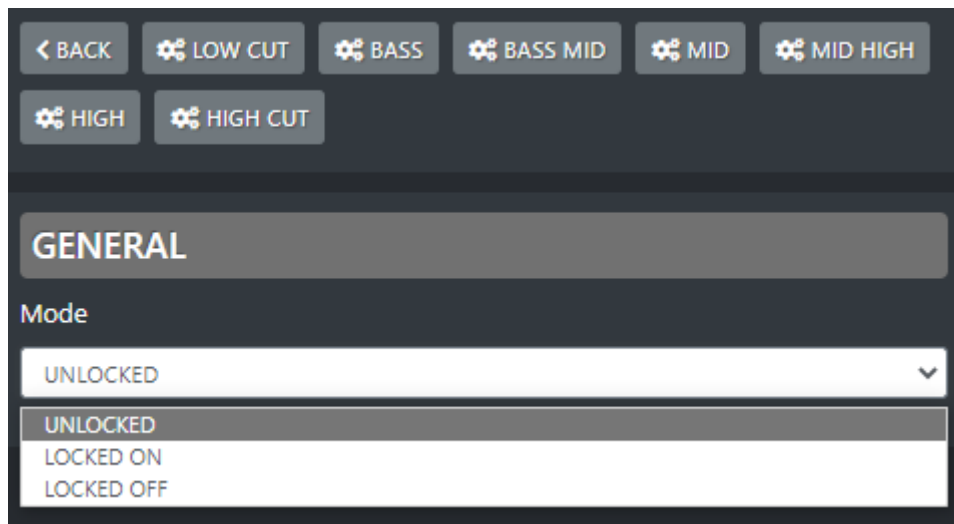

UNLOCKED: This mode always allows to enable/disable EQ by the presure of the related EQ button of the channel.

LOCKED ON: This mode forces the related EQ button of the channel always ON

LOCKED OFF: This mode forces the related EQ button of the channel always OFF

4.4.1.1.3 MIC (COMPRESSOR)

Dynamic range compression (**DRC**) or simply compression is an audio signal processing operation that reduces the volume of loud sounds or amplifies quiet sounds thus reducing or compressing audio signals in **DYNAMIC RANGE**. Compression is commonly used in sound recording and reproduction, broadcasting, live sound reinforcement, and some instrument amplifiers.

EXPANDER

The dynamic settings need to be defined by starting with the **EXPANDER THRESHOLD** parameter definition.

The suggested value for the **EXPANDER THRESHOLD** is **-50 dB**.

- The signal lower than this value will be gated and will not be considered.
- The signal higher than this value will be expanded according to the **EXPANDER RATIO**.
Highing up the **RATIO** too much will high up a bit also the background noise.

COMPRESSOR and **LIMITER** will only act on the considered values, the once higher than the current **EXPANDER THRESHOLD**.

COMPRESSOR

The **COMPRESSOR THRESHOLD** defines a maximum dB value at which all the considered signal must be kept. The signals that exceed this threshold must be reduced in accordance with the **COMPRESSOR RATIO**. The speed of action of this reduction is not immediate, but is adjustable by the **COMPRESSOR RATIO**. its purpose is to pump up the sound, reducing its general dynamics.

The suggested value for the **COMPRESSOR THRESHOLD** is between **-6 dB < C. THRESHOLD < -2 dB**.

- The signal lower than this value will be kept inaltered.
- The signal higher than this will be reduced according to the **COMPRESSOR RATIO**.

LIMITER

The **LIMITER THRESHOLD** acts as a fast signal reduction. The action of the **LIMITER** is much faster and harder, unlike the slower and softer action of the compressor. The suggested value for **the LIMITER THRESHOLD** is **6 dB**.

- The signal lower than this value will be kept inaltered.
- The signal higher than this value will be cut out in real time.

The **LIMITER RATIO** parameter is useless, because the action will take instantaneously all the signals higher than **LIMITER TRESHOLD** to the same set **LIMITER THRESHOLD**.

4.4.1.1.4 MIC (DUCKING)

The DUCKING system allows you to automatically lower the signals of the music while the speakers talk to their MICROPHONES. For this reason, OXYGEN 1000 and OXYGEN 2000 have been designed with a very useful DUCKING function, which fulfills this need.

In the musical programs when it is mixed with a speech that needs drop music when the anchorman or the guest starts speaking. the background music instantly drops, then it pops right back up again as soon as that person finishes talking. This happens when the ducking effect in action.

Ducking temporarily lowers, or “ducks,” the volume level of a specified audio signal anytime a second specified audio signal is present. In live sound, ducking is commonly used to lower background music anytime a person speaks, then raises it when that person finishes speaking

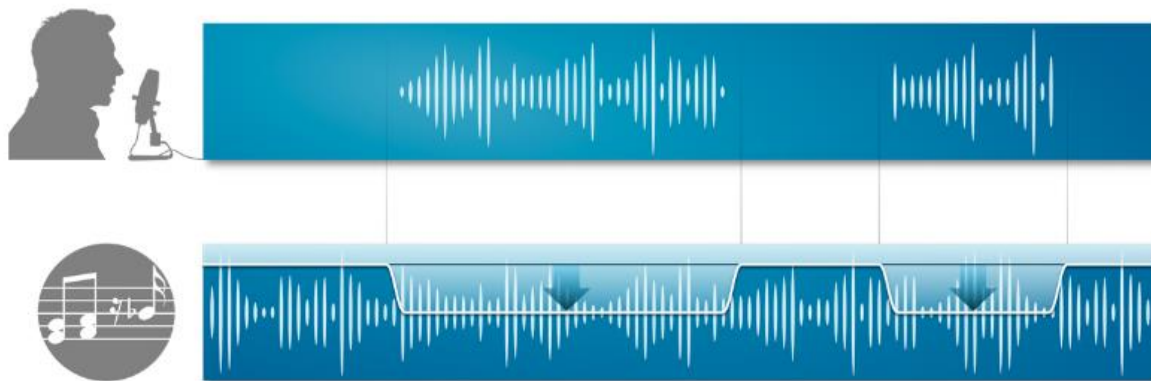

MASTER & SLAVE is the logic on which this functionality is based.

Each console source can be defined as a MASTER source or a SLAVE source.

Usually broadcast microphones are defined as MASTER microphones and other sources in which there is music are defined as SLAVE.

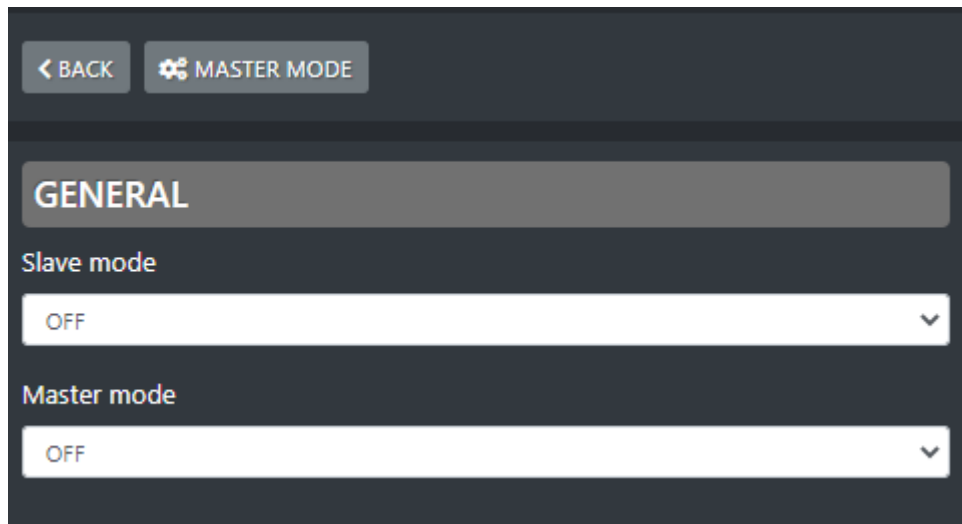
**SLAVE MODE:**

OFF - in this case the current source will never be lowered when any MASTER source is on air.

ON - in this case the current source will be lowered in level, whenever a MASTER source is on air.

MASTER MODE:

OFF - in this case the current source is not selected as the MASTER source. When it is on air, the sources set as SLAVE sources will not be lowered.

ON - in this case the current source is selected as the MASTER source. When it is on air, the sources set as SLAVE sources will automatically be lowered.

ON/OFF F1: The selected MIC source works in MASTER MODE only if you press the F1 button of the related channel.

If MASTRER MODE=ON press

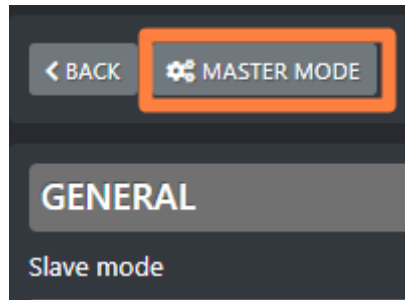

to enter its configuration panel where it will be possible to decide the behavior of all the SLAVE sources, when this MASTER is onair:

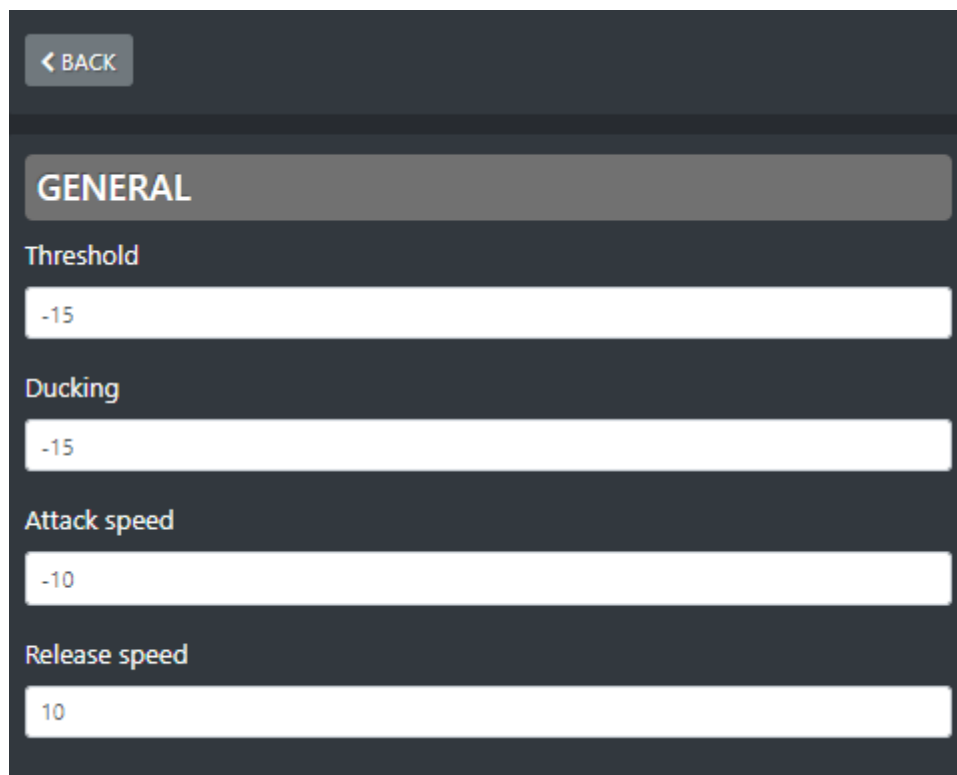

Threshold: minimum audio threshold (dB) relative to this same source. When this audio source reaches this minimum threshold level, DUCKING will be activated for the lowering of all the other sources set as SLAVE.

Ducking: lowering (in dB) performed on all SLAVE sources.

Attack speed: DUCKING activation speed of the current source when its DUCKING activates.

Release speed: speed at which the DUCKING of the current source is deactivated when the same source stops to be on air.

4.4.1.2.1 MONO (GENERAL)

The mono sources are only available in the case of LINE INPUTS were set as 2 MONO modes:

ANALOG-IN-1 input can be transformed into 2 MONO independent inputs by:

SETUP / AUDIO / SETTINGS / INPUT MODE / LINE 1 mode = 2 MONO

MONO 1 (LINE-1-L)

MONO 2 (LINE-1-R)

ANALOG-IN-2 input can be transformed into 2 MONO independent inputs by:

SETUP / AUDIO / SETTINGS / INPUT MODE / LINE 2 mode = 2 MONO

MONO 3 (LINE-2-L)

MONO 4 (LINE-2-R)

ANALOG-IN-3 input can be transformed into 2 MONO independent inputs by:

SETUP / AUDIO / SETTINGS / INPUT MODE / LINE 3 mode = 2 MONO

MONO 5 (LINE-3-L)

MONO 6 (LINE-3-R)

Based on these 3 previous settings you can have or 0 or 2 or 4 or 6 available MONO channels.

SPK-CUT

The SPK CUT is useful in the case you have added to 1 MONO line an output of an external microphone amplifier.

From this function, you can manage the **CUT** behaviour of the speakers in relation with the current MONO input. By this section, you are able to assign the Speakers to be **CUT** (muted) on MONO airing (**Control Room** Speakers or **STUDIO** Speakers).

It is possible to:

- disable the function at all
- select only one OUTPUT Monitor (**CR**, **ST**)
- select both OUTPUT Monitors (**CR+ST**).



As shown in this MENU, this **SPK-CUT** function is associated only with the loudspeakers, to avoid LARSEN and “audio-feedbacks” from occurring between the nearby loudspeakers and On-Air additional microphones connected to MONO inputs.

ONAIR LIGHT

This console allows you to connect the OnAir Lights by grouping them into 2 different group of lights:

- Control Room OnAir Lights
- Studio OnAir Lights

If the lights can be controlled by GPIO signals, these 2 groups of lights can be controlled by 2 different GPOs signals, generated by the Oxygen 1000 or Oxygen 2000.

In this MONO parameter you will be able to define if the MONO, lights up the Control Room OnAir Light, or if the MONO, lights up the Studio OnAir Light.



OFF: the airing of the current signal will not interact with any of your OnAir Lights.

ST: the airing of the current signal will lights up the Studio OnAir Lights.

CR: the airing of the current signal will lights up the Control Room OnAir Lights.

CR+ST: the airing of the current signal will lights up both the Studio and the Control Room OnAir Lights.

PRIVATE MIC

Before airing a current Phonecall it is possible to talk privately to the caller.

By pressing PFL into the used phone channel (TELEPHONE, TELCO, BLUETOOTH), you will turn on the private communication.

Into this submenu you can decide if the current MONO channel (if a MIC is plugged) has to be involved or not in this private communication OFFAIR.

Multi microphones can be defined as PRIVATE MICs.



No: the current MONO can not work as PRIVATE MIC

Yes: the current MONO can work as PRIVATE MIC

TB MIC

Only in the case you are using this MONO source as a MIC source, with the support of an external amplification device, you can use this MIC with a TB operability only in the mode **TB mic = from CR to ST**.

So useful for the Program Director in Control Room to communicate OFFAIR with the speakers and guest in the Studio.

From this menu select:



OFF: the current MONO input won't work as TB MIC.

From CR to ST: the current MONO input will work as a TB MIC. Its signal usually is the Program Director voice, it will be listened by Speakers and Guests. To use this MONO in this mode press TB1 or TB2 buttons at the bottom-right of the OXYGEN REMOTER home page.

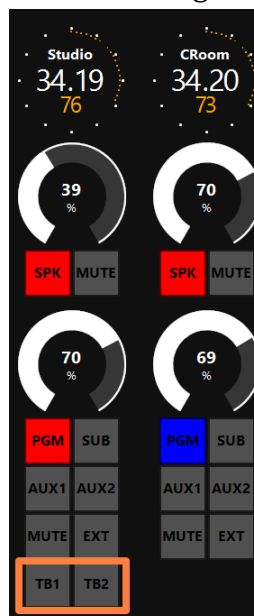

TB1 = STUDIO Talkbox

TB2 = GUEST Talkbox

From ST to CR: This mode only works with a MIC directly connected to an external AXEL TALKBOX (with GPIO-relays function). With this MONO source could not be used.

F1 MODE

On each console channel you have one **F1** function button. It could be set to work in one of the following 4 modes. The user is free to select the preferred one.

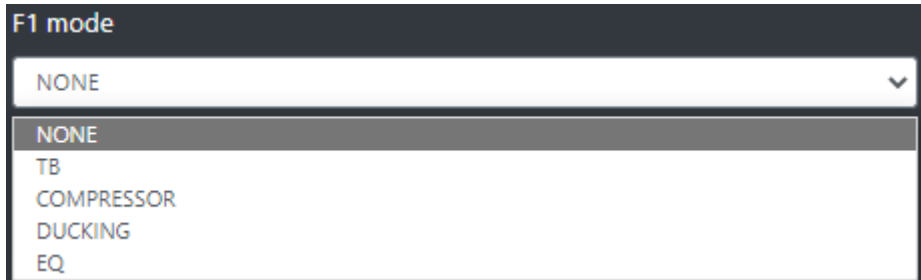

None: the F1 button of the channel to which this MONO source is assigned, is disabled.

TB: the F1 button of the channel to which this MONO source is assigned, blinks if the related STUDIO or GUEST microphone signal is talking in TalkBack mode. To work this mode you need to ensure you to have selected in the previous parameter the option **from ST to CR**.

Compressor: The F1 button of the channel to which this MONO source is assigned, will ENABLE or DISABLE the Compressor.

Ducking: The F1 in DUCKING MODE could be used in two different modes.

1. By applying a countinulative pressure on F1 button of the channel to which this MONO source is assigned, will ENABLE the DUCKING. This will be activated if this MONO was set to be a Master Mic in the console DUCKING rules by the following window:

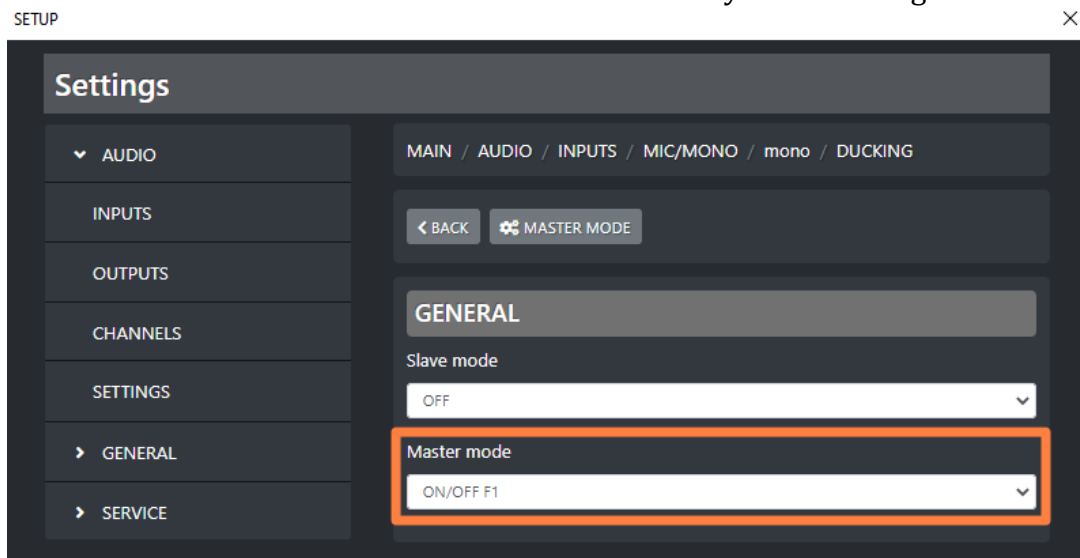

2. If in the same parameter of the previous picture the Master Mode was set as follow:

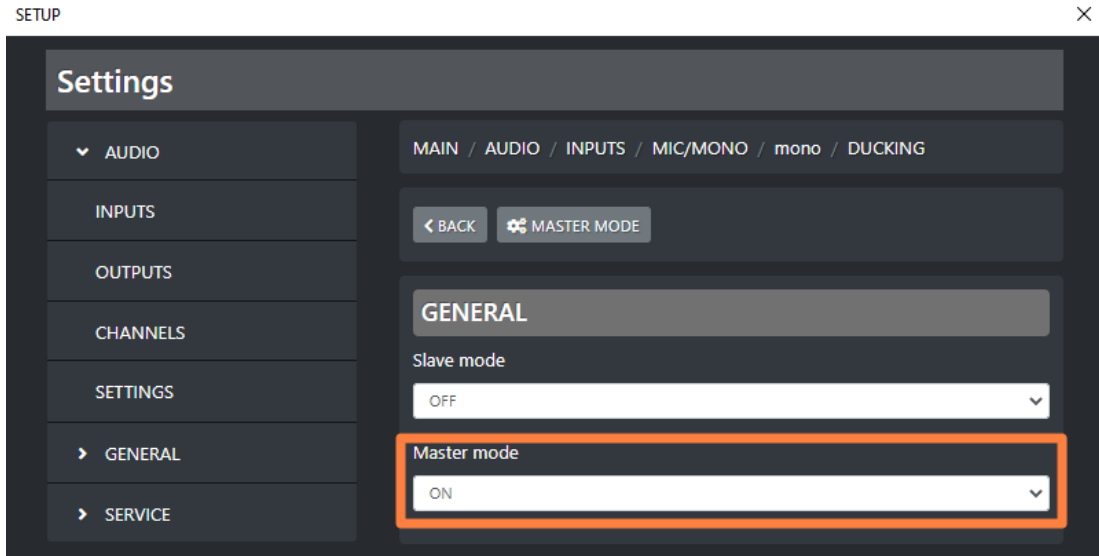

The F1 button to which this MONO source is assigned, starts blinking while its DUCKING is currently operating as MASTER .

Eq: The F1 button of the channel in which this MONO source is assigned to, will ENABLE or DISABLE the equalizer.

CUSTOM NAME



Type in this field a desired customized name for this mono source. This will allow the director of the program to faster identify this mono source.

On your OXYGEN REMOTER the name of the channel will be displayed on the top of this mono channel:

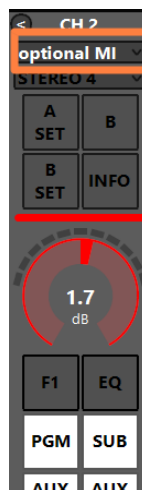

GAIN



This cursor adjusts the MONO source GAIN.

The same parameter could be modified directly from the related OXYGEN REMOTER channel:



The parameter has a 0.1 dB step for a minimum of -20.0 dB to a maximum of 20.0 dB.
Default value is 0.0 dB

BAL/PAN



This control works as a panpot adjuster, it allows you to control the sound spaciality from left to right.

The parameter has a 0.5 step for a maximum minimum of -12.0 to a maximum of 12.0
Default value is 0

AUX-1

This submenu could be used to specify the behaviour of the current audio source in relation with the logical output AUX-1.

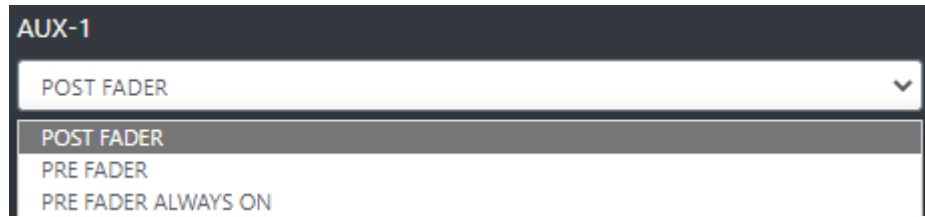

PRE FADER: The fader movement of the channel does not affect the AUX-1 logical output signal.

POST FADER: The fader movement of the channel affects the AUX-1 logical output signal.

PRE FADER ALWAYS ON: The fader movement of the channel does not affect the AUX-1 logical output signal and the source is always forwarded to the AUX-1 logical output, bypassing the ON button of the channel

AUX-2

This submenu could be used to specify the behaviour of the current audio source in relation with the logical output AUX-1.



PRE FADER: The fader movement of the channel does not affect the AUX-2 logical output signal.

POST FADER: The fader movement of the channel affects the AUX-2 logical output signal.

PRE FADER ALWAYS ON: The fader movement of the channel does not affect the AUX-2 logical output signal and the source is always forwarded to the AUX-2 logical output, bypassing the ON button of the channel

BUTTON LIGHT



Between available colors, select the one to be assigned to the following channel buttons:

F1, EQ, PGM, SUB, AUX1, AUX2

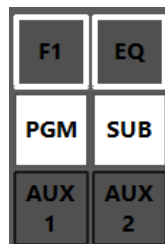

ON



The selection affects all the channels to which this audio source is assigned.

To modify the customizable COLOR 1, COLOR 2, COLOR 3, COLOR 4, go in the menu:

SETUP / GENERAL / LIGHT&DISPLAY

FADER BAR LIGHT

Between available colors, select the one to be assigned to the following channel controls:
ON led, GAIN adjustment

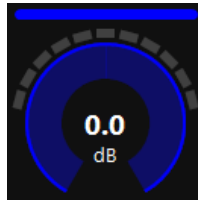

FADER BAR, FADER SLIDER

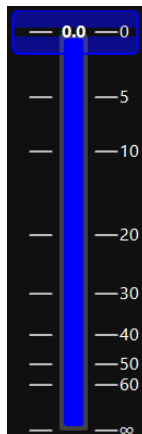

PHASE

The PHASE controller allows you to flip the phase of the signal wave with a rotation of 180°. The rotation of the phase allows you to avoid the phase cancellation due to destructive interferences with a different signals

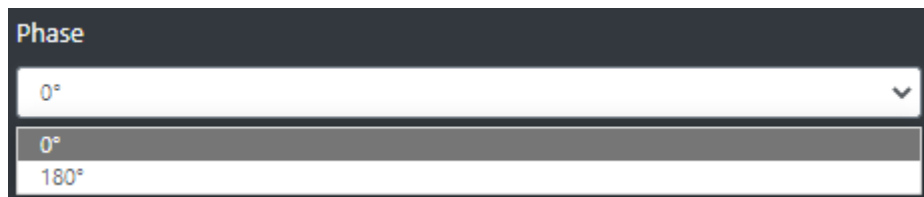

0°: the selection of this option will keep the original signal phase

180°: the selection of this option will apply a phase flipping (horizontal axial symmetry) of 180°.

ON MODULE



BY BUTTON & FADER: The airing of the channel needs an interaction of the ON button and a slide up of the fader.

The channel to be considered ON has to be into the following status:

ON = active

SLIDER = higher than $-\infty$

BY FADER: The airing of the channel needs only a slide up of the fader. The OFF status of the channel could only be reached by sliding down the fader and not by ON button pressure.

The channel to be considered ON has to be into the following status:

SLIDER = higher than $-\infty$

BY BUTTON: The airing of the channel needs only an interaction with the ON button:

The channel to be considered ON has to be into the following status:

ON = active

The slider movements will not affect the ON/OFF status of the channel.

ALWAYS ON: The channel is always considered ON. The sliding down of the fader never put the channel in OFF status.

ALWAYS OFF: The channel is always considered OFF.

4.4.1.2.2 MONO (EQ)

LOW CUT

Low cut (or High Pass filter) is designed to remove all the audio frequencies below the decided one.



Enable: Enable/Disable the application of this Low Cut filter on the audio signal of the current source.

Frequency: All the frequencies below the selected one will be cut off.

BASS / BASS MID / MID / MID HIGH / HIGH

In OXYGEN 1000 and OXYGEN 2000 the equalizer allows a multi-band adjustment of the EQ parameters.

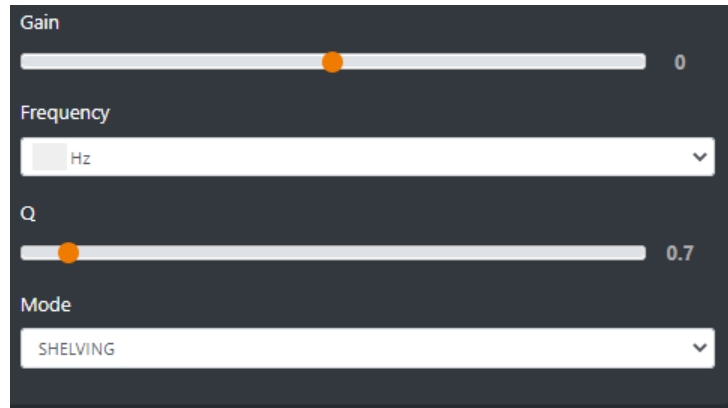

Above the involved parameters to manage: AMPLITUDE, CENTER FREQUENCY, and BANDWIDTH.

GAIN slider controls the amplitude of each band.

FREQUENCY sub-menu can shift and select the central frequency.

Q slider is inversely related to the Bandwidth (which is inversely related to "Q"), Q allows the Bandwidth to be widened or narrowed.

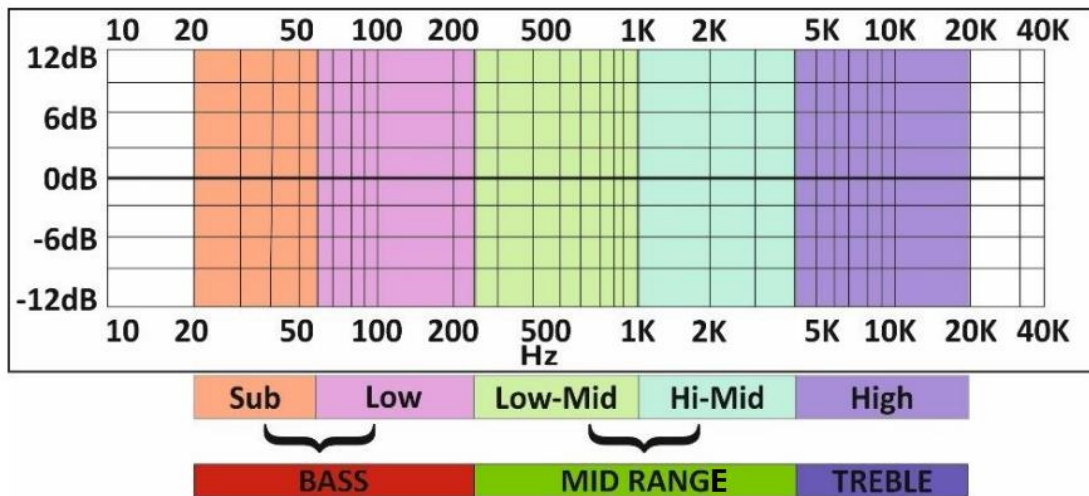

MODE only works in SHELVING mode for BASS and HIGH (not for BASS-MID, MIDDLE and MID HIGH).

Peak is related to a specific center frequency choosable by FREQUENCY, Q will be applied on the left and on the right of the chosen FREQ. it has to be chosen the center frequency and by the Q factor you can decide to enlarge or to restrict the application curve of the decided gain.

Shelving applies the GAIN on the frequencies before the chosen FREQ (for BASS) and on the frequencies after the chosen FREQ (for HIGH) . The Q factor represents the decreasing slope to be applied from the maximum to the minimum point.

HIGH CUT

High Cut (or Low Pass filter) is designed to remove all the audio frequencies above the selected one.



Enable: Enable/Disable the application of this High Cut filter on the audio signal of the current source.

Frequency: All the frequencies below the selected one will be cut off.

GENERAL MODE

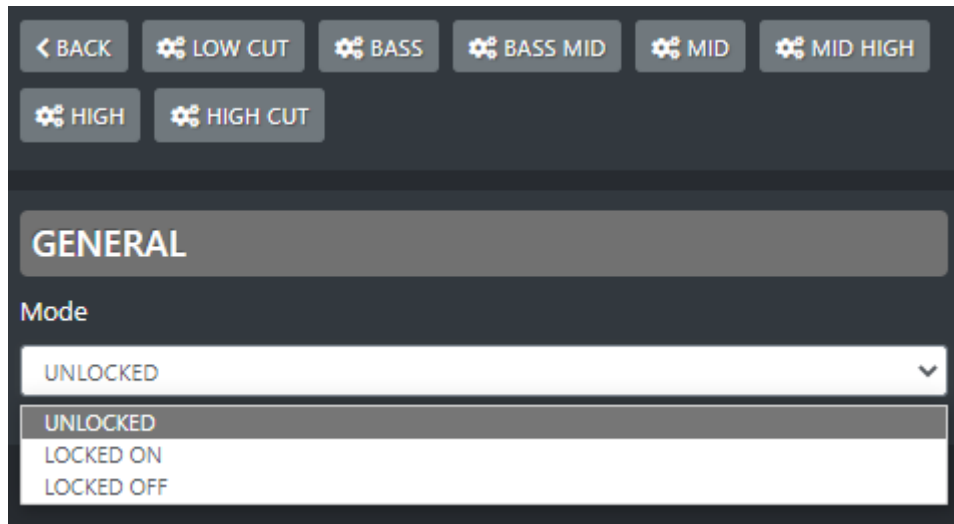

UNLOCKED: This mode always allows to enable/disable EQ by the pressure of the related EQ button of the channel.

LOCKED ON: This mode forces the related EQ button of the channel always ON

LOCKED OFF: This mode forces the related EQ button of the channel always OFF

4.4.1.2.3 MONO (COMPRESSOR)

The COMPRESSOR section is useful for MONO sources for little adjustments on the COMPRESSION already applied by the external MIC amplifier.

Dynamic range compression (**DRC**) or simply compression is an audio signal processing operation that reduces the volume of loud sounds or amplifies quiet sounds thus reducing or compressing audio signals in **DYNAMIC RANGE**. Compression is commonly used in sound recording and reproduction, broadcasting, live sound reinforcement, and some instrument amplifiers.

EXPANDER

The dynamic settings need to be defined by starting with the **EXPANDER THRESHOLD** parameter definition.

The suggested value for the **EXPANDER THRESHOLD** is **-50 dB**.

- The signal lower than this value will be gated and will not be considered.
- The signal higher than this value will be expanded according to the **EXPANDER RATIO**.
Highing up the RATIO too much will high up a bit also the background noise.

COMPRESSOR and **LIMITER** will only act on the considered values, the once higher than the current **EXPANDER THRESHOLD**.

COMPRESSOR

The **COMPRESSOR THRESHOLD** defines a maximum dB value at which all the considered signal must be kept. The signals that exceed this threshold must be reduced in accordance with the **COMPRESSOR RATIO**. The speed of action of this reduction is not immediate, but is adjustable by the **COMPRESSOR RATIO**. its purpose is to pump up the sound, reducing its general dynamics.

The suggested value for the **COMPRESSOR THRESHOLD** is between **-6 dB < C. THRESHOLD < -2 dB**.

- The signal lower than this value will be kept inaltered.
- The signal higher than this will be reduced according to the **COMPRESSOR RATIO**.

LIMITER

The **LIMITER THRESHOLD** acts as a fast signal reduction. The action of the LIMITER is much faster and harder, unlike the slower and softer action of the compressor. The suggested value for **the LIMITER THRESHOLD** is **6 dB**.

- The signal lower than this value will be kept inaltered.
- The signal higher than this value will be cut out in real time.

The **LIMITER RATIO** parameter is useless, because the action will take instantaneously all the signals higher than **LIMITER TRESHOLD** to the same set **LIMITER THRESHOLD**.

4.4.1.2.4 MONO (DUCKING)

The DUCKING system allows you to automatically lower the signals of the music while the speakers talk to their MICROPHONES.

For this reason, OXYGEN 1000 and OXYGEN 2000 have been designed with a very useful DUCKING function, which fulfills this need.

In the musical programs when it is mixed with a speech that needs drop music when the anchorman or the guest starts speaking. the background music instantly drops, then it pops right back up again as soon as that person finishes talking. This happens when the ducking effect in action.

Ducking temporarily lowers, or “ducks,” the volume level of a specified audio signal anytime a second specified audio signal is present. In live sound, ducking is commonly used to lower background music anytime a person speaks, then raises it when that person finishes speaking

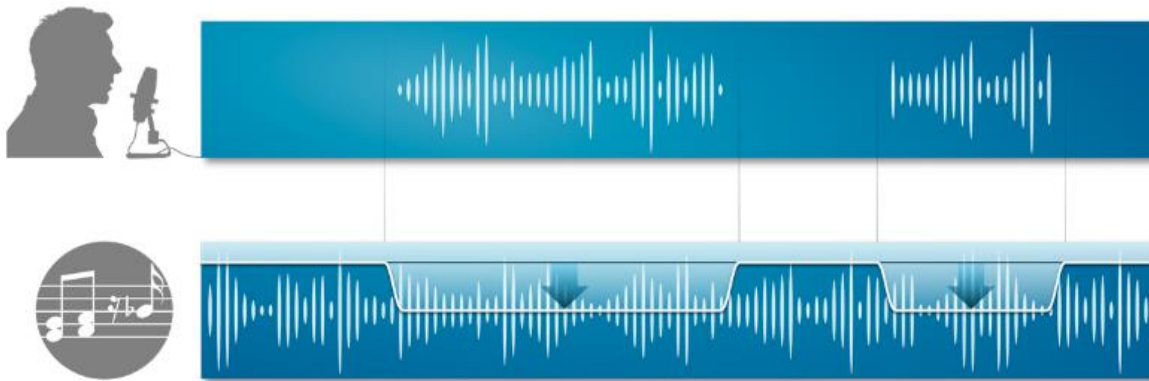

MASTER & SLAVE is the logic on which this functionality is based.

Each console source can be defined as a MASTER source or a SLAVE source.

Usually broadcast microphones are defined as MASTER microphones and other sources in which there is music are defined as SLAVE.

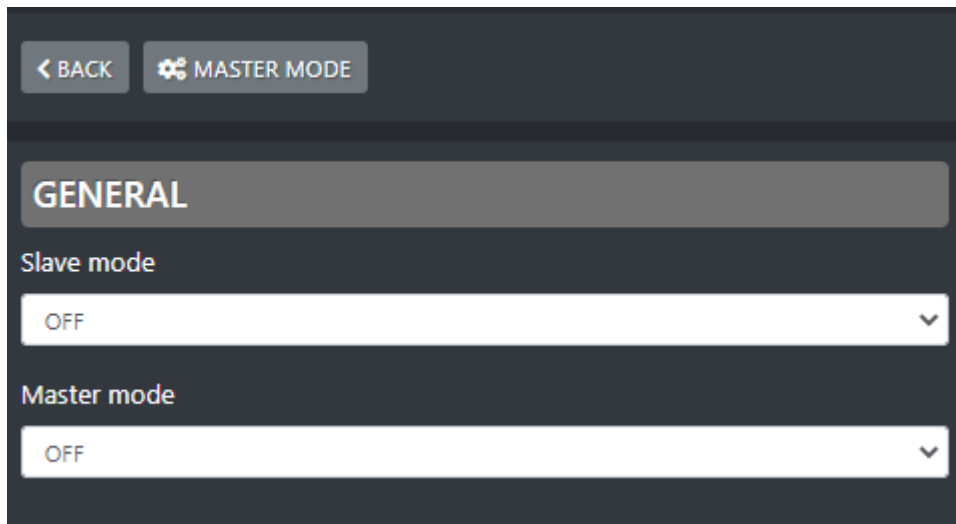
**SLAVE MODE:**

OFF - in this case the current source will never be lowered when any MASTER source is on air.

ON - in this case the current source will be lowered in level, whenever a MASTER source is on air.

MASTER MODE:

OFF - in this case the current source is not selected as the MASTER source. When it is on air, the sources set as SLAVE sources will not be lowered.

ON - in this case the current source is selected as the MASTER source. When it is on air, the sources set as SLAVE sources will automatically be lowered.

ON/OFF F1: The selected MONO source works in MASTER MODE only if you press the F1 button of the related channel.

If MASTRER MODE=ON press

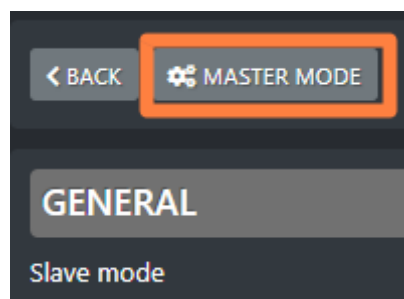

to enter its configuration panel where it will be possible to decide the behavior of all the SLAVE sources, when this MASTER is onair:

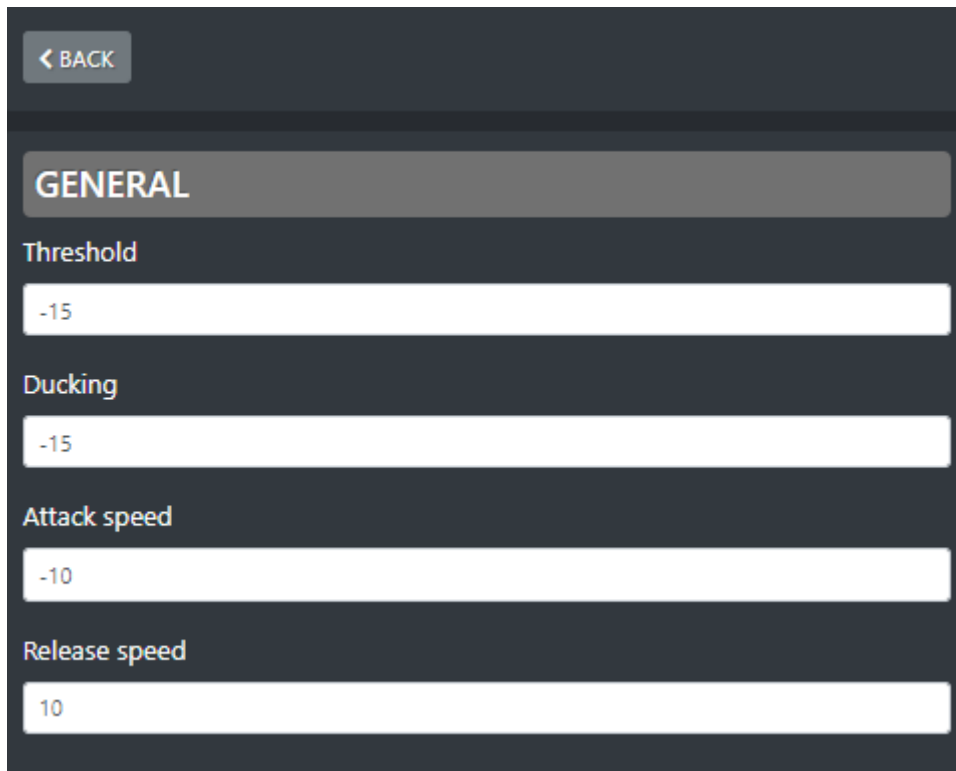

The screenshot shows a dark-themed settings panel with a '< BACK' button at the top left. Below it is a 'GENERAL' header. The settings are as follows:

Setting	Value
Threshold	-15
Ducking	-15
Attack speed	-10
Release speed	10

Threshold: minimum audio threshold (dB) relative to this same source. When this audio source reaches this minimum threshold level, DUCKING will be activated for the lowering of all the other sources set as SLAVE.

Ducking: lowering (in dB) performed on all SLAVE sources.

Attack speed: DUCKING activation speed of the current source when its DUCKING activates.

Release speed: speed at which the DUCKING of the current source is deactivated when the same source stops to be on air.

4.4.2.1 STEREO

Inside the STEREO subsection you will see all the available sources of the current STEREO input category.

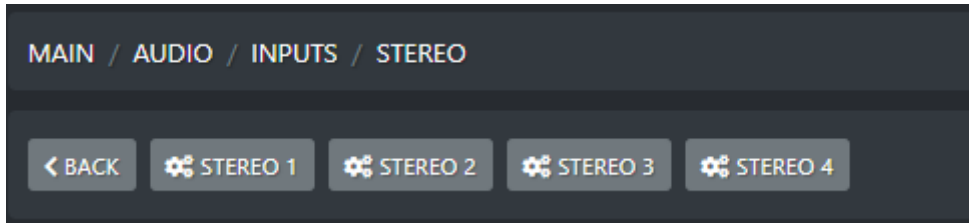

The only available mode for STEREO 4 is the STEREO line input mode.

STEREO 1 (LINE 1 connectors), STEREO 2 (LINE 2 connectors), STEREO 3 (LINE 3 connectors) can be used in a mode other than standard STEREO.

Activating each of them in secondary mode will cause them to be lost among the available sources.

Stereo 1 (LINE 1 connectors) has two secondary modes.

- The 1st secondary mode transforms its R connector into a MONO source, and its L connector into an additional MONO connector.

ANALOG-IN-1 input can be transformed into 2 MONO independent inputs by:

SETUP / AUDIO / SETTINGS / INPUT MODE / LINE 1 mode = 2 MONO

MONO 1 (LINE-1-L)

MONO 2 (LINE-1-R)

- The 2nd secondary mode transforms its R connector into an additional mono TELCO input and its L connector into an additional second mono TELCO input

ANALOG-IN-1 input can be transformed into 2 TELCO independent inputs by:

SETUP / AUDIO / SETTINGS / INPUT MODE / LINE 1 mode = 2 TELCO

TELCO 2-input (LINE-1-L) -----> TELCO 2-output **cleanfield n-1** (ANALOG-OUT-2-L)

TELCO 3-input (LINE-1-R) -----> TELCO 3-output **cleanfield n-1** (ANALOG-OUT-2-R)

STEREO 2 and STEREO 3 can be used in a mode other than standard STEREO. Activating each of them in secondary mode causes the loss of the same standard stereo source.

Each Stereo 2 (LINE 2 connectors) and STEREO 3 (LINE 3 connectors) input has only a secondary mode.

The R connector could be turned into a MONO source, and the L connector into another MONO source.

ANALOG-IN-2 input can be transformed into 2 MONO independent inputs by:

SETUP / AUDIO / SETTINGS / INPUT MODE / LINE 2 mode = 2 MONO

MONO 3 (LINE-2-L)

MONO 4 (LINE-2-R)

ANALOG-IN-3 input can be transformed into 2 MONO independent inputs by:

SETUP / AUDIO / SETTINGS / INPUT MODE / LINE 3 mode = 2 MONO

MONO 5 (LINE-3-L)

MONO 6 (LINE-3-R)

4.4.2.1.1 STEREO (GENERAL)

MODE

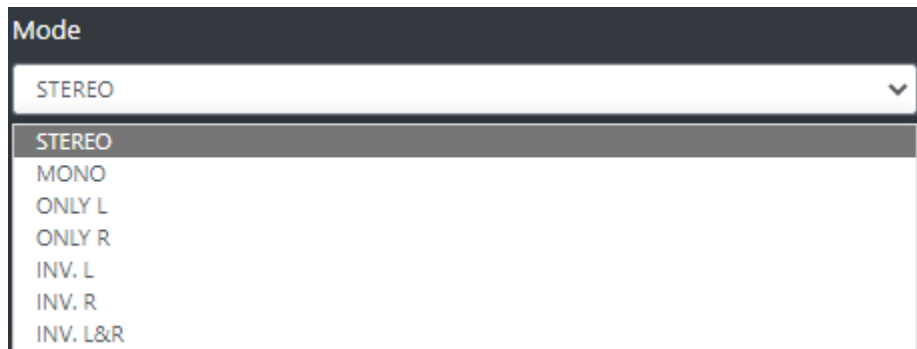

Below an explication of all the STEREO modes:

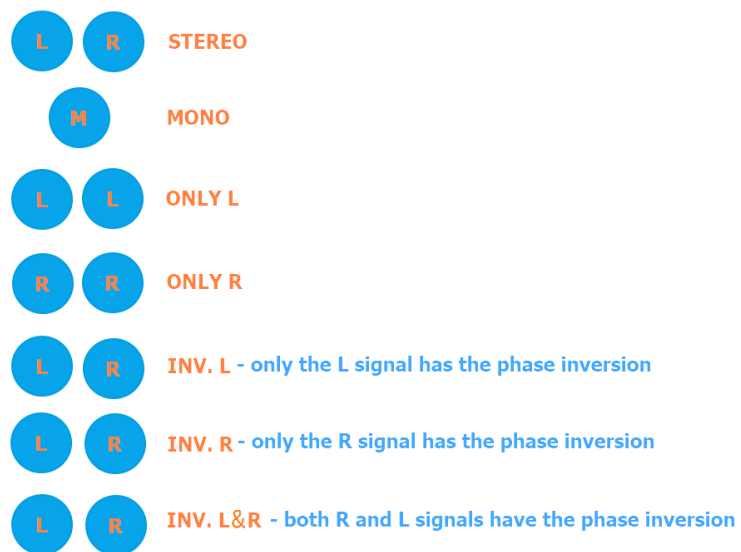

F1 MODE



On each console channel you have one **F1** function button. It could be set to work in one of the following 4 modes. The user is free to select the preferred one.

None: the F1 button of the channel to which this STEREO source is assigned, is disabled.

Ducking: Usually the STEREO sources in the DUCKING rules work as SLAVE signals, so the F1 should not be used because the STEREO channels are set as follow:

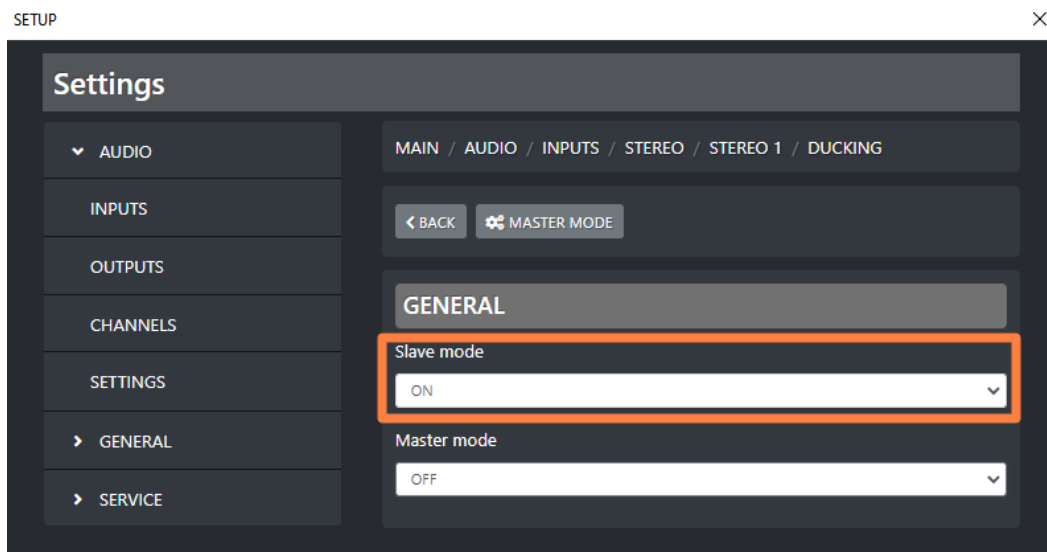

For some special circumstances you may need the STEREO channel set as a DUCKING MASTER, and the behaviour of the related F1 button in DUCKING mode depends on the following 2 usage ways:

1. By applying a countinuitive pressure on F1 button of the channel to which this STEREO source is assigned, will ENABLE the DUCKING. This will be activated if this STEREO was set to be a Master source in the console DUCKING rules by the following window:

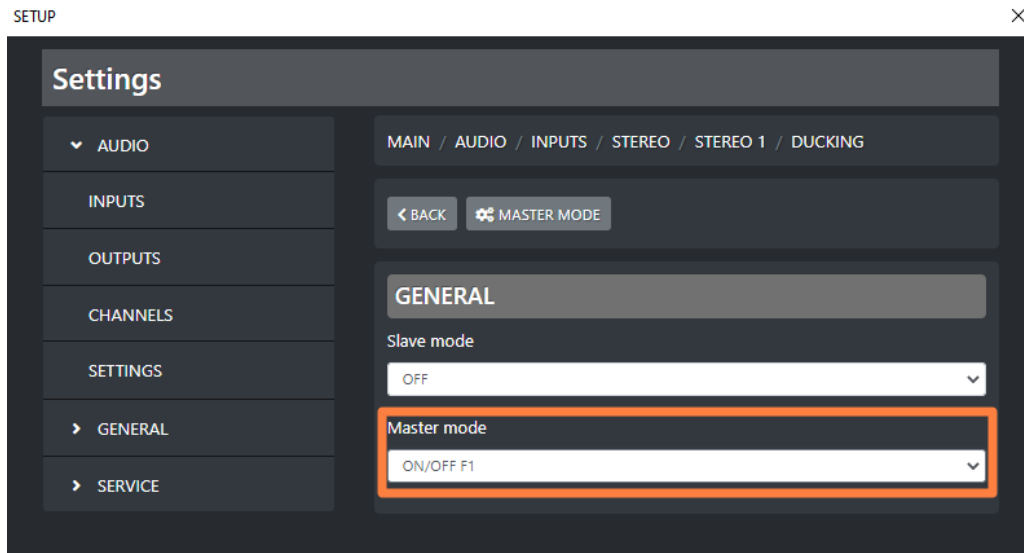

2. If in the same parameter of the previous picture the Master Mode was set as follow:

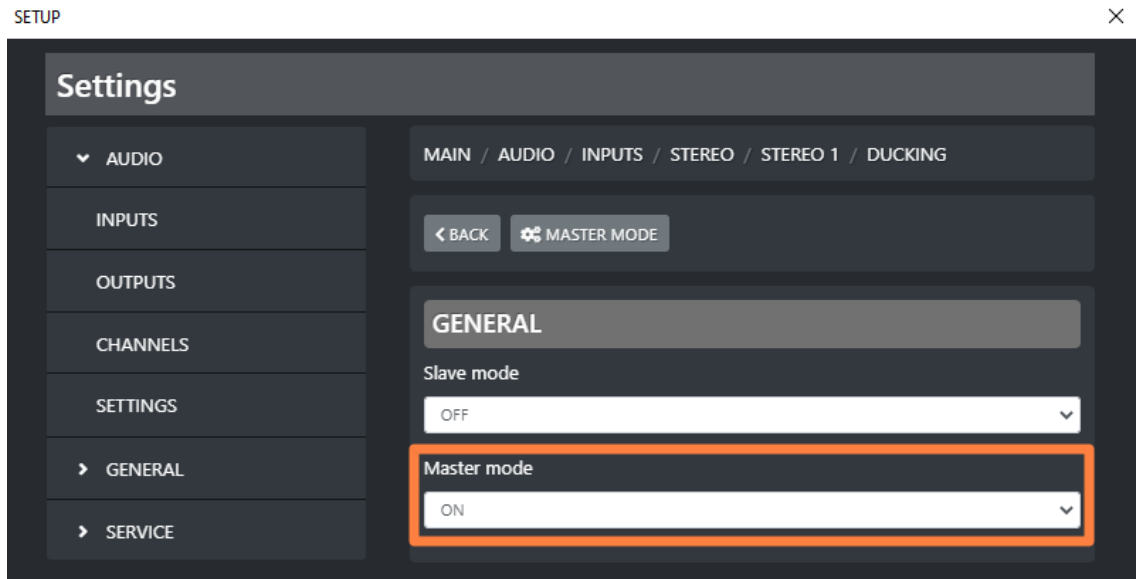

The F1 button to which this STEREO source is assigned, starts blinking while its DUCKING is currently operating as MASTER.

Eq: The F1 button of the channel in which this STEREO source is assigned to, will ENABLE or DISABLE the equalizer.

CUSTOM NAME



Type in this field a desired customized name for this stereo source. This will allow the director of the program to faster identify this stereo source.

On your OXYGEN REMOTER the name of the channel will be displayed on the top of this stereo channel:

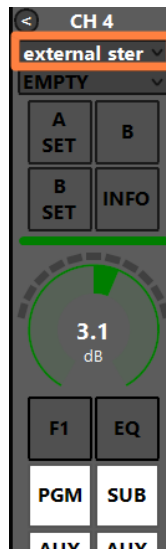

GAIN



This cursor adjusts the STEREO source GAIN.

The same parameter could be modified directly from the related OXYGEN REMOTER channel:



The parameter has a 0.1 dB step for a minimum of -20.0 dB to a maximum of 20.0 dB. Default value is 0.0 dB

BAL/PAN



This control works as a panpot adjuster, it allows you to control the sound spaciality from left to right.

The parameter has a 0.5 step for a maximum minimum of -12.0 to a maximum of 12.0

Default value is 0

AUX-1

This submenu could be used to specify the behaviour of the current audio source in relation with the logical output AUX-1.



PRE FADER: The fader movement of the channel does not affect the AUX-1 logical output signal.

POST FADER: The fader movement of the channel affects the AUX-1 logical output signal.

PRE FADER ALWAYS ON: The fader movement of the channel does not affect the AUX-1 logical output signal and the source is always forwarded to the AUX-1 logical output, bypassing the ON button of the channel

AUX-2

This submenu could be used to specify the behaviour of the current audio source in relation with the logical output AUX-1.

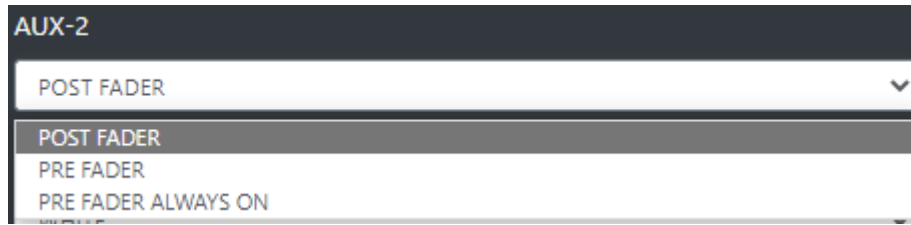

PRE FADER: The fader movement of the channel does not affect the AUX-2 logical output signal.

POST FADER: The fader movement of the channel affects the AUX-2 logical output signal.

PRE FADER ALWAYS ON: The fader movement of the channel does not affect the AUX-2 logical output signal and the source is always forwarded to the AUX-2 logical output, bypassing the ON button of the channel

BUTTON LIGHT



Between available colors, select the one to be assigned to the following channel buttons:

F1, EQ, PGM, SUB, AUX1, AUX2

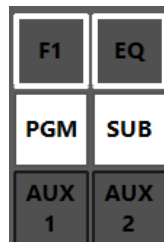

ON

The selection affects all the channels to which this audio source is assigned.

To modify the customizable COLOR 1, COLOR 2, COLOR 3, COLOR 4, go in the menu:

SETUP / GENERAL / LIGHT&DISPLAY

FADER BAR LIGHT

Between available colors, select the one to be assigned to the following channel controls:

ON led, GAIN adjustment

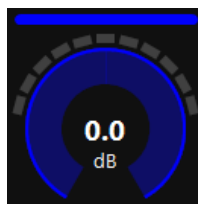

FADER BAR, FADER SLIDER

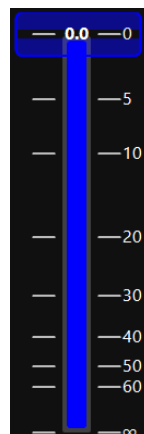

ON MODULE



BY BUTTON & FADER: The airing of the channel needs an interaction of the ON button and a slide up of the fader.

The channel to be considered ON has to be into the following status:

ON = active

SLIDER = higher than $-\infty$

BY FADER: The airing of the channel needs only a slide up of the fader. The OFF status of the channel could only be reached by sliding down the fader and not by ON button pressure.

The channel to be considered ON has to be into the following status:

SLIDER = higher than $-\infty$

BY BUTTON: The airing of the channel needs only an interaction with the ON button:

The channel to be considered ON has to be into the following status:

ON = active

The slider movements will not affect the ON/OFF status of the channel.

ALWAYS ON: The channel is always considered ON. The sliding down of the fader never put the channel in OFF status.

ALWAYS OFF: The channel is always considered OFF.

4.4.2.1.2 STEREO (EQ)

LOW CUT

Low cut (or High Pass filter) is designed to remove all the audio frequencies below the decided one.



Enable: Enable/Disable the application of this Low Cut filter on the audio signal of the current source.

Frequency: All the frequencies below the selected one will be cut off.

BASS / BASS MID / MID / MID HIGH / HIGH

In OXYGEN 1000 and OXYGEN 2000 the equalizer allows a multi-band adjustment of the EQ parameters.

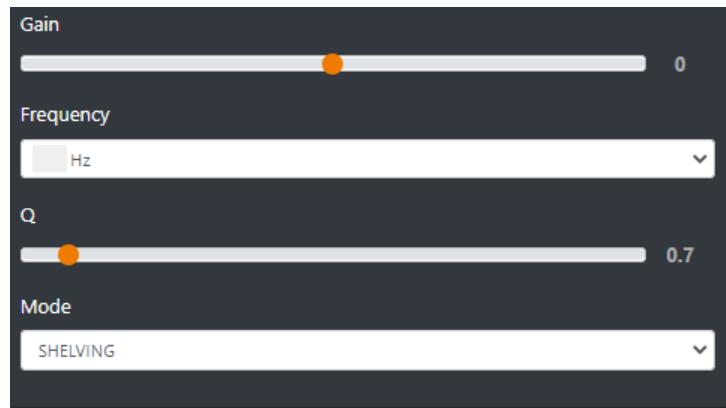

Above the involved parameters to manage: AMPLITUDE, CENTER FREQUENCY, and BANDWIDTH.

GAIN slider controls the amplitude of each band.

FREQUENCY sub-menu can shift and select the central frequency.

Q slider is inversely related to the Bandwidth (which is inversely related to "Q"), Q allows the Bandwidth to be widened or narrowed.

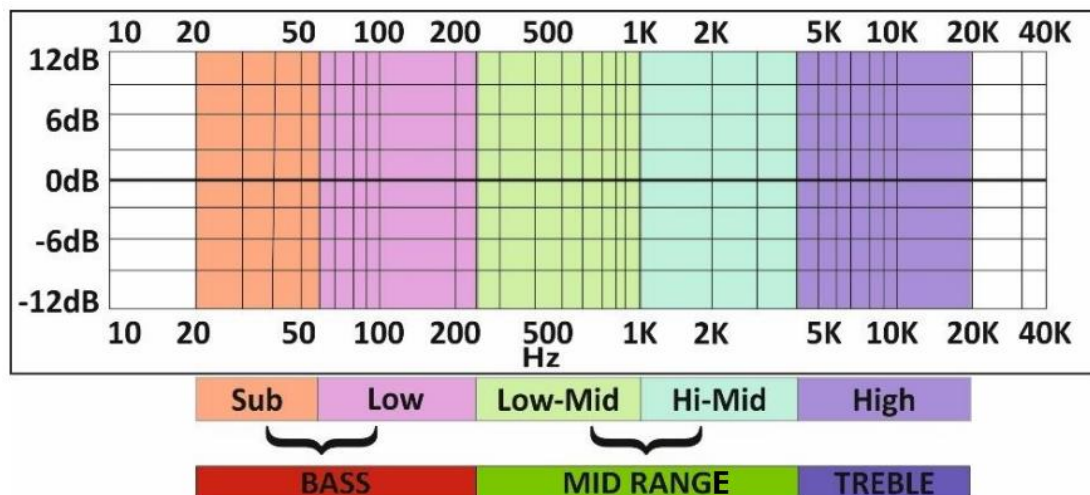

MODE only works in SHELVING mode for BASS and HIGH (not for BASS-MID, MIDDLE and MID HIGH).

Peak is related to a specific center frequency choosable by FREQUENCY, Q will be applied on the left and on the right of the choosen FREQ. it has to be chosen the center frequency and by the Q factor you can decide to enlarge or to restrict the application curve of the decided gain.

Shelving applies the GAIN on the frequencies before the choosen FREQ (for BASS) and on the frequencies after the choosen FREQ (for HIGH) . The Q factor represents the decreasing slope to be applied from the maximum to the minimum point.

HIGH CUT

High Cut (or Low Pass filter) is designed to remove all the audio frequencies above the selected one.



Enable: Enable/Disable the application of this High Cut filter on the audio signal of the current source.

Frequency: All the frequencies below the selected one will be cut off.

GENERAL MODE

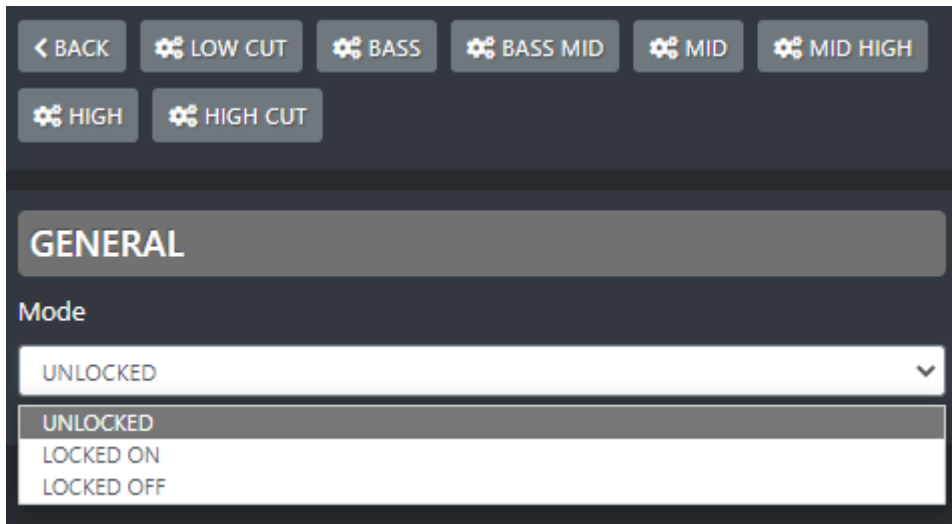

UNLOCKED: This mode always allows to enable/disable EQ by the pressure of the related EQ button of the channel.

LOCKED ON: This mode forces the related EQ button of the channel always ON

LOCKED OFF: This mode forces the related EQ button of the channel always OFF

4.4.2.1.3 STEREO (COMPRESSOR)

Unlike mono and microphone sources, stereo sources **do not have** the COMPRESSOR functionality

4.4.2.1.4 STEREO (DUCKING)

The DUCKING system allows you to automatically lower the signals of the music while the speakers talk to their MICROPHONES.

For this reason, OXYGEN 1000 and OXYGEN 2000 have been designed with a very useful DUCKING function, which fulfills this need.

In the musical programs when it is mixed with a speech that needs drop music when the anchorman or the guest starts speaking. the background music instantly drops, then it pops right back up again as soon as that person finishes talking. This happens when the ducking effect in action.

Ducking temporarily lowers, or “ducks,” the volume level of a specified audio signal anytime a second specified audio signal is present. In live sound, ducking is commonly used to lower background music anytime a person speaks, then raises it when that person finishes speaking



MASTER & SLAVE is the logic on which this functionality is based.

Each console source can be defined as a MASTER source or a SLAVE source.

Usually broadcast microphones are defined as MASTER microphones and other sources in which there is music are defined as SLAVE.

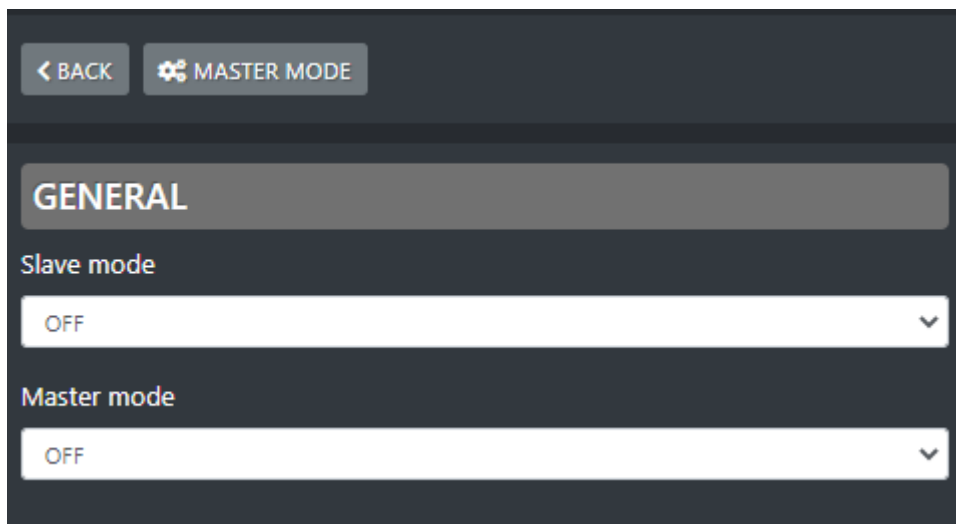

SLAVE MODE:

In the case of a STEREO source the DUCKING MODE is suggested to be the SLAVE one. Usually it is a source with Music or Background sounds.

OFF - in this case the current source will never be lowered when any MASTER source is on air.

ON - in this case the current source will be lowered in level, whenever a MASTER source is on air.

MASTER MODE:

For some special circumstances you may need the STEREO channel set as MASTER.

OFF - in this case the current source is not selected as the MASTER source. When it is on air, the sources set as SLAVE sources will not be lowered.

ON - in this case the current source is selected as the MASTER source. When it is on air, the sources set as SLAVE sources will automatically be lowered.

ON/OFF F1: The selected STEREO source works in MASTER MODE only if you press the F1 button of the related channel.

If MASTRER MODE=ON press

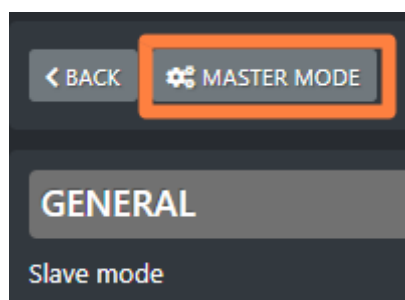

to enter its configuration panel where it will be possible to decide the behavior of all the SLAVE sources, when this MASTER is onair:

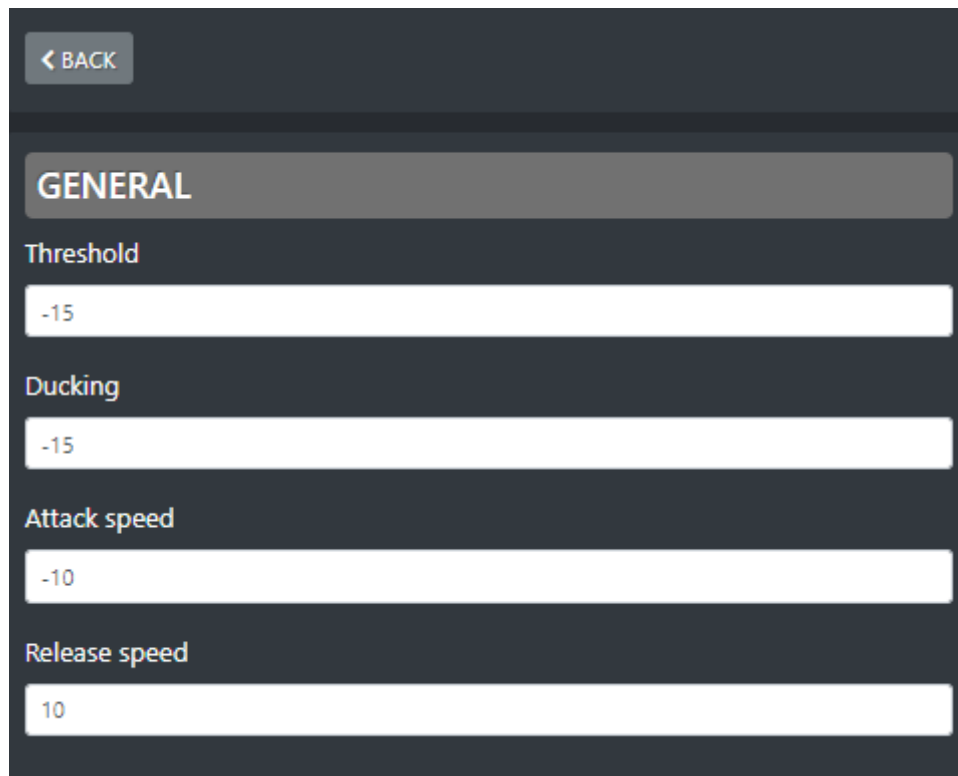

The screenshot shows a dark-themed configuration panel with a '< BACK' button at the top left. Below it is a 'GENERAL' section header. The settings are as follows:

Setting	Value
Threshold	-15
Ducking	-15
Attack speed	-10
Release speed	10

Threshold: minimum audio threshold (dB) relative to this same source. When this audio source reaches this minimum threshold level, DUCKING will be activated for the lowering of all the other sources set as SLAVE.

Ducking: lowering (in dB) performed on all SLAVE sources.

Attack speed: DUCKING activation speed of the current source when its DUCKING activates.

Release speed: speed at which the DUCKING of the current source is deactivated when the same source stops to be on air.

4.4.3.1 TEL/BT

Inside the TEL/BT subsection you will see all the available sources of the current STEREO input category. They are groupable in 3 different TELEPHONE kinds:

- TELCO LINE (by external telephone hybrid)
- TELEPHONE (by the internal telephone hybrid via RJ11 connector plugged in the console back)
- BLUETOOTH (by an external bluetooth device like a mobile or a tablet)

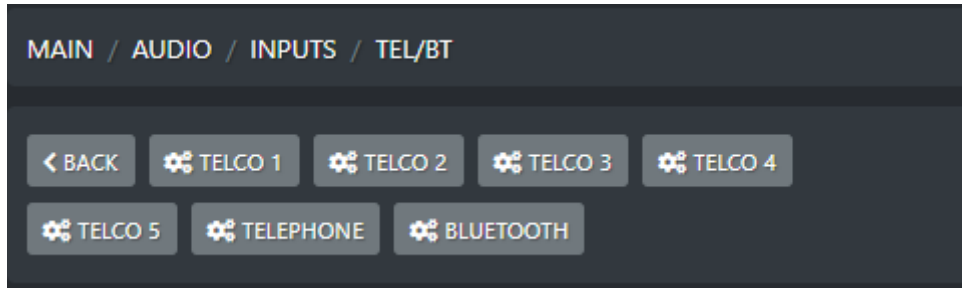

4.4.3.1.1 TELCO 1 / TELCO 2 / TELCO 3 / TELCO 4 / TELCO 5 (GENERAL) F1 MODE



On each console channel you have one **F1** function button. It could be set to work in one of the following 4 modes. The user is free to select the preferred one.

None: the F1 button of the channel to which this TELCO source is assigned, is disabled.

Gpio: The F1 button remotely controls the HOOK/DROP of the external TELCO device (external telephone hybrid) through GPIO electrical signals. The F1 button also blinks while the external TELCO receives an incoming call: the console receives a RING GPI signal. To work in this way, the console GPIO port has to be connected with the GPIO port of this external device.

Device: In case your external TELCO device is the MACROTEL X1/X2 MULTIMODE, the F1 button remotely controls the HOOK/DROP of the external MACROTEL through REST API. The F1 button also blinks while the external TELCO receives an incoming call: the console receives the REST API responses from the MACROTEL. To set the communication with the external MACROTEL you can go in the following DEVICE panel and set all the parameters as you need:

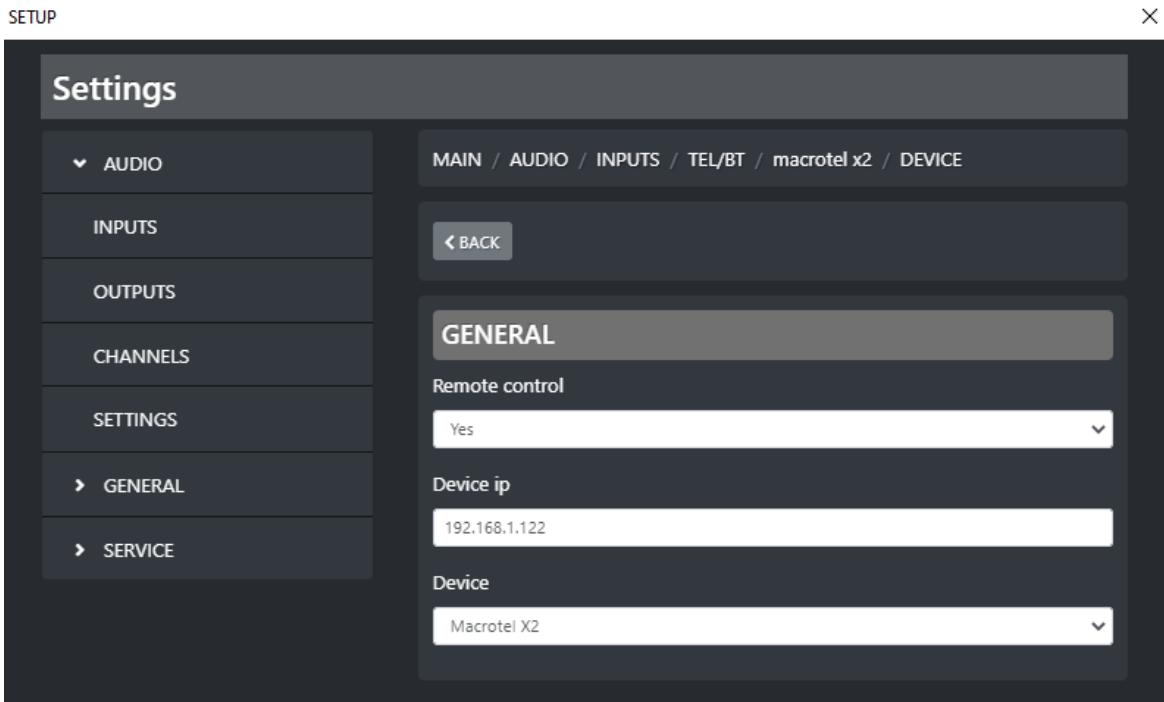

Ducking: Usually the TELCO source has to be set as a MASTER signal.

In fact, during a phone call in progress you may want to keep a background music to give it color.

The TELCO F1 behaviour in DUCKING – MASTER mode depends on the following 2 usage ways

1. By applying a countinuitive pressure on F1 button of the channel to which this TELCO source is assigned, will ENABLE the DUCKING. This will be activated if this TELCO was set to be a Master source in the console DUCKING rules by the following window:

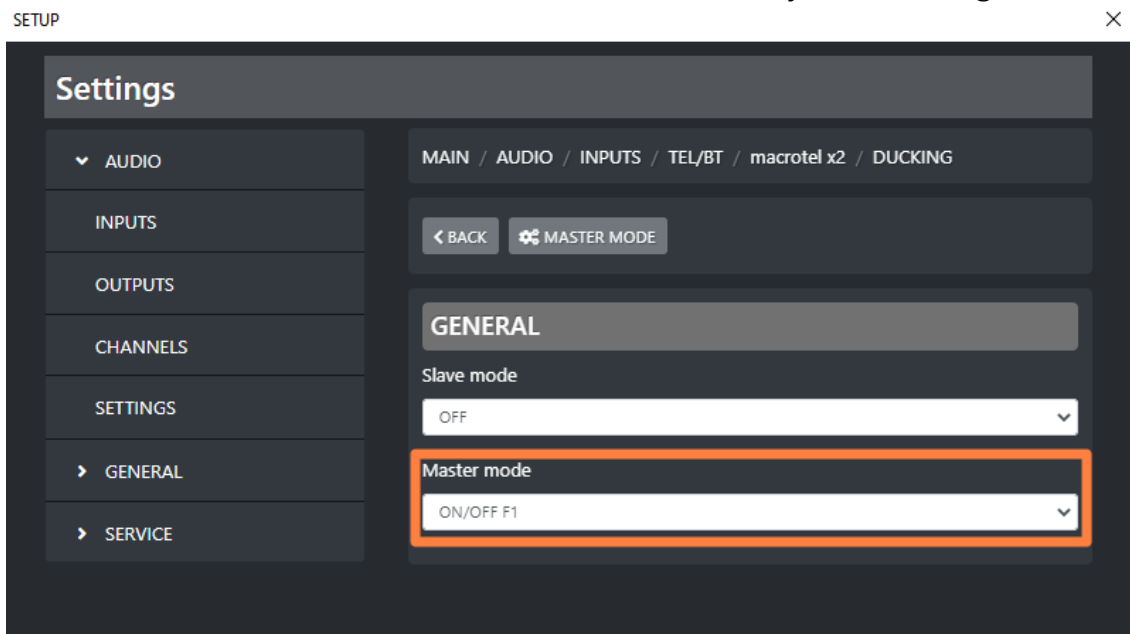

The F1 button to which this TELCO source is assigned, starts blinking while its DUCKING is currently operating as MASTER.

- If in the same parameter of the previous picture the Master Mode was set as follow:

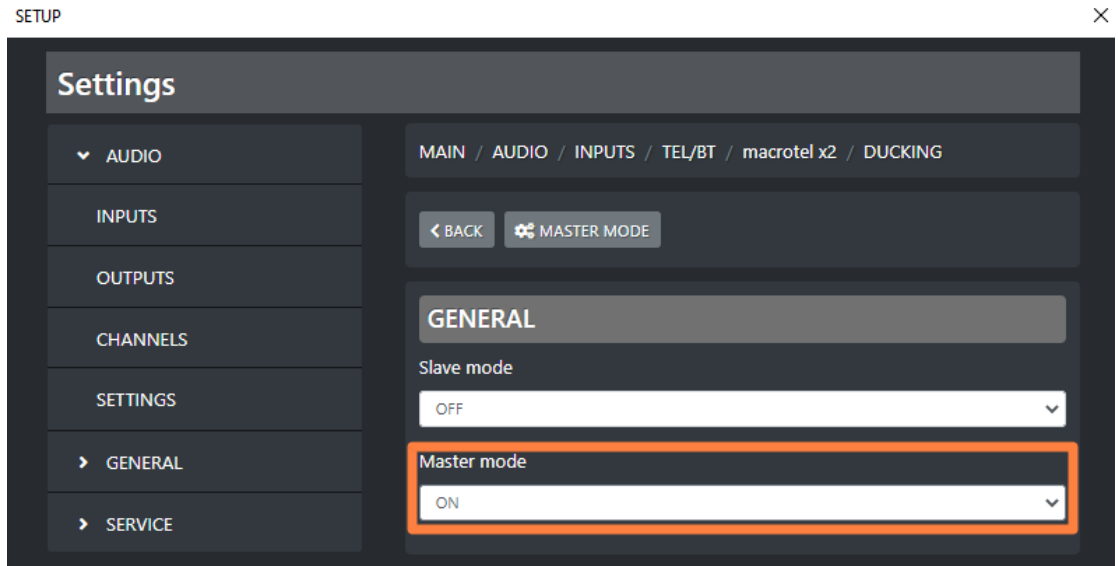

The F1 button to which this TELCO source is assigned, starts blinking while its DUCKING is currently operating as MASTER.

For some special circumstances you may need the TELCO channel set as a DUCKING SLAVE. You should set it as follow:

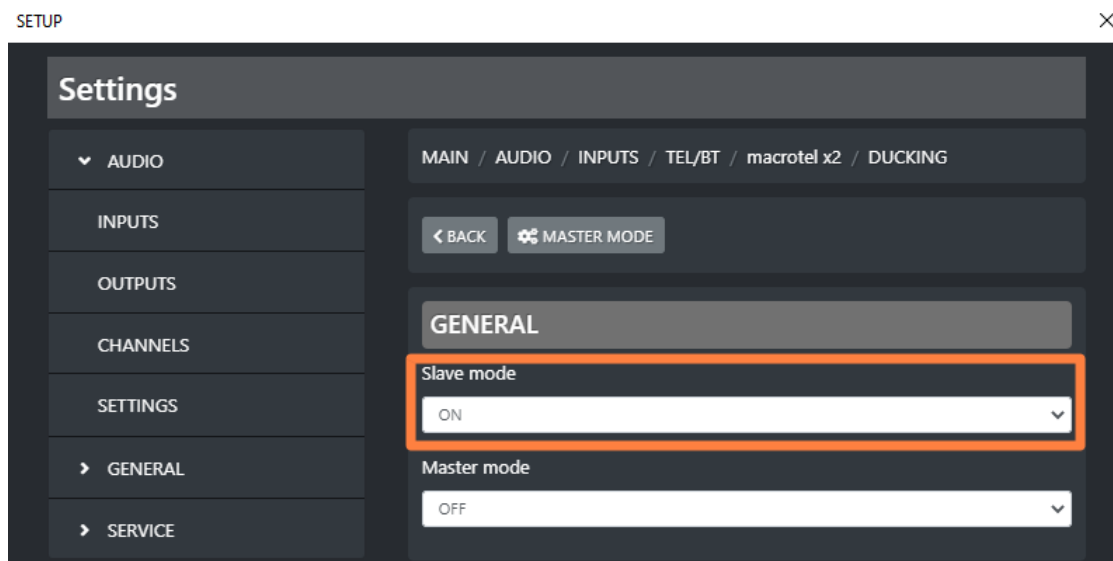

Eq: The F1 button of the channel in which this TELCO source is assigned to, will ENABLE or DISABLE the equalizer.

GAIN TX

In TELCO sources (generally in all of the 3 telephone connections: TELCO, TELEPHONE, BLUETOOTH), you should need an additional GAIN to adjust the audio level received by the caller during a phonecall. To set it or to change it you can use this **GAIN TX** controller.



- In the case you are in a private communication with the caller before airing him/her through TELCO channel with PFL = ON, GAIN TX will be only applied to all the PRIVATE MICS.
- In the case you are ONAIR with the phonecall, with TELCO channel with PFL = OFF, GAIN TX will be applied to the whole logic BUSS sent to the caller. You can select them by the following BUSS selector of the TELCO channel:

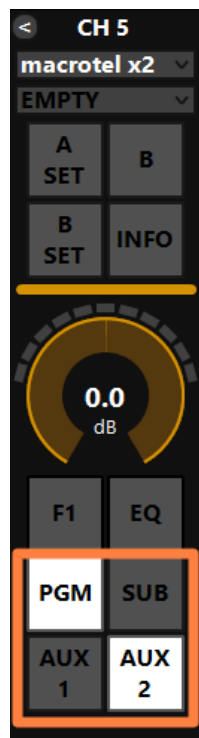

In the previous example, the GAIN TX received by the caller will be applied on the SUM of both PGM and AUX 2 logical BUSS.

CUSTOM NAME



Type in this field a desired customized name for this telco source. This will allow the director of the program to faster identify this telco source.

On your OXYGEN REMOTER the name of the channel will be displayed on the top of this telco channel:



GAIN



This cursor adjusts the gain of the TELCO output signal. This is the Gain RX, it adjusts the audio level of the caller voice. The same parameter could be modified directly from the related OXYGEN REMOTER channel:

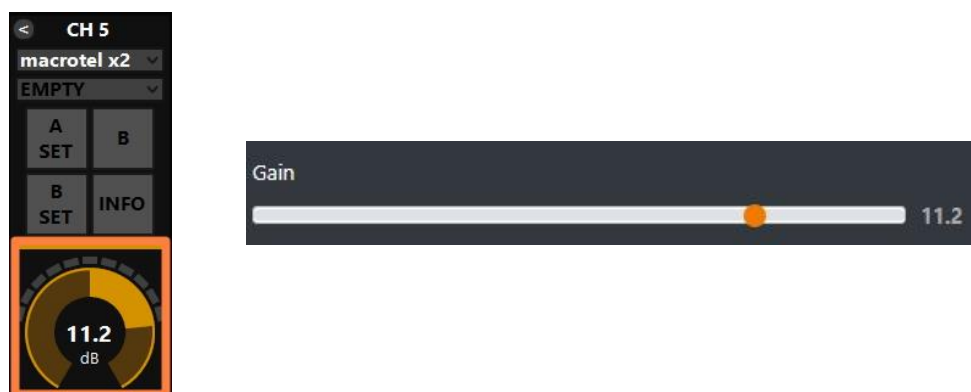

The parameter has a 0.1 dB step for a minimum of -20.0 dB to a maximum of 20.0 dB. Default value is 0.0 dB

BAL/PAN



This control works as a panpot adjuster, it allows you to control the sound spaciality from left to right.

The parameter has a 0.5 step for a maximum minimum of -12.0 to a maximum of 12.0
Default value is 0

AUX-1

This submenu could be used to specify the behaviour of the current audio source in relation with the logical output AUX-1.



PRE FADER: The fader movement of the channel does not affect the AUX-1 logical output signal.

POST FADER: The fader movement of the channel affects the AUX-1 logical output signal.

PRE FADER ALWAYS ON: The fader movement of the channel does not affect the AUX-1 logical output signal and the source is always forwarded to the AUX-1 logical output, bypassing the ON button of the channel

AUX-2

This submenu could be used to specify the behaviour of the current audio source in relation with the logical output AUX-1.



PRE FADER: The fader movement of the channel does not affect the AUX-2 logical output signal.

POST FADER: The fader movement of the channel affects the AUX-2 logical output signal.

PRE FADER ALWAYS ON: The fader movement of the channel does not affect the AUX-2 logical output signal and the source is always forwarded to the AUX-2 logical output, bypassing the ON button of the channel

BUTTON LIGHT



Between available colors, select the one to be assigned to the following channel buttons:

F1, EQ, PGM, SUB, AUX1, AUX2



ON



The selection affects all the channels to which this audio source is assigned.

To modify the customizable COLOR 1, COLOR 2, COLOR 3, COLOR 4, go in the menu:

SETUP / GENERAL / LIGHT&DISPLAY

FADER BAR LIGHT

Between available colors, select the one to be assigned to the following channel controls:

ON led, GAIN adjustment

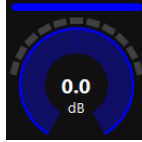

FADER BAR, FADER SLIDER

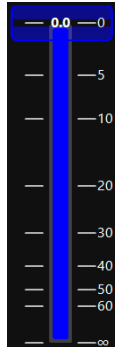

ON MODULE



BY BUTTON & FADER: The airing of the channel needs an interaction of the ON button and a slide up of the fader.

The channel to be considered ON has to be into the following status:

ON = active

SLIDER = higher than $-\infty$

BY FADER: The airing of the channel needs only a slide up of the fader. The OFF status of the channel could only be reached by sliding down the fader and not by ON button pressure.

The channel to be considered ON has to be into the following status:

SLIDER = higher than $-\infty$

BY BUTTON: The airing of the channel needs only an interaction with the ON button:

The channel to be considered ON has to be into the following status:

ON = active

The slider movements will not affect the ON/OFF status of the channel.

ALWAYS ON: The channel is always considered ON. The sliding down of the fader never put the channel in OFF status.

ALWAYS OFF: The channel is always considered OFF.

4.4.3.1.2 TELCO 1 / TELCO 2 / TELCO 3 / TELCO 4 / TELCO 5 (DEVICE)

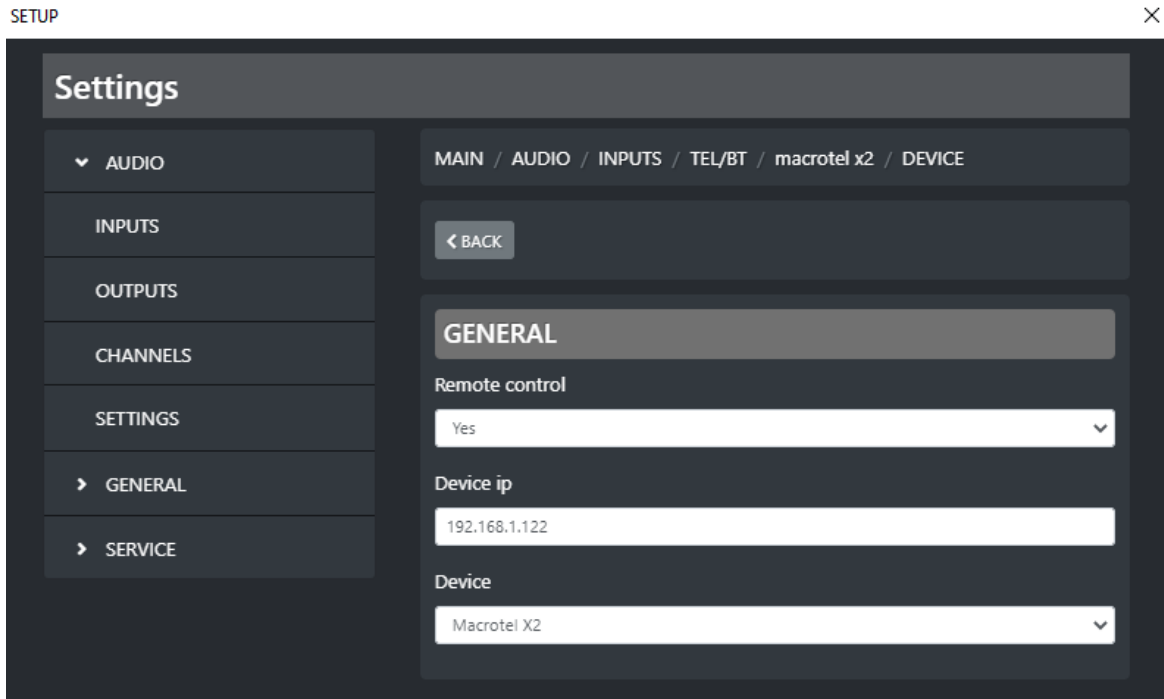

This panel is the one that allows the user to communicate with the external TELCO device (specifically with MACROTEL X1/X2 MULTIMODE) through REST API protocol.

Remote control: Enable/Disable the remote communication with the external TELCO device. The communication protocol used is the REST API one.

Device ip: Device IP of the external TELCO device.

Device: Model of the external AXEL TELCO device.

4.4.3.1.3 TELCO 1 / TELCO 2 / TELCO 3 / TELCO 4 / TELCO 5 (EQ)

LOW CUT

Low cut (or High Pass filter) is designed to remove all the audio frequencies below the decided one.

Enable: Enable/Disable the application of this Low Cut filter on the audio signal of the current source.

Frequency: All the frequencies below the selected one will be cut off.

BASS / BASS MID / MID / MID HIGH / HIGH

In OXYGEN 1000 and OXYGEN 2000 the equalizer allows a multi-band adjustment of the EQ parameters.

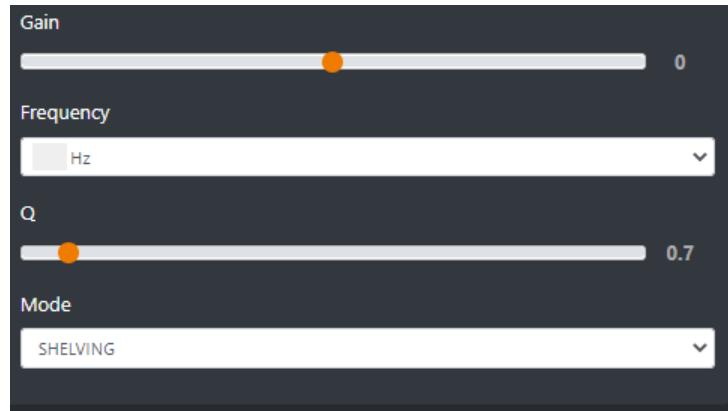

Above the involved parameters to manage: AMPLITUDE, CENTER FREQUENCY, and BANDWIDTH.

GAIN slider controls the amplitude of each band.

FREQUENCY sub-menu can shift and select the central frequency.

Q slider is inversely related to the Bandwidth (which is inversely related to "Q"), Q allows the Bandwidth to be widened or narrowed.

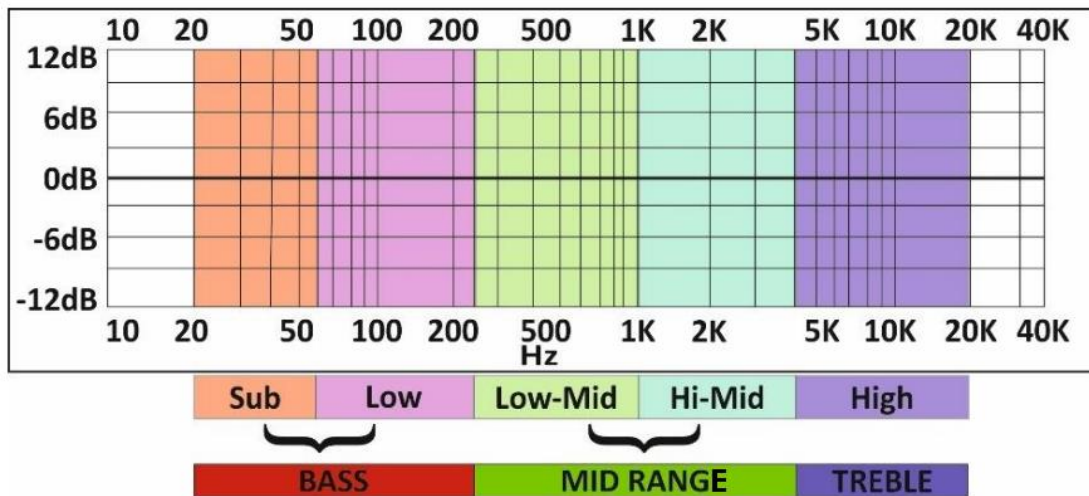

MODE only works in SHELVING mode for BASS and HIGH (not for BASS-MID, MIDDLE and MID HIGH).

Peak is related to a specific center frequency choosable by FREQUENCY, Q will be applied on the left and on the right of the choosen FREQ. it has to be chosen the center frequency and by the Q factor you can decide to enlarge or to restrict the application curve of the decided gain.

Shelving applies the GAIN on the frequencies before the choosen FREQ (for BASS) and on the frequencies after the choosen FREQ (for HIGH) . The Q factor represents the decreasing slope to be applied from the maximum to the minimum point.

HIGH CUT

High Cut (or Low Pass filter) is designed to remove all the audio frequencies above the selected one.



Enable: Enable/Disable the application of this High Cut filter on the audio signal of the current source.

Frequency: All the frequencies below the selected one will be cut off.

GENERAL MODE

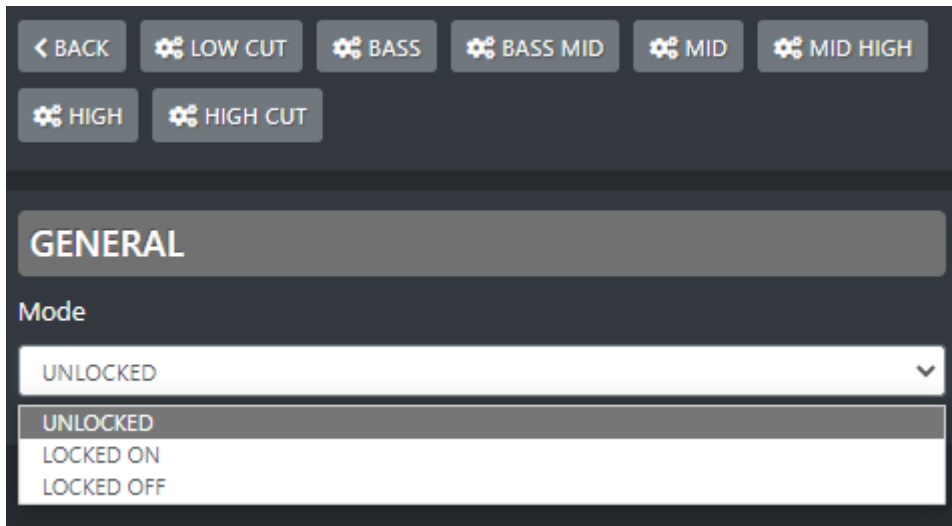

UNLOCKED: This mode always allows to enable/disable EQ by the pressure of the related EQ button of the channel.

LOCKED ON: This mode forces the related EQ button of the channel always ON

LOCKED OFF: This mode forces the related EQ button of the channel always OFF

4.4.3.1.4 TELCO 1 / TELCO 2 / TELCO 3 / TELCO 4 / TELCO 5 (DUCKING)

The DUCKING system allows you to automatically lower the signals of the music while the speakers talk to their MICROPHONES.

For this reason, OXYGEN 1000 and OXYGEN 2000 have been designed with a very useful DUCKING function, which fulfills this need.

In the musical programs when it is mixed with a speech that needs drop music when the anchorman or the guest starts speaking. the background music instantly drops, then it pops right back up again as soon as that person finishes talking. This happens when the ducking effect in action.

Ducking temporarily lowers, or “ducks,” the volume level of a specified audio signal anytime a second specified audio signal is present. In live sound, ducking is commonly used to lower background music anytime a person speaks, then raises it when that person finishes speaking

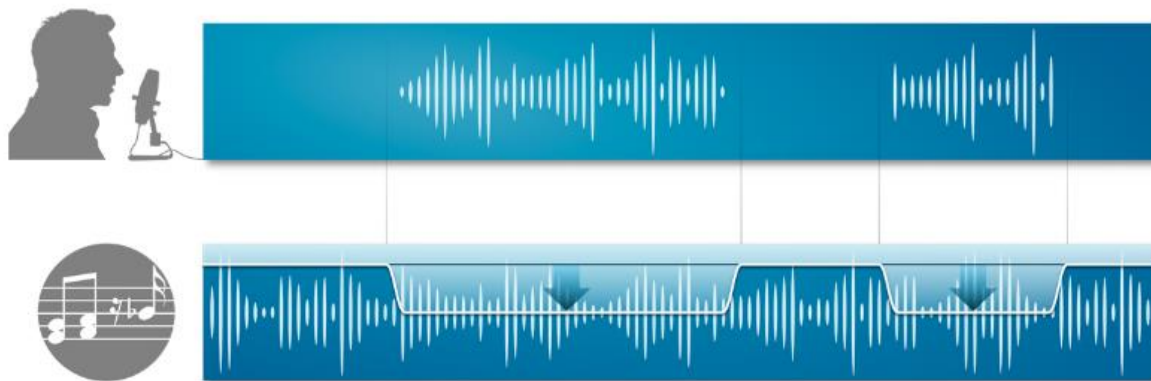

MASTER & SLAVE is the logic on which this functionality is based.

Each console source can be defined as a MASTER source or a SLAVE source.

Usually broadcast microphones are defined as MASTER microphones and other sources in which there is music are defined as SLAVE.

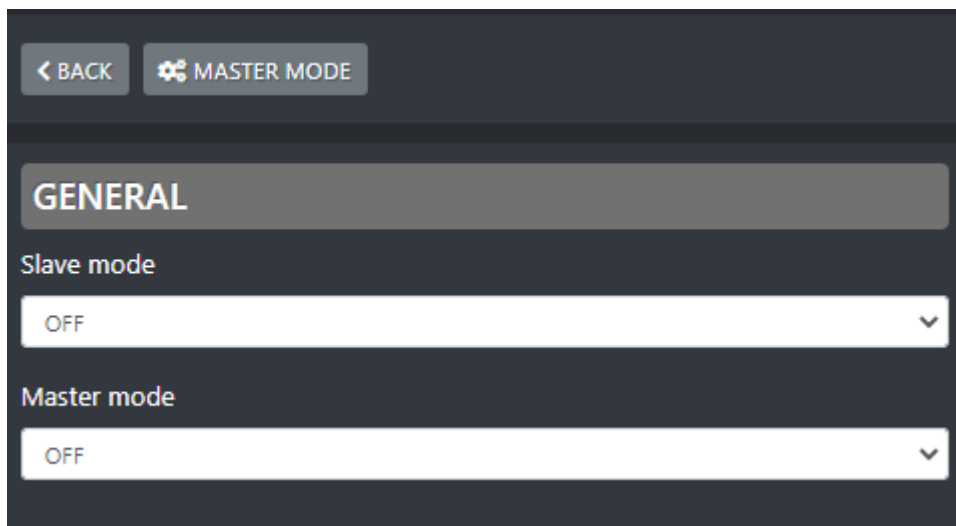
**SLAVE MODE:**

OFF - in this case the current source will never be lowered when any MASTER source is on air.

ON - in this case the current source will be lowered in level, whenever a MASTER source is on air.

MASTER MODE:

OFF - in this case the current source is not selected as the MASTER source. When it is on air, the sources set as SLAVE sources will not be lowered.

ON - in this case the current source is selected as the MASTER source. When it is on air, the sources set as SLAVE sources will automatically be lowered.

ON/OFF F1: The selected TELCO source works in MASTER MODE only if you press the F1 button of the related channel.

If MASTRER MODE=ON press

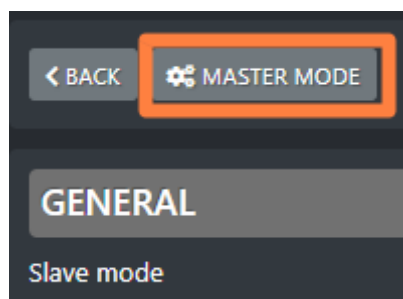

to enter its configuration panel where it will be possible to decide the behavior of all the SLAVE sources, when this MASTER is onair:

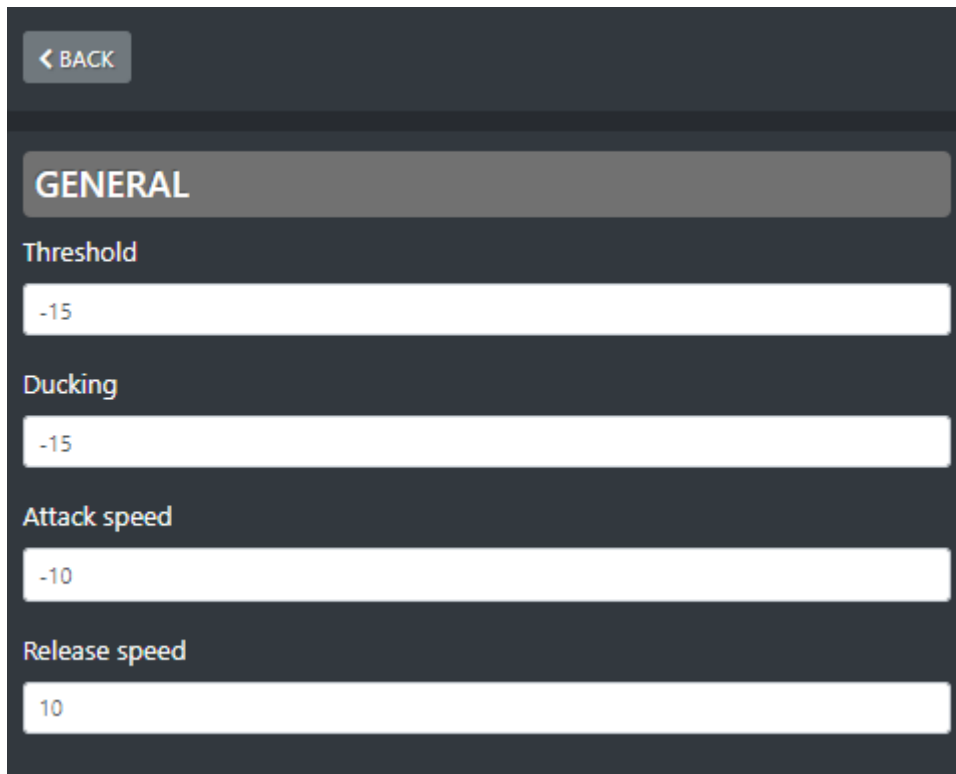

< BACK

GENERAL

Threshold

-15

Ducking

-15

Attack speed

-10

Release speed

10

Threshold: minimum audio threshold (dB) relative to this same source. When this audio source reaches this minimum threshold level, DUCKING will be activated for the lowering of all the other sources set as SLAVE.

Ducking: lowering (in dB) performed on all SLAVE sources.

Attack speed: DUCKING activation speed of the current source when its DUCKING activates.

Release speed: speed at which the DUCKING of the current source is deactivated when the same source stops to be on air.

4.4.3.1.5 TELCO 1 – GPIO MANAGEMENT

The parameters to manage the TELCO 1 - GPIO management reside in the following menu section:

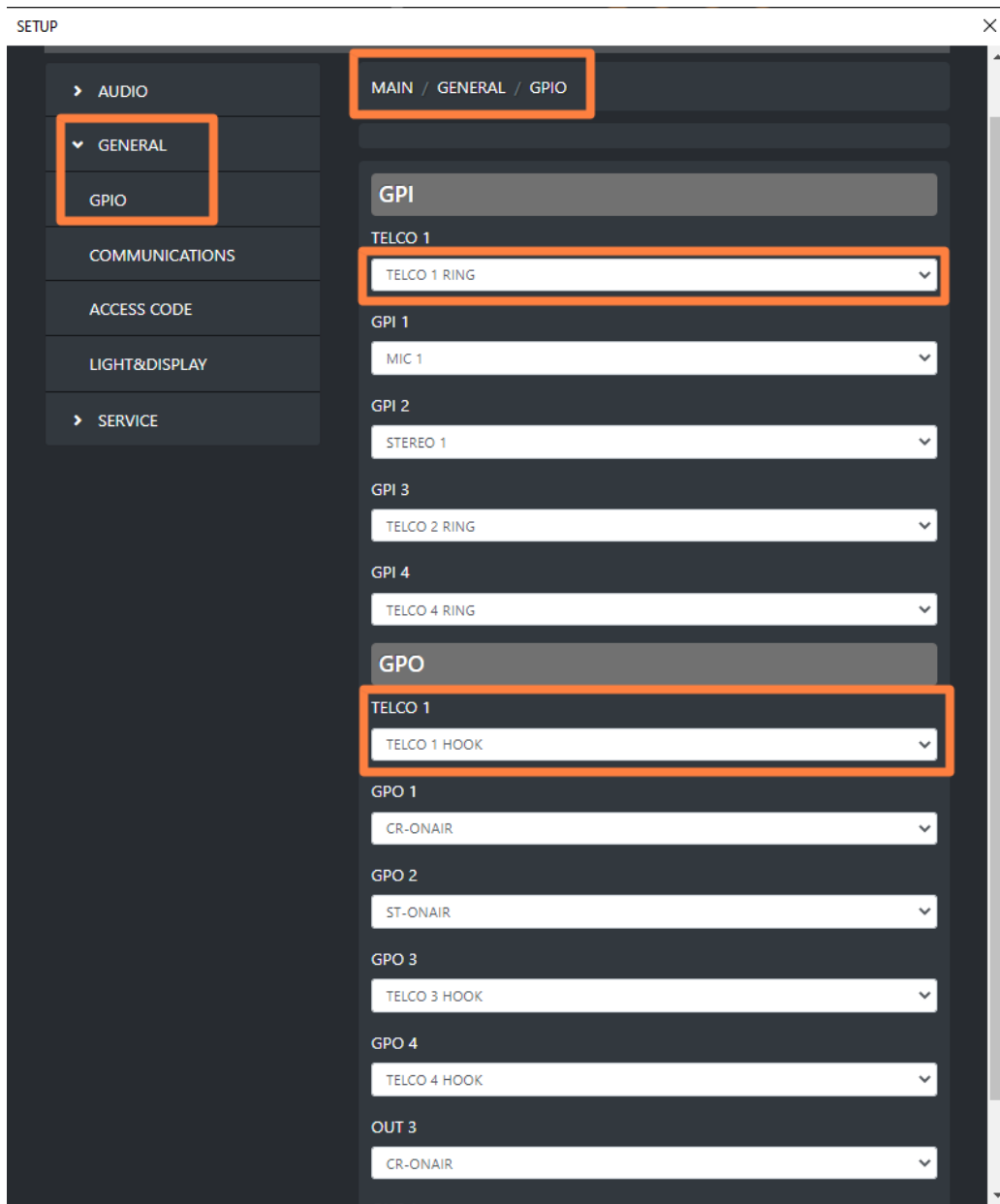

4.4.3.1.6 TELCO 2 / TELCO 3 / TELCO 4 / TELCO 5 ACTIVATION

If needed you can use more than 1 TELCO line.

With proper configurations by SETUP / AUDIO / SETTINGS / INPUT MODE you can have up to 4 more TELCO lines as described below:

ANALOG-IN-1 input can be transformed into 2 TELCO independent inputs by:

SETUP / AUDIO / SETTINGS / INPUT MODE / LINE 1 mode = 2 TELCO

TELCO 2-input (LINE-1-L) -----> TELCO 2-output *cleanfield n-1* (ANALOG-OUT-2-L)

TELCO 3-input (LINE-1-R) -----> TELCO 3-output *cleanfield n-1* (ANALOG-OUT-2-R)

DANTE-1 input can be transformed into 2 TELCO independent inputs by:

SETUP / AUDIO / SETTINGS / INPUT MODE / DANTE 1 mode = 2 TELCO

TELCO 4-input (LINE-1-L) -----> TELCO 4-output *cleanfield n-1* (DANTE-1-L)

TELCO 5-input (LINE-1-R) -----> TELCO 5-output *cleanfield n-1* (DANTE-2-R)

Unlike TELCO 1 that uses RJ45 connector (to transport audio L, audio R, GPI, GPO) TELCO 2, TELCO 3, TELCO 4, TELCO 5 can use the GPO port that is able to use up to 4 more GPI and GPO signals with a cable designed with the correct and its proper pin-out.

For the customizable configuration of all the 4 GPI and 4 GPO signals you can use the menu section:

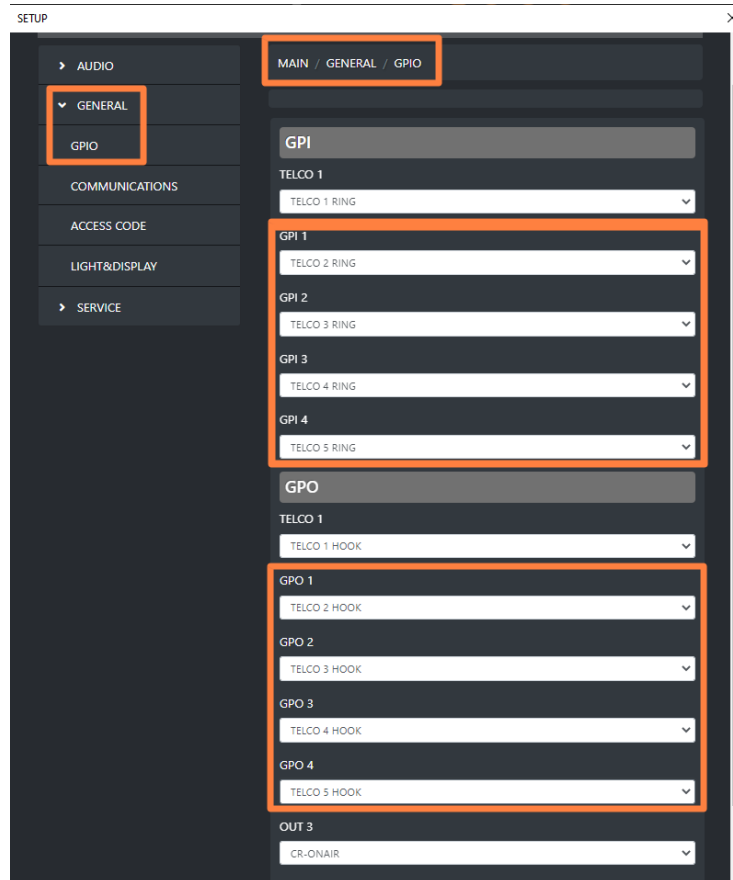

4.4.3.2.1 TELEPHONE (GENERAL)

Telephone source inputs in the console through the RJ11 – TELEPHONE Line connector. The input phone line accepted by this connector is the only analog POTS/PSTN one.

F1 MODE



On each console channel you have one **F1** function button. It could be set to work in one of the following 4 modes. The user is free to select the preferred one.

None: the F1 button of the channel to which this TELEPHONE source is assigned, is disabled.

TELEPHONE: The F1 button controls the HOOK/DROP of the phoneline (internal telephone hybrid). The F1 button also blinks while the phone line receives an incoming call.

Ducking: Usually the TELEPHONE source has to be set as a MASTER signal. In fact, during a phone call in progress you may want to keep a background music to give it color. The TELEPHONE F1 behaviour in DUCKING – MASTER mode depends on the following 2 usage ways

- By applying a countinuitive pressure on F1 button of the channel to which this TELEPHONE source is assigned, will ENABLE the DUCKING. This will be activated if this TELEPHONE was set to be a Master source in the console DUCKING rules by the following window:

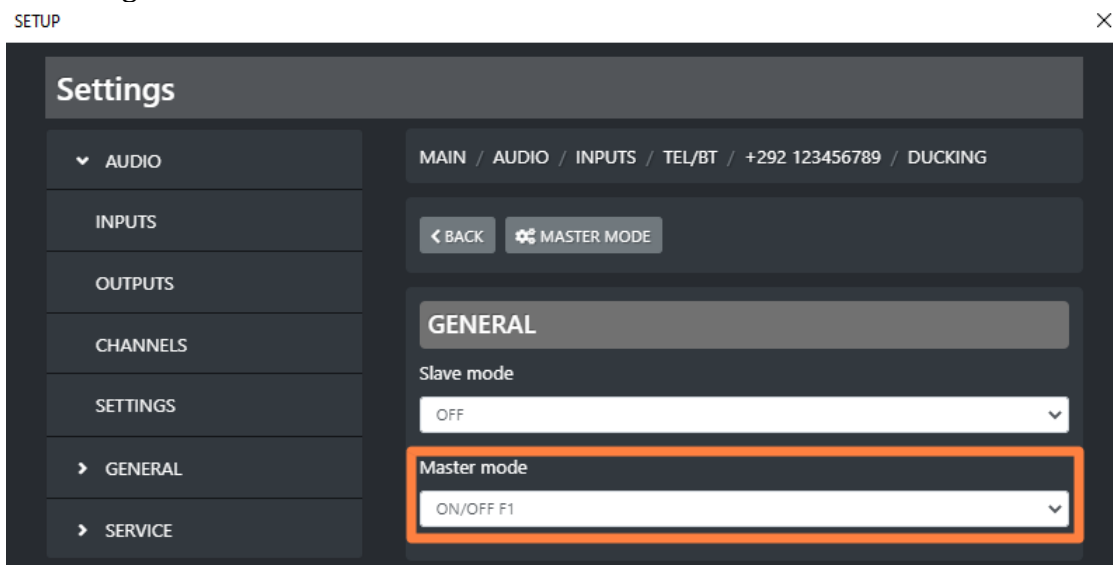

The F1 button to which this TELEPHONE source is assigned, starts blinking while its DUCKING is currently operating as MASTER.

4. If in the same parameter of the previous picture the Master Mode was set as follow:

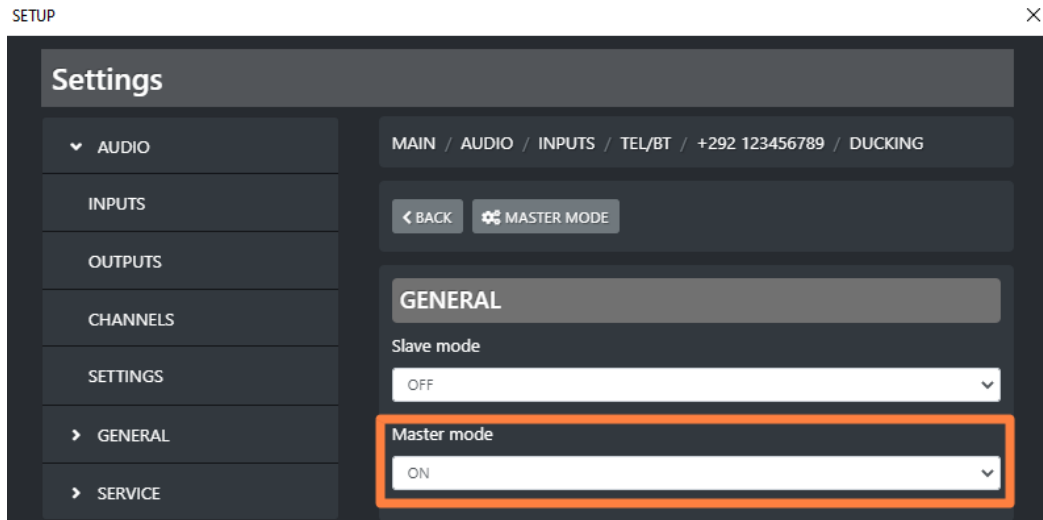

The F1 button to which this TELEPHONE source is assigned, starts blinking while its DUCKING is currently operating as MASTER.

For some special circumstances you may need the TELEPHONE channel set as a DUCKING SLAVE. You should set it as follow:

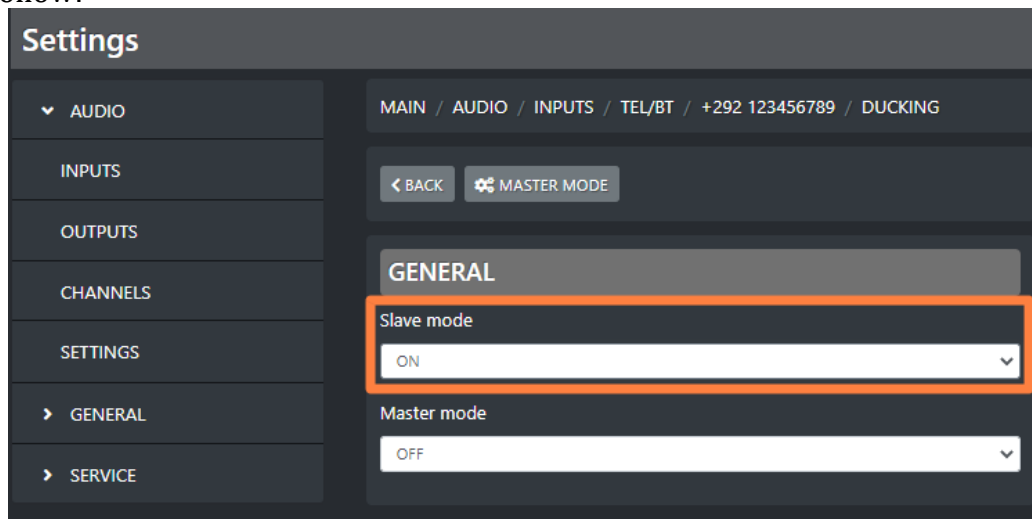

Eq: The F1 button of the channel in which this TELEPHONE source is assigned to, will ENABLE or DISABLE the equalizer.

GAIN TX

In TELCO sources (generally in all of the 3 telephone connections: TELCO, TELEPHONE, BLUETOOTH), you should need an additional GAIN to adjust the audio level received by the caller during a phonecall. To set it or to change it you can use this **GAIN TX** controller.



- In the case you are in a private communication with the caller before airing him/her through TELEPHONE channel with PFL = ON, GAIN TX will be only applied to all the PRIVATE MICS.
- In the case you are ONAIR with the phonecall, with TELEPHONE channel with PFL = OFF, GAIN TX will be applied to the whole logic BUSS sent to the caller. You can select them by the following BUSS selector of the TELEPHONE channel:

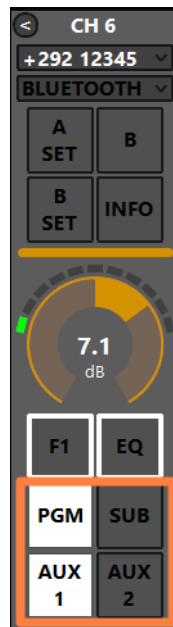

In the previous example, the GAIN TX received by the caller will be applied on the SUM of both PGM and AUX 1 logical BUSS.

CUSTOM NAME



Type in this field a desired customized name for this telco source.
This will allow the director of the program to faster identify this telephone source.

On your OXYGEN REMOTER the name of the channel will be displayed on the top of this telco channel:

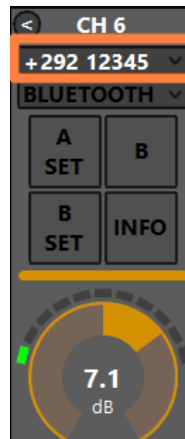

GAIN



This cursor adjusts the gain of the TELCO output signal.
This is the Gain RX, it adjusts the audio level of the caller voice.
The same parameter could be modified directly from the related OXYGEN REMOTER channel:

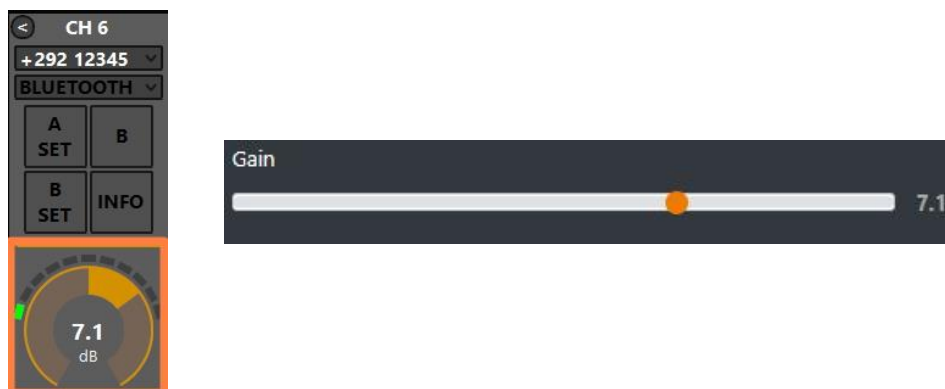

The parameter has a 0.1 dB step for a minimum of -20.0 dB to a maximum of 20.0 dB.
Default value is 0.0 dB

BAL/PAN



This control works as a panpot adjuster, it allows you to control the sound spaciality from left to right.

The parameter has a 0.5 step for a maximum minimum of -12.0 to a maximum of 12.0
Default value is 0

AUX-1

This submenu could be used to specify the behaviour of the current audio source in relation with the logical output AUX-1.



PRE FADER: The fader movement of the channel does not affect the AUX-1 logical output signal.

POST FADER: The fader movement of the channel affects the AUX-1 logical output signal.

PRE FADER ALWAYS ON: The fader movement of the channel does not affect the AUX-1 logical output signal and the source is always forwarded to the AUX-1 logical output, bypassing the ON button of the channel

AUX-2

This submenu could be used to specify the behaviour of the current audio source in relation with the logical output AUX-1.



PRE FADER: The fader movement of the channel does not affect the AUX-2 logical output signal.

POST FADER: The fader movement of the channel affects the AUX-2 logical output signal.

PRE FADER ALWAYS ON: The fader movement of the channel does not affect the AUX-2 logical output signal and the source is always forwarded to the AUX-2 logical output, bypassing the ON button of the channel

BUTTON LIGHT



Between available colors, select the one to be assigned to the following channel buttons:

F1, EQ, PGM, SUB, AUX1, AUX2

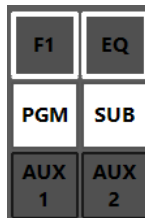

ON



The selection affects all the channels to which this audio source is assigned.

To modify the customizable COLOR 1, COLOR 2, COLOR 3, COLOR 4, go in the menu:

SETUP / GENERAL / LIGHT&DISPLAY

FADER BAR LIGHT

Between available colors, select the one to be assigned to the following channel controls:

ON led, GAIN adjustment

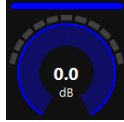

FADER BAR, FADER SLIDER

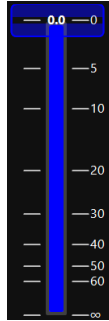

ON MODULE



BY BUTTON & FADER: The airing of the channel needs an interaction of the ON button and a slide up of the fader.

The channel to be considered ON has to be into the following status:

ON = active

SLIDER = higher than $-\infty$

BY FADER: The airing of the channel needs only a slide up of the fader. The OFF status of the channel could only be reached by sliding down the fader and not by ON button pressure.

The channel to be considered ON has to be into the following status:

SLIDER = higher than $-\infty$

BY BUTTON: The airing of the channel needs only an interaction with the ON button:

The channel to be considered ON has to be into the following status:

ON = active

The slider movements will not affect the ON/OFF status of the channel.

ALWAYS ON: The channel is always considered ON. The sliding down of the fader never put the channel in OFF status.

ALWAYS OFF: The channel is always considered OFF.

4.4.3.2.2 TELEPHONE (EQ)

LOW CUT

Low cut (or High Pass filter) is designed to remove all the audio frequencies below the decided one.



Enable: Enable/Disable the application of this Low Cut filter on the audio signal of the current source.

Frequency: All the frequencies below the selected one will be cut off.

BASS / BASS MID / MID / MID HIGH / HIGH

In OXYGEN 1000 and OXYGEN 2000 the equalizer allows a multi-band adjustment of the EQ parameters.

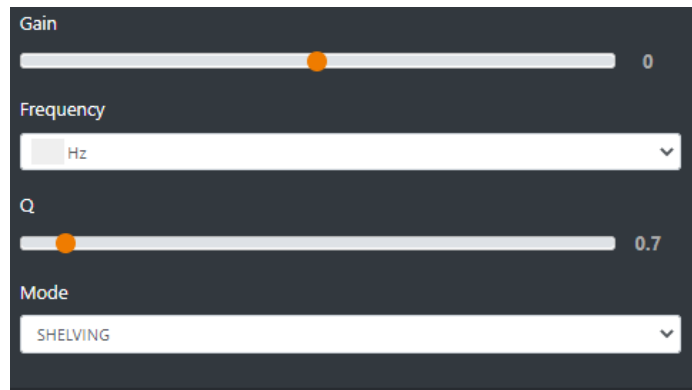

Above the involved parameters to manage: AMPLITUDE, CENTER FREQUENCY, and BANDWIDTH.

GAIN slider controls the amplitude of each band.

FREQUENCY sub-menu can shift and select the central frequency.

Q slider is inversely related to the Bandwidth (which is inversely related to "Q"), Q allows the Bandwidth to be widened or narrowed.

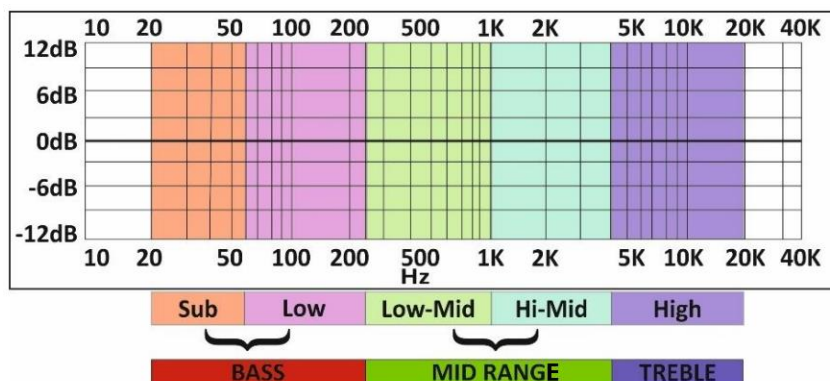

MODE only works in SHELIVING mode for BASS and HIGH (not for BASS-MID, MIDDLE and MID HIGH).

Peak is related to a specific center frequency choosable by FREQUENCY, Q will be applied on the left and on the right of the choosen FREQ. it has to be chosen the center frequency and by the Q factor you can decide to enlarge or to restrict the application curve of the decided gain.

Shelving applies the GAIN on the frequencies before the choosen FREQ (for BASS) and on the frequencies after the choosen FREQ (for HIGH) . The Q factor represents the decreasing slope to be applied from the maximum to the minimum point.

HIGH CUT

High Cut (or Low Pass filter) is designed to remove all the audio frequencies above the selected one.



Enable
OFF

Frequency
16 kHz

Enable: Enable/Disable the application of this High Cut filter on the audio signal of the current source.

Frequency: All the frequencies below the selected one will be cut off.

GENERAL MODE

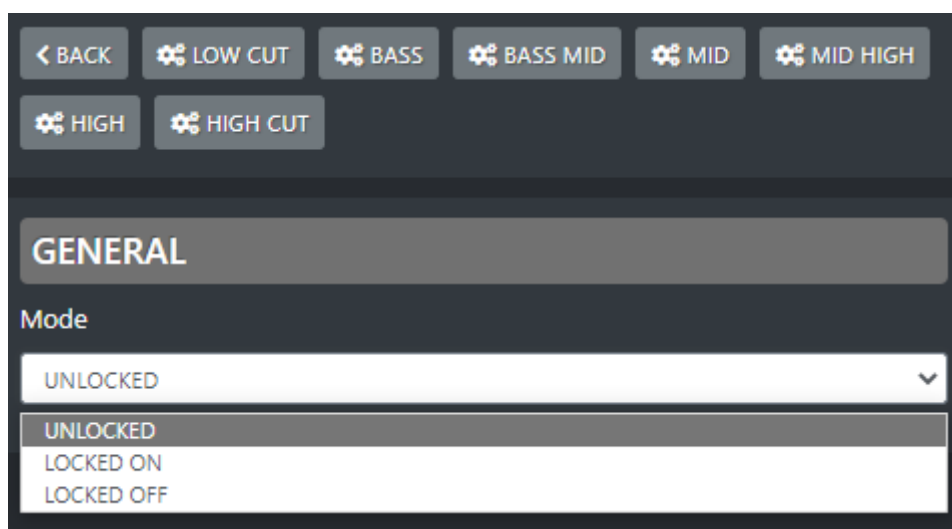

< BACK LOW CUT BASS BASS MID MID MID HIGH HIGH HIGH CUT

GENERAL

Mode
UNLOCKED

UNLOCKED
LOCKED ON
LOCKED OFF

UNLOCKED: This mode always allows to enable/disable EQ by the presure of the related EQ button of the channel.

LOCKED ON: This mode forces the related EQ button of the channel always ON

LOCKED OFF: This mode forces the related EQ button of the channel always OFF

4.4.3.2.3 TELEPHONE (DUCKING)

The DUCKING system allows you to automatically lower the signals of the music while the speakers talk to their MICROPHONES.

For this reason, OXYGEN 1000 and OXYGEN 2000 have been designed with a very useful DUCKING function, which fulfills this need.

In the musical programs when it is mixed with a speech that needs drop music when the anchorman or the guest starts speaking. the background music instantly drops, then it pops right back up again as soon as that person finishes talking. This happens when the ducking effect in action.

Ducking temporarily lowers, or “ducks,” the volume level of a specified audio signal anytime a second specified audio signal is present. In live sound, ducking is commonly used to lower background music anytime a person speaks, then raises it when that person finishes speaking

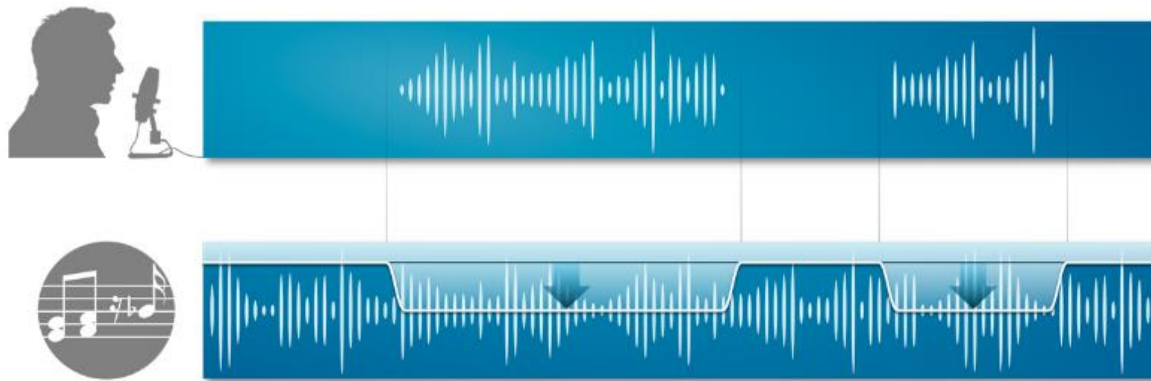

MASTER & SLAVE is the logic on which this functionality is based.

Each console source can be defined as a MASTER source or a SLAVE source.

Usually broadcast microphones are defined as MASTER microphones and other sources in which there is music are defined as SLAVE.

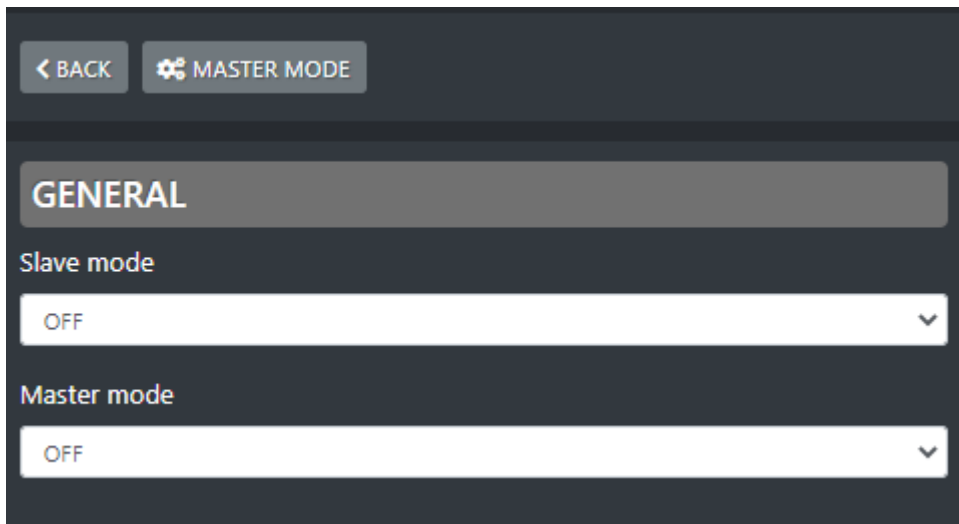

SLAVE MODE:

OFF - in this case the current source will never be lowered when any MASTER source is on air.

ON - in this case the current source will be lowered in level, whenever a MASTER source is on air.

MASTER MODE:

OFF - in this case the current source is not selected as the MASTER source. When it is on air, the sources set as SLAVE sources will not be lowered.

ON - in this case the current source is selected as the MASTER source. When it is on air, the sources set as SLAVE sources will automatically be lowered.

ON/OFF F1: The selected TELCO source works in MASTER MODE only if you press the F1 button of the related channel.

If MASTRER MODE=ON press

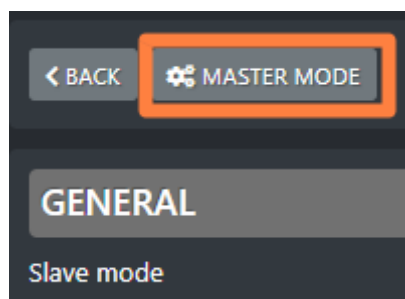

to enter its configuration panel where it will be possible to decide the behavior of all the SLAVE sources, when this MASTER is onair:

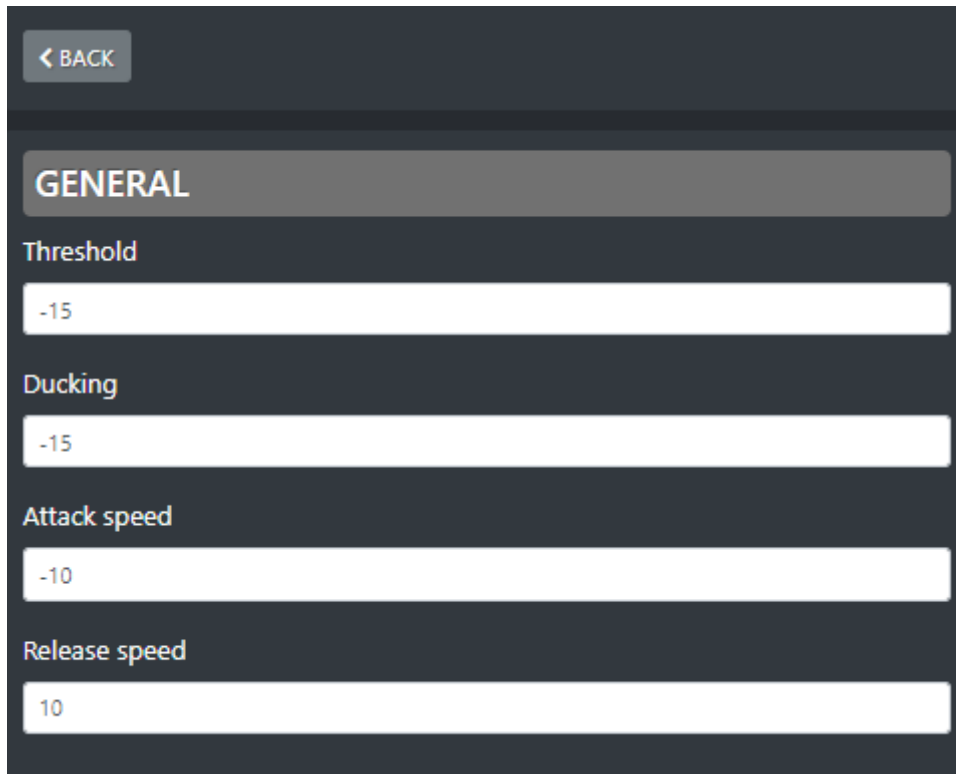

The screenshot shows a dark-themed configuration panel with a '< BACK' button at the top left. Below it is a 'GENERAL' section header. The settings are as follows:

Setting	Value
Threshold	-15
Ducking	-15
Attack speed	-10
Release speed	10

Threshold: minimum audio threshold (dB) relative to this same source. When this audio source reaches this minimum threshold level, DUCKING will be activated for the lowering of all the other sources set as SLAVE.

Ducking: lowering (in dB) performed on all SLAVE sources.

Attack speed: DUCKING activation speed of the current source when its DUCKING activates.

Release speed: speed at which the DUCKING of the current source is deactivated when the same source stops to be on air.

4.4.3.3.1 BLUETOOTH PAIRING

The Bluetooth has two functioning ways:

- Microphone **TX**(Mono)- **RX**(Mono) Interface for telephone communication (GSM call, Skype, FaceTime, WhatsApp, Facebook, Etc.)
- **RX** (Stereo) interface for file/streaming player...

The device is in pairing mode after a fast press (< 1 sec) of the Bluetooth button. It starts to blink in blue color.



search for the **Oxygen 1000D-XXXX** if you have an Oxygen 1000 (or search for the **Oxygen 2000D-XXXX** if you have an Oxygen 2000) in Bluetooth device and connect with it. Once the device is connected the blue light stops blinking.



From OXYGEN REMOTER assign the Bluetooth audio source by selecting it into the desired drop-down menu (for example in 4th channel CH-A)



Press the desired BUS on the channel (in example PGM).



start the audio streaming (music, audio from YouTube/Music Player) or the phone call (Call, Skype, WhatsApp,) from the Bluetooth device.



With a long press of the Bluetooth button , you will disconnect the device.

If you turn on again the Bluetooth in the device and if the device is still associated with the console, it will be automatically paired. You will see a fixed blue light. The console is included **RN52 Bluetooth Audio Module**.

Note: For the module certifications, check this website please:

[HTTPS://WWW.MICROCHIP.COM/WWWPRODUCTS/EN/RN52](https://www.microchip.com/wwwproducts/en/RN52)

4.4.3.3.2 BLUETOOTH (GENERAL)

Telephone source inputs in the console through the RJ11 – TELEPHONE Line connector. The input phone line accepted by this connector is the only analog POTS/PSTN one.

F1 MODE

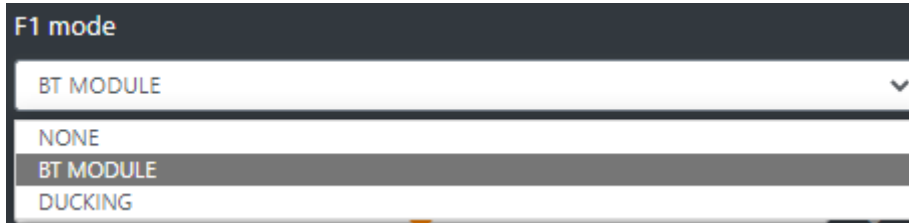

On each console channel you have one **F1** function button. It could be set to work in one of the following 4 modes. The user is free to select the preferred one.

None: the F1 button of the channel to which this BLUETOOTH source is assigned, is disabled.

Bt module: The real HOOK of the phonecall comes from the mobile device HOOK. The F1 button allows the forwarding of the already hooked phonecall to the BLUETOOTH channel. Once a phonecall is already hooked and forwarded to the channel the pressure of the F1 button DROPS the phonecall. The F1 button also blinks while the phone line receives an incoming call.

Ducking: Usually the BLUETOOTH used as an interface for telephone communication has to be set as a MASTER signal. In fact, during a phone call in progress you may want to keep a background music to give it color.

The BLUETOOTH F1 behaviour in DUCKING – MASTER mode depends on the following 2 usage ways

- 5 By applying a countinuitive pressure on F1 button of the channel to which this BLUETOOTH source is assigned, will ENABLE the DUCKING. This will be activated if this BLUETOOTH was set to be a Master source in the console DUCKING rules by the following window:

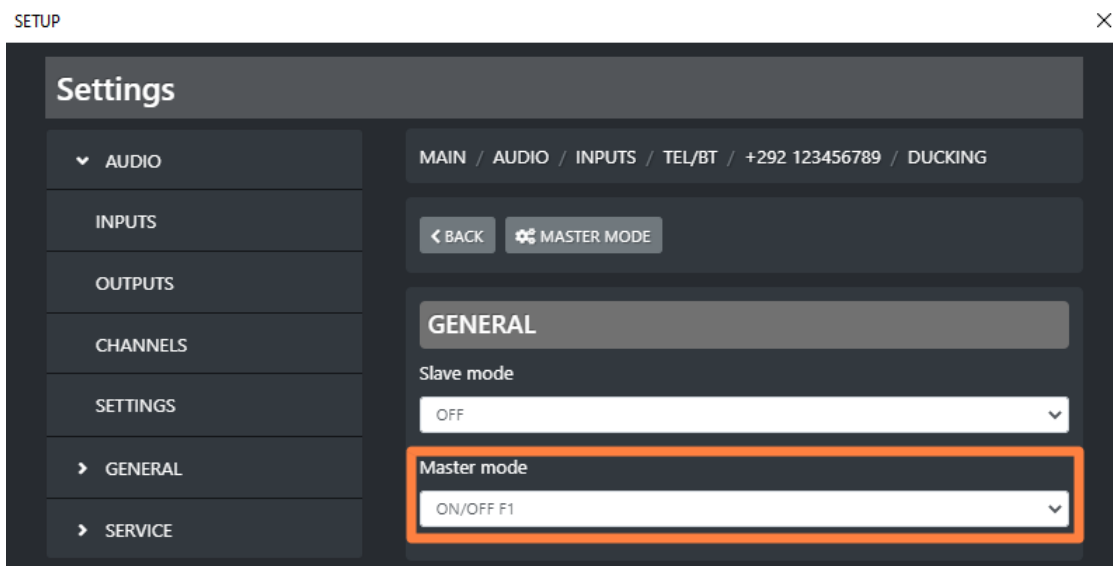

The F1 button to which this BLUETOOTH source is assigned, starts blinking while its DUCKING is currently operating as MASTER.

6 If in the same parameter of the previous picture the Master Mode was set as follow:

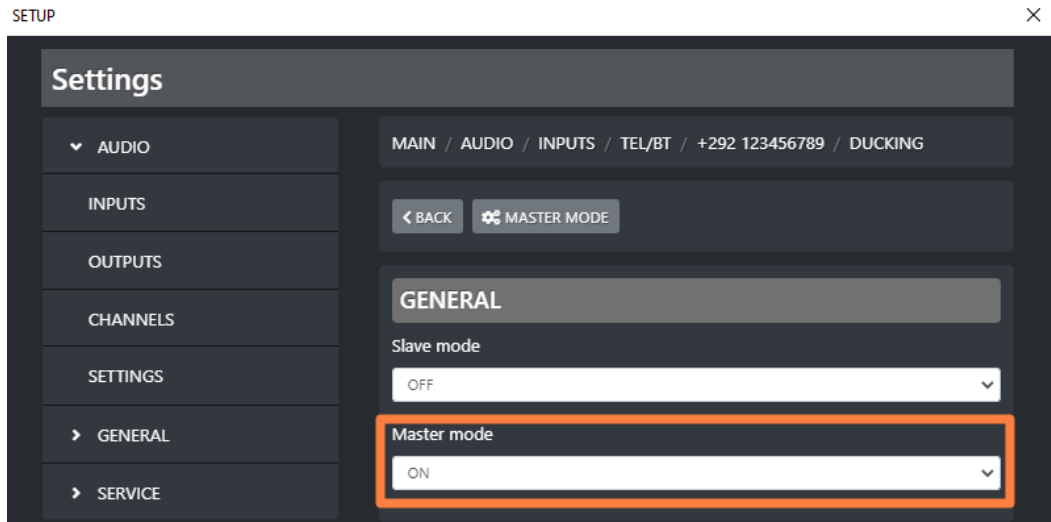

The F1 button to which this BLUETOOTH source is assigned, starts blinking while its DUCKING is currently operating as MASTER.

If you are using the bluetooth device as a file/streaming player, you may need the BLUETOOTH channel set as a DUCKING SLAVE. You should set it as follow:

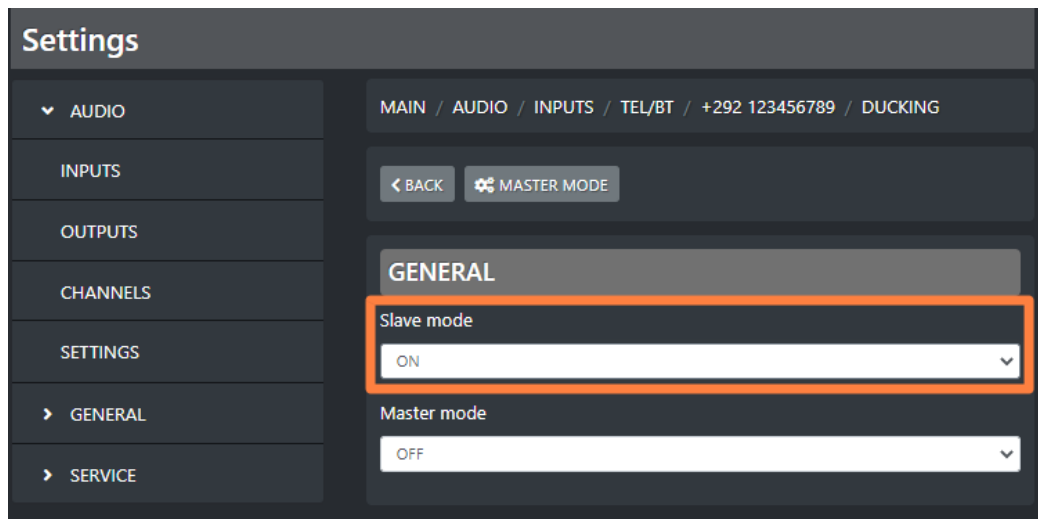

Eq: The F1 button of the channel in which this BLUETOOTH source is assigned to, will ENABLE or DISABLE the equalizer.

GAIN TX

In BLUETOOTH sources (generally in all of the 3 telephone connections: TELCO, TELEPHONE, BLUETOOTH), you should need an additional GAIN to adjust the audio level received by the caller during a phonecall. To set it or to change it you can use this **GAIN TX** controller.



- In the case you are in a private communication with the caller before airing him/her through BLUETOOTH channel with PFL = ON, GAIN TX will be only applied to all the PRIVATE MICS.
- In the case you are ONAIR with the phonecall, with BLUETOOTH channel with PFL = OFF, GAIN TX will be applied to the whole logic BUSS sent to the caller. You can select them by the following BUSS selector of the BLUETOOTH channel:

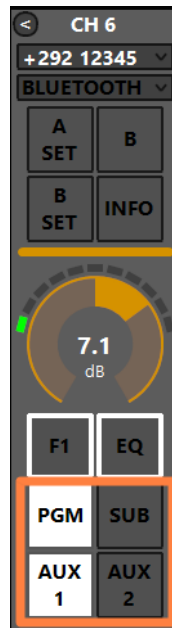

In the previous example, the GAIN TX received by the caller will be applied on the SUM of both PGM and AUX 1 logical BUSS.

CUSTOM NAME



Type in this field a desired customized name for this telco source.
This will allow the director of the program to faster identify this bluetooth source.

On your OXYGEN REMOTER the name of the channel will be displayed on the top of this telco channel:

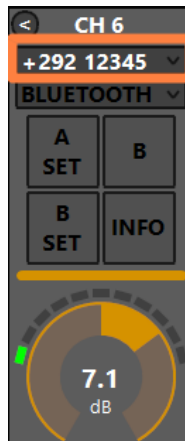

GAIN



This cursor adjusts the gain of the TELCO output signal.
This is the Gain RX, it adjusts the audio level of the caller voice.
The same parameter could be modified directly from the related OXYGEN REMOTER channel:



The parameter has a 0.1 dB step for a minimum of -20.0 dB to a maximum of 20.0 dB.
Default value is 0.0 dB

BAL/PAN



This control works as a panpot adjuster, it allows you to control the sound spaciality from left to right.

The parameter has a 0.5 step for a maximum minimum of -12.0 to a maximum of 12.0
Default value is 0

AUX-1

This submenu could be used to specify the behaviour of the current audio source in relation with the logical output AUX-1.



PRE FADER: The fader movement of the channel does not affect the AUX-1 logical output signal.

POST FADER: The fader movement of the channel affects the AUX-1 logical output signal.

PRE FADER ALWAYS ON: The fader movement of the channel does not affect the AUX-1 logical output signal and the source is always forwarded to the AUX-1 logical output, bypassing the ON button of the channel

AUX-2

This submenu could be used to specify the behaviour of the current audio source in relation with the logical output AUX-1.

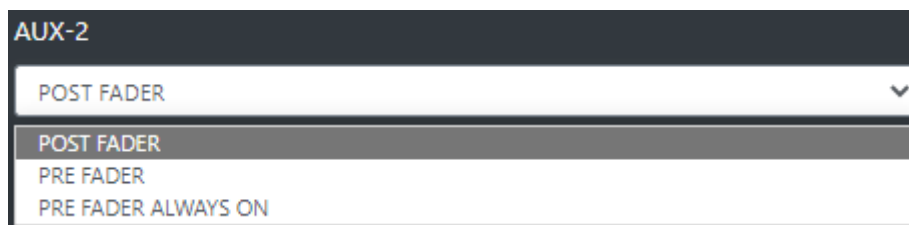

PRE FADER: The fader movement of the channel does not affect the AUX-2 logical output signal.

POST FADER: The fader movement of the channel affects the AUX-2 logical output signal.

PRE FADER ALWAYS ON: The fader movement of the channel does not affect the AUX-2 logical output signal and the source is always forwarded to the AUX-2 logical output, bypassing the ON button of the channel

BUTTON LIGHT



Between available colors, select the one to be assigned to the following channel buttons:

F1, EQ, PGM, SUB, AUX1, AUX2



ON



The selection affects all the channels to which this audio source is assigned.

To modify the customizable COLOR 1, COLOR 2, COLOR 3, COLOR 4, go in the menu:

SETUP / GENERAL / LIGHT&DISPLAY

FADER BAR LIGHT

Between available colors, select the one to be assigned to the following channel controls:

ON led, GAIN adjustment



FADER BAR, FADER SLIDER

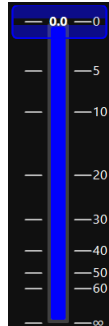

ON MODULE

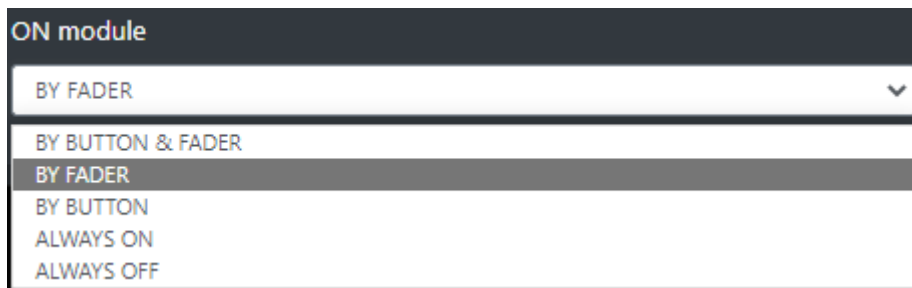

BY BUTTON & FADER: The airing of the channel needs an interaction of the ON button and a slide up of the fader.

The channel to be considered ON has to be into the following status:

ON = active

SLIDER = higher than $-\infty$

BY FADER: The airing of the channel needs only a slide up of the fader. The OFF status of the channel could only be reached by sliding down the fader and not by ON button pressure.

The channel to be considered ON has to be into the following status:

SLIDER = higher than $-\infty$

BY BUTTON: The airing of the channel needs only an interaction with the ON button:

The channel to be considered ON has to be into the following status:

ON = active

The slider movements will not affect the ON/OFF status of the channel.

ALWAYS ON: The channel is always considered ON. The sliding down of the fader never put the channel in OFF status.

ALWAYS OFF: The channel is always considered OFF.

4.4.3.3 BLUETOOTH (EQ)

LOW CUT

Low cut (or High Pass filter) is designed to remove all the audio frequencies below the decided one.



Enable: Enable/Disable the application of this Low Cut filter on the audio signal of the current source.

Frequency: All the frequencies below the selected one will be cut off.

BASS / BASS MID / MID / MID HIGH / HIGH

In OXYGEN 1000 and OXYGEN 2000 the equalizer allows a multi-band adjustment of the EQ parameters.

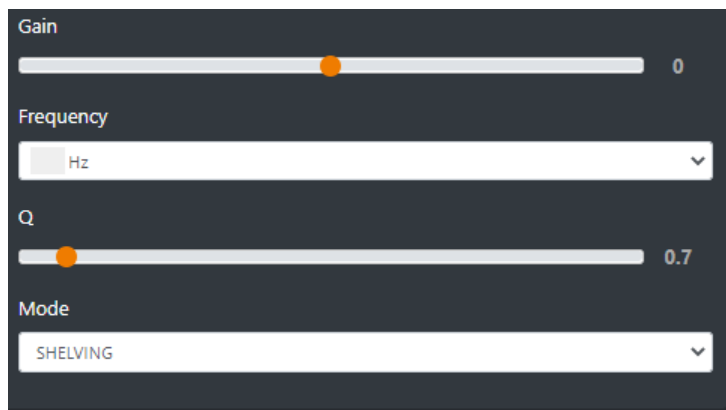

Above the involved parameters to manage: AMPLITUDE, CENTER FREQUENCY, and BANDWIDTH.

GAIN slider controls the amplitude of each band.

FREQUENCY sub-menu can shift and select the central frequency.

Q slider is inversely related to the Bandwidth (which is inversely related to "Q"), Q allows the Bandwidth to be widened or narrowed.

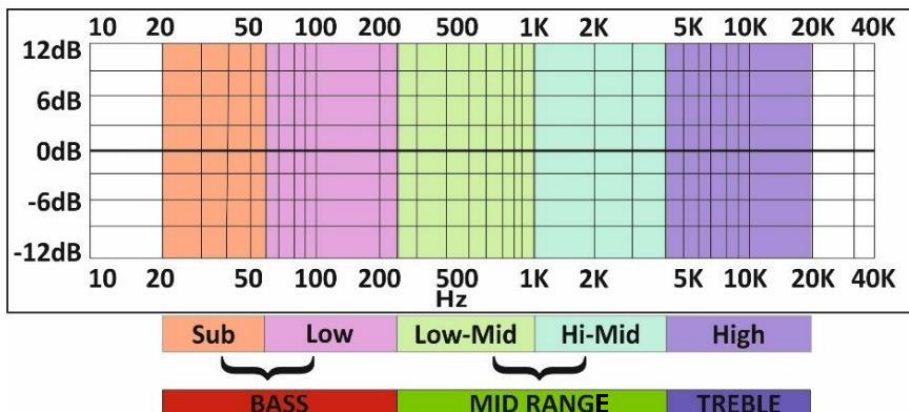

MODE only works in SHELVING mode for BASS and HIGH (not for BASS-MID, MIDDLE and MID HIGH).

Peak is related to a specific center frequency choosable by FREQUENCY, Q will be applied on the left and on the right of the choosen FREQ. it has to be chosen the center frequency and by the Q factor you can decide to enlarge or to restrict the application curve of the decided gain.

Shelving applies the GAIN on the frequencies before the choosen FREQ (for BASS) and on the frequencies after the choosen FREQ (for HIGH) . The Q factor represents the decreasing slope to be applied from the maximum to the minimum point.

HIGH CUT

High Cut (or Low Pass filter) is designed to remove all the audio frequencies above the selected one.

Enable: Enable/Disable the application of this High Cut filter on the audio signal of the current source.

Frequency: All the frequencies below the selected one will be cut off.

GENERAL MODE

UNLOCKED: This mode always allows to enable/disable EQ by the presure of the related EQ button of the channel.

LOCKED ON: This mode forces the related EQ button of the channel always ON

LOCKED OFF: This mode forces the related EQ button of the channel always OFF

4.4.3.3.4 BLUETOOTH (DUCKING)

The DUCKING system allows you to automatically lower the signals of the music while the speakers talk to their MICROPHONES.

For this reason, OXYGEN 1000 and OXYGEN 2000 have been designed with a very useful DUCKING function, which fulfills this need.

In the musical programs when it is mixed with a speech that needs drop music when the anchorman or the guest starts speaking. the background music instantly drops, then it pops right back up again as soon as that person finishes talking. This happens when the ducking effect in action.

Ducking temporarily lowers, or “ducks,” the volume level of a specified audio signal anytime a second specified audio signal is present. In live sound, ducking is commonly used to lower background music anytime a person speaks, then raises it when that person finishes speaking



MASTER & SLAVE is the logic on which this functionality is based.

Each console source can be defined as a MASTER source or a SLAVE source.

Usually broadcast microphones are defined as MASTER microphones and other sources in which there is music are defined as SLAVE.

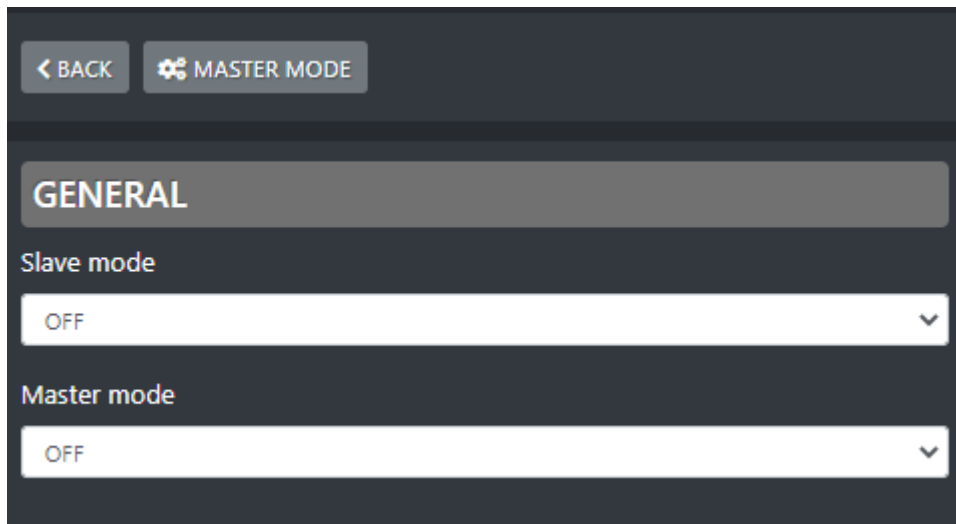
**SLAVE MODE:**

OFF - in this case the current source will never be lowered when any MASTER source is on air.

ON - in this case the current source will be lowered in level, whenever a MASTER source is on air.

MASTER MODE:

OFF - in this case the current source is not selected as the MASTER source. When it is on air, the sources set as SLAVE sources will not be lowered.

ON - in this case the current source is selected as the MASTER source. When it is on air, the sources set as SLAVE sources will automatically be lowered.

ON/OFF F1: The selected BLUETOOTH source works in MASTER MODE only if you press the F1 button of the related channel.

If MASTRER MODE=ON press

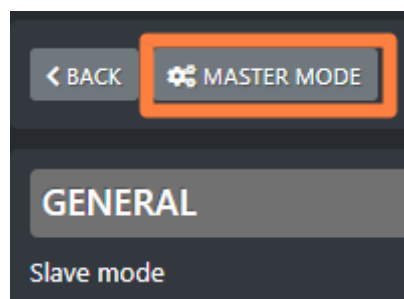

to enter its configuration panel where it will be possible to decide the behavior of all the SLAVE sources, when this MASTER is onair:

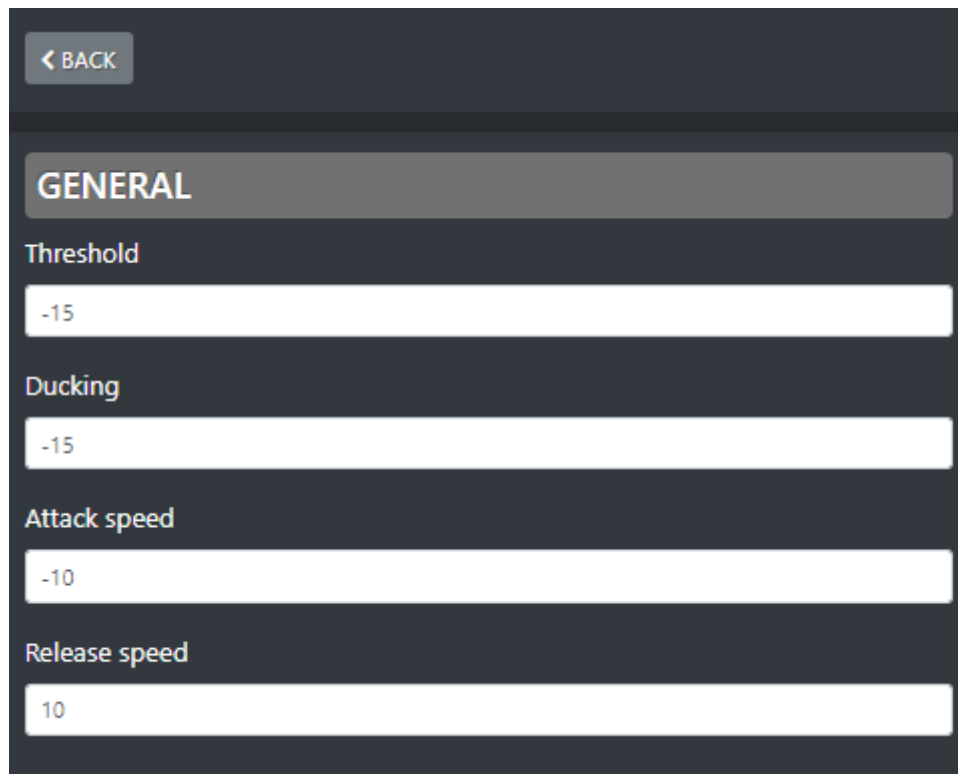

The screenshot shows a dark-themed configuration panel with a '← BACK' button at the top left. Below it is a 'GENERAL' section header. The panel contains four settings, each with a label and a corresponding input field:

- Threshold:** Input field contains '-15'
- Ducking:** Input field contains '-15'
- Attack speed:** Input field contains '-10'
- Release speed:** Input field contains '10'

Threshold: minimum audio threshold (dB) relative to this same source. When this audio source reaches this minimum threshold level, DUCKING will be activated for the lowering of all the other sources set as SLAVE.

Ducking: lowering (in dB) performed on all SLAVE sources.

Attack speed: DUCKING activation speed of the current source when its DUCKING activates.

Release speed: speed at which the DUCKING of the current source is deactivated when the same source stops to be on air.

4.4.4.1 DIGITAL

With regard to digital sources, OXYGEN 1000 and OXYGEN 2000 can be purchased with the 2 following possible different digital output modes:

- If the console is purchased with the DANTE option, there will be no possibility of USB digital inputs.

If the option is present, the interested RJ45 connector AOIP will be the following one:

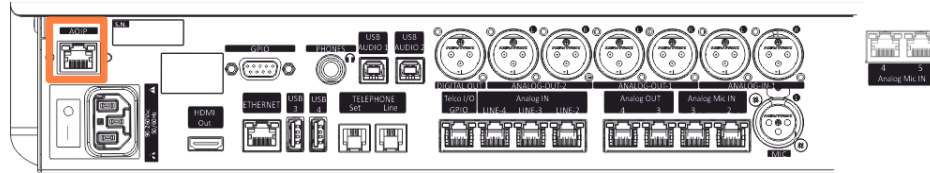

DANTE AUDIO-OVER-IP CONNECTIVITY (Optional)

Dante option (compliant with AES67) provides an Ethernet connection for 8 Stereo Input and 8 Stereo Output, with independent and dedicated Level Control and Sample Rate Conversion.

[HTTPS://DEV.AUDINATE.COM/GA/DANTE-CONTROLLER/USERGUIDE/PDF/LATEST/AUD-MAN-DANTECONTROLLER-4.4.X-V1.0.PDF](https://dev.audinate.com/ga/dante-controller/userguide/pdf/latest/aud-man-dantecontroller-4.4.x-v1.0.pdf)

- On the other hand, if the console is not purchased with the DANTE option, the USB digital inputs will work.

CONSOLE WITHOUT DANTE OPTION

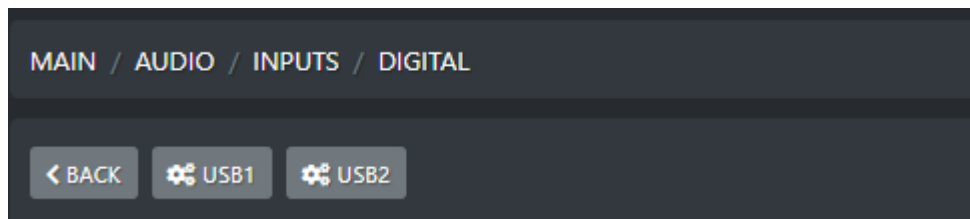

CONSOLE WITH DANTE OPTION

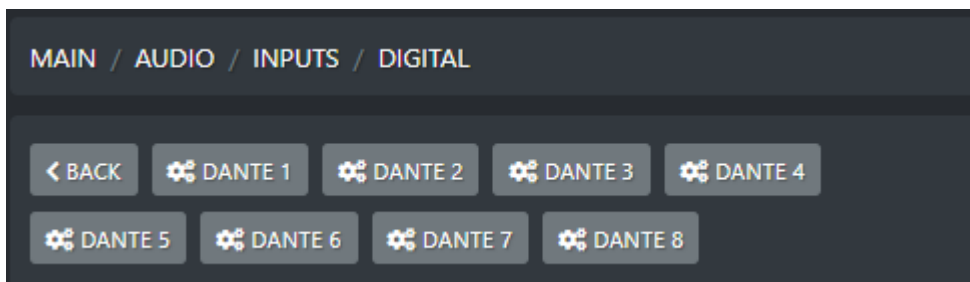

4.4.4.1.1 USB1 / USB 2 (GENERAL)

MODE

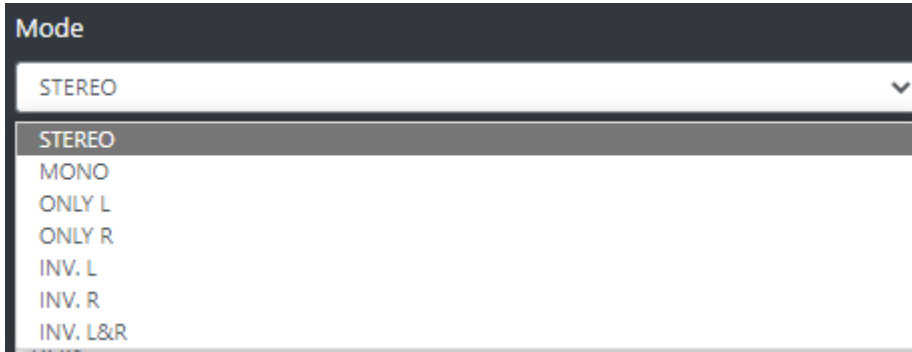

Below an explication of all the USB stereo modes:

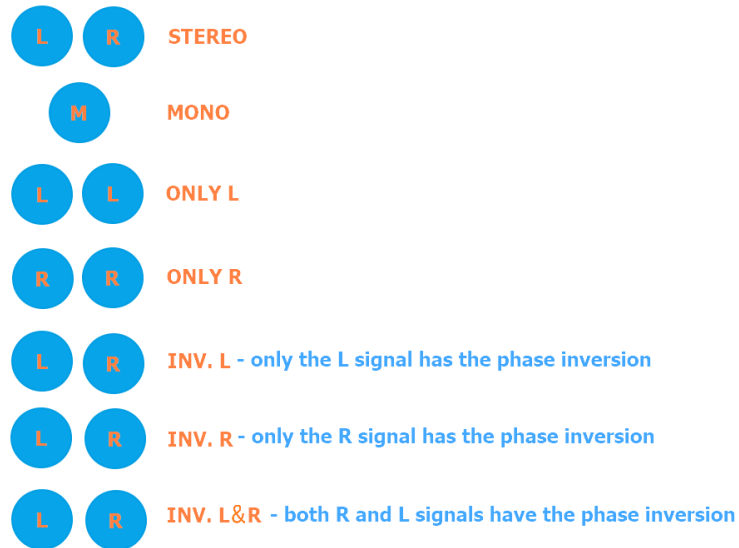

F1 MODE

On each console channel you have one **F1** function button. It could be set to work in one of the following 4 modes. The user is free to select the preferred one.



None: the F1 button of the channel to which this USB source is assigned, is disabled.

Ducking: Usually the USB sources in the DUCKING rules work as SLAVE signals, so the F1 should not be used because the USB channels are set as follow:

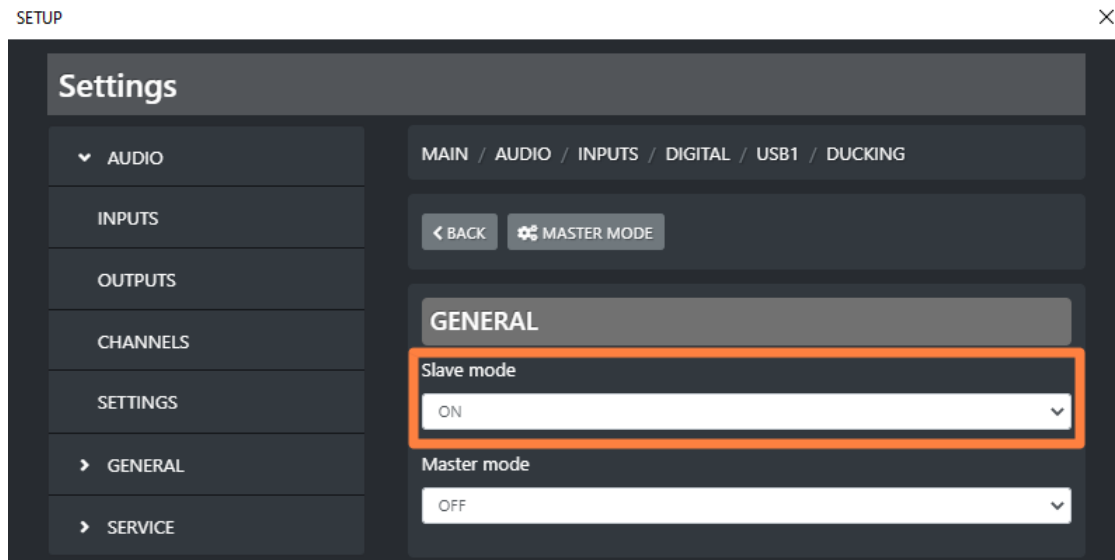

For some special circumstances you may need the USB channel set as a DUCKING MASTER, and the behaviour of the related F1 button in DUCKING mode depends on the following 2 usage ways:

1. By applying a countinuitive pressure on F1 button of the channel to which this USB source is assigned, will ENABLE the DUCKING. This will be activated if this USB was set to be a Master source in the console DUCKING rules by the following window:

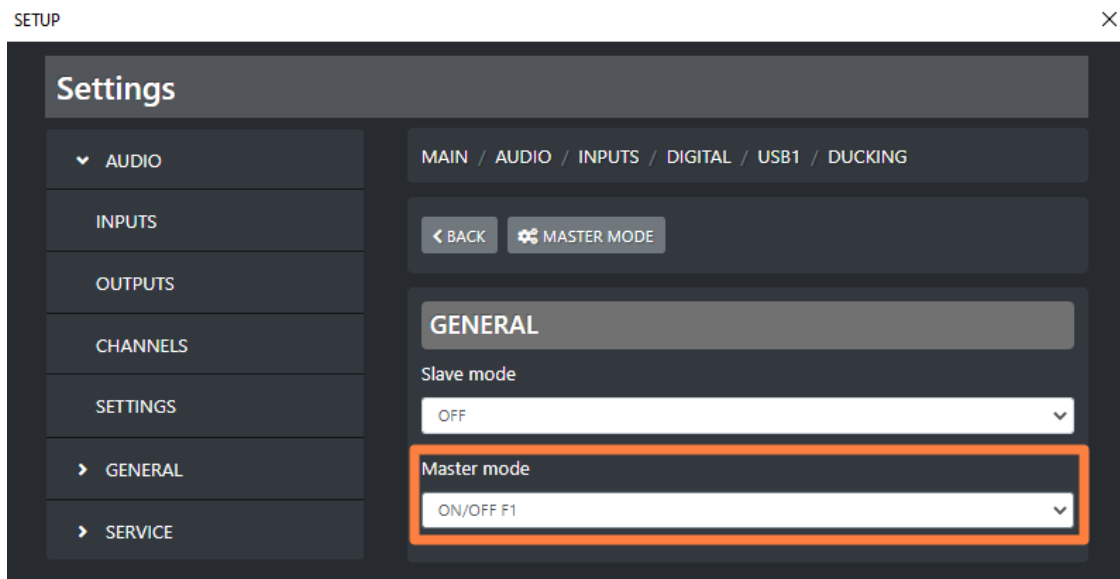

- If in the same parameter of the previous picture the Master Mode was set as follow:

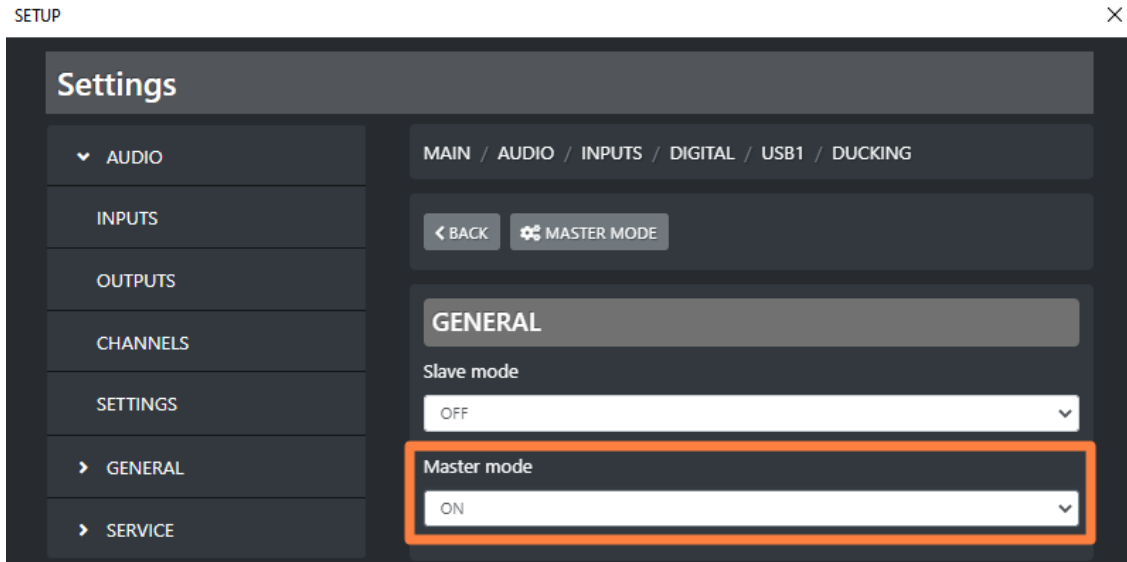

The F1 button to which this USB source is assigned, starts blinking while its DUCKING is currently operating as MASTER.

Eq: The F1 button of the channel in which this USB source is assigned to, will ENABLE or DISABLE the equalizer.

CUSTOM NAME

Type in this field a desired customized name for this stereo source.

This will allow the director of the program to faster identify this stereo source.



On your OXYGEN REMOTER the name of the channel will be displayed on the top of this stereo channel:

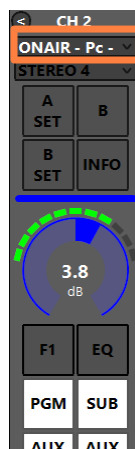

GAIN



This cursor adjusts the STEREO source GAIN.

The same parameter could be modified directly from the related OXYGEN REMOTER channel:

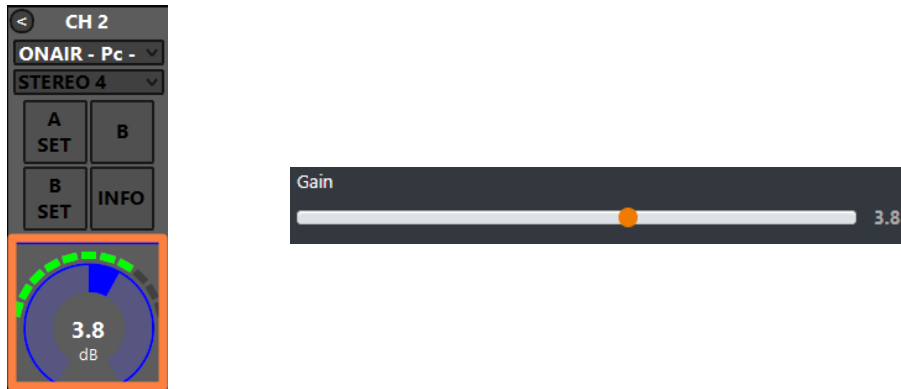

The parameter has a 0.1 dB step for a minimum of -20.0 dB to a maximum of 20.0 dB. Default value is 0.0 dB

BAL/PAN



This control works as a panpot adjuster, it allows you to control the sound spaciality from left to right.

The parameter has a 0.5 step for a maximum minimum of -12.0 to a maximum of 12.0 Default value is 0

AUX-1

This submenu could be used to specify the behaviour of the current audio source in relation with the logical output AUX-1.



PRE FADER: The fader movement of the channel does not affect the AUX-1 logical output signal.

POST FADER: The fader movement of the channel affects the AUX-1 logical output signal.

PRE FADER ALWAYS ON: The fader movement of the channel does not affect the AUX-1 logical output signal and the source is always forwarded to the AUX-1 logical output, bypassing the ON button of the channel

AUX-2

This submenu could be used to specify the behaviour of the current audio source in relation with the logical output AUX-1.

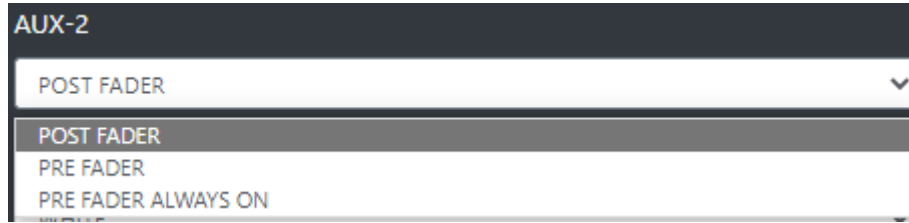

PRE FADER: The fader movement of the channel does not affect the AUX-2 logical output signal.

POST FADER: The fader movement of the channel affects the AUX-2 logical output signal.

PRE FADER ALWAYS ON: The fader movement of the channel does not affect the AUX-2 logical output signal and the source is always forwarded to the AUX-2 logical output, bypassing the ON button of the channel

BUTTON LIGHT



Between available colors, select the one to be assigned to the following channel buttons:

F1, EQ, PGM, SUB, AUX1, AUX2



ON



The selection affects all the channels to which this audio source is assigned.

To modify the customizable COLOR 1, COLOR 2, COLOR 3, COLOR 4, go in the menu:

SETUP / GENERAL / LIGHT&DISPLAY

FADER BAR LIGHT

Between available colors, select the one to be assigned to the following channel controls:

ON led, GAIN adjustment



FADER BAR, FADER SLIDER

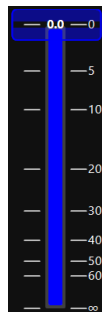

ON MODULE

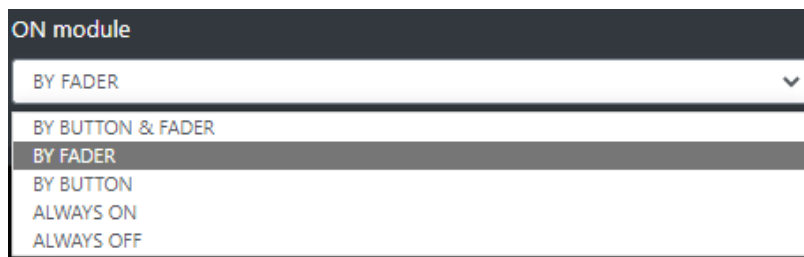

BY BUTTON & FADER: The airing of the channel needs an interaction of the ON button and a slide up of the fader.

The channel to be considered ON has to be into the following status:

ON = active

SLIDER = higher than -∞

BY FADER: The airing of the channel needs only a slide up of the fader. The OFF status of the channel could only be reached by sliding down the fader and not by ON button pressure.

The channel to be considered ON has to be into the following status:

SLIDER = higher than -∞

BY BUTTON: The airing of the channel needs only an interaction with the ON button:

The channel to be considered ON has to be into the following status:

ON = active

The slider movements will not affect the ON/OFF status of the channel.

ALWAYS ON: The channel is always considered ON. The sliding down of the fader never put the channel in OFF status.

ALWAYS OFF: The channel is always considered OFF.

4.4.4.1.2 USB1 / USB2 (EQ)

LOW CUT

Low cut (or High Pass filter) is designed to remove all the audio frequencies below the decided one.



Enable: Enable/Disable the application of this Low Cut filter on the audio signal of the current source.

Frequency: All the frequencies below the selected one will be cut off.

BASS / BASS MID / MID / MID HIGH / HIGH

In OXYGEN 1000 and OXYGEN 2000 the equalizer allows a multi-band adjustment of the EQ parameters.



Above the involved parameters to manage: AMPLITUDE, CENTER FREQUENCY, and BANDWIDTH.

GAIN slider controls the amplitude of each band.

FREQUENCY sub-menu can shift and select the central frequency.

Q slider is inversely related to the Bandwidth (which is inversely related to "Q"), Q allows the Bandwidth to be widened or narrowed.

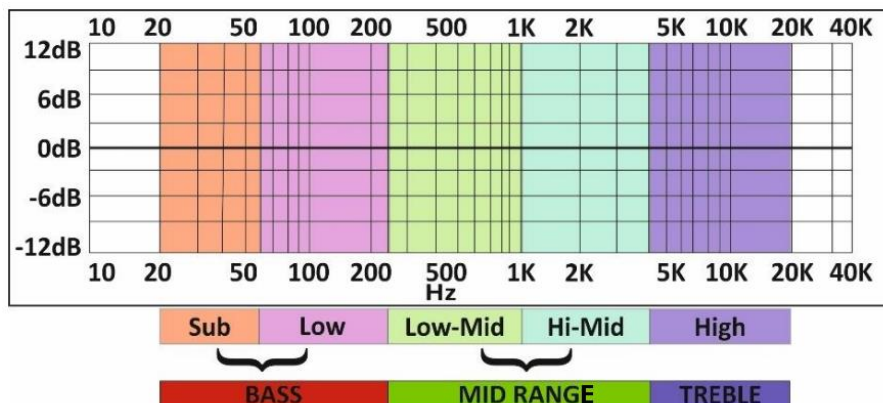

MODE only works in SHELIVING mode for BASS and HIGH (not for BASS-MID, MIDDLE and MID HIGH).

Peak is related to a specific center frequency choosable by FREQUENCY, Q will be applied on the left and on the right of the choosen FREQ. it has to be chosen the center frequency and by the Q factor you can decide to enlarge or to restrict the application curve of the decided gain.

Shelving applies the GAIN on the frequencies before the choosen FREQ (for BASS) and on the frequencies after the choosen FREQ (for HIGH) . The Q factor represents the decreasing slope to be applied from the maximum to the minimum point.

HIGH CUT

High Cut (or Low Pass filter) is designed to remove all the audio frequencies above the selected one.



Enable: Enable/Disable the application of this High Cut filter on the audio signal of the current source.

Frequency: All the frequencies below the selected one will be cut off.

GENERAL MODE

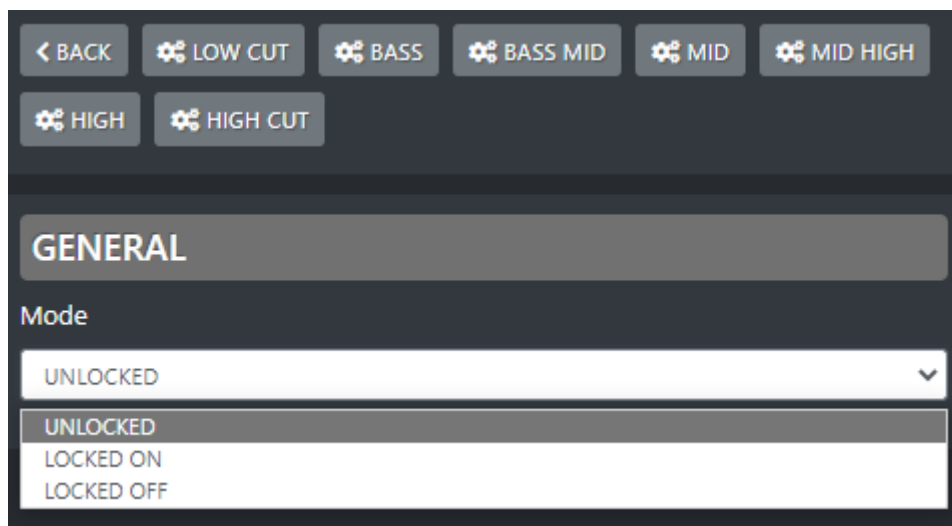

UNLOCKED: This mode always allows to enable/disable EQ by the pressure of the related EQ button of the channel.

LOCKED ON: This mode forces the related EQ button of the channel always ON

LOCKED OFF: This mode forces the related EQ button of the channel always OFF

4.4.4.1.3 USB1 / USB2 (DUCKING)

The DUCKING system allows you to automatically lower the signals of the music while the speakers talk to their MICROPHONES.

For this reason, OXYGEN 1000 and OXYGEN 2000 have been designed with a very useful DUCKING function, which fulfills this need.

In the musical programs when it is mixed with a speech that needs drop music when the anchorman or the guest starts speaking. the background music instantly drops, then it pops right back up again as soon as that person finishes talking. This happens when the ducking effect in action.

Ducking temporarily lowers, or “ducks,” the volume level of a specified audio signal anytime a second specified audio signal is present. In live sound, ducking is commonly used to lower background music anytime a person speaks, then raises it when that person finishes speaking



MASTER & SLAVE is the logic on which this functionality is based.

Each console source can be defined as a MASTER source or a SLAVE source.

Usually broadcast microphones are defined as MASTER microphones and other sources in which there is music are defined as SLAVE.

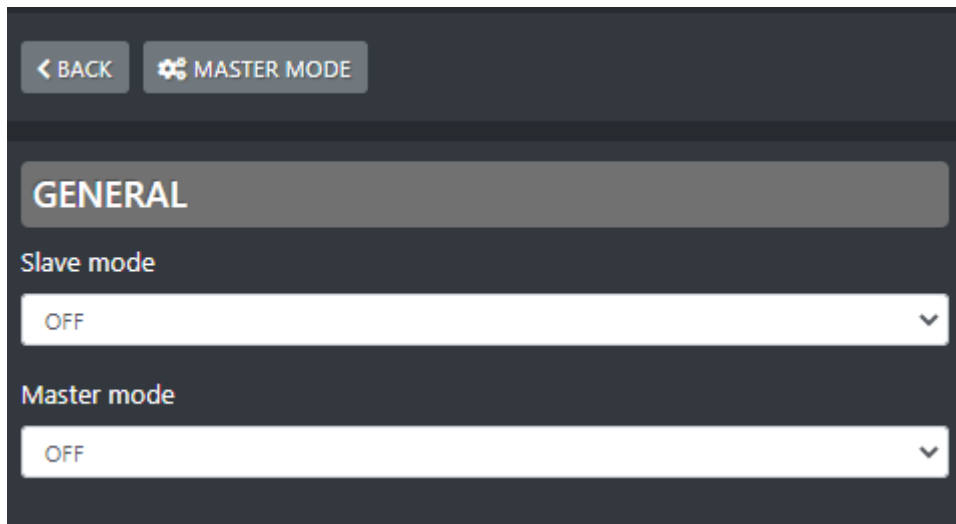
**SLAVE MODE:**

In the case of a UBS stereo source the DUCKING MODE is suggested to be the SLAVE one. Usually it is a source with Music or Background sounds.

OFF - in this case the current source will never be lowered when any MASTER source is on air.

ON - in this case the current source will be lowered in level, whenever a MASTER source is on air.

MASTER MODE:

For some special circumstances you may need the USB channel set as MASTER.

OFF - in this case the current source is not selected as the MASTER source. When it is on air, the sources set as SLAVE sources will not be lowered.

ON - in this case the current source is selected as the MASTER source. When it is on air, the sources set as SLAVE sources will automatically be lowered.

4.4.4.2.1 DANTE 1 / DANTE 2 / DANTE 3 / DANTE 4 / DANTE 5 / DANTE 6 / DANTE 7 / DANTE 8 (GENERAL)

MODE

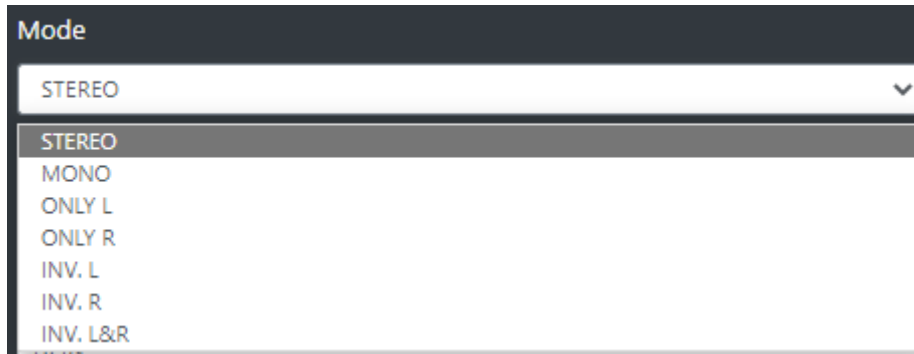

Below an explication of all the DANTE stereo modes:

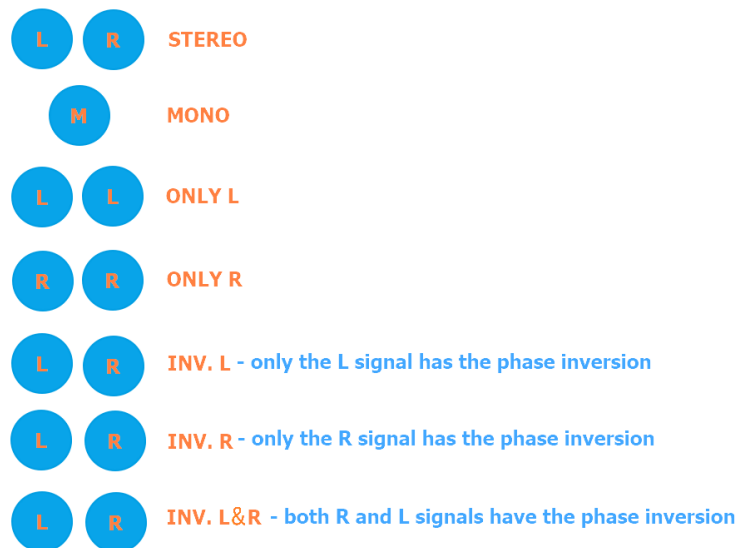

F1 MODE

On each console channel you have one **F1** function button. It could be set to work in one of the following 4 modes. The user is free to select the preferred one.



None: the F1 button of the channel to which this DANTE source is assigned, is disabled.

Ducking: Usually the DANTE sources in the DUCKING rules work as SLAVE signals, so the F1 should not be used because the DANTE channels are set as follow:

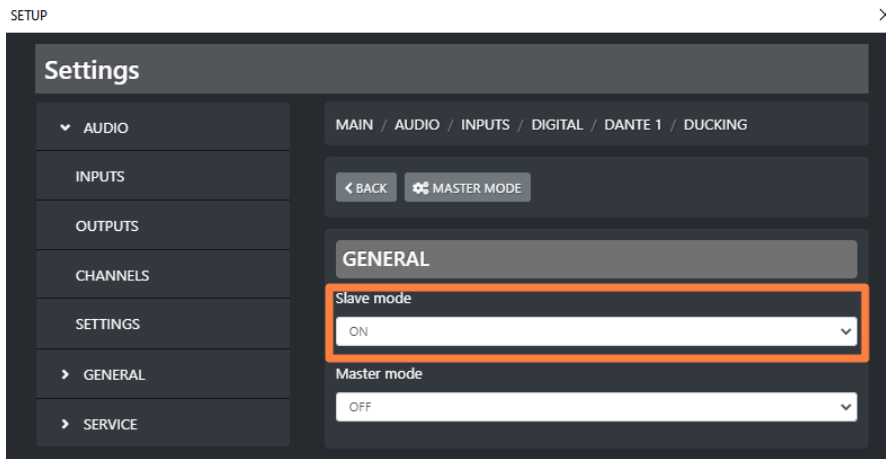

For some special circumstances you may need the DANTE channel set as a DUCKING MASTER, and the behaviour of the related F1 button in DUCKING mode depends on the following 2 usage ways:

1. By applying a countinulative pressure on F1 button of the channel to which this DANTE source is assigned, will ENABLE the DUCKING. This will be activated if this DANTE was set to be a Master source in the console DUCKING rules by the following window:

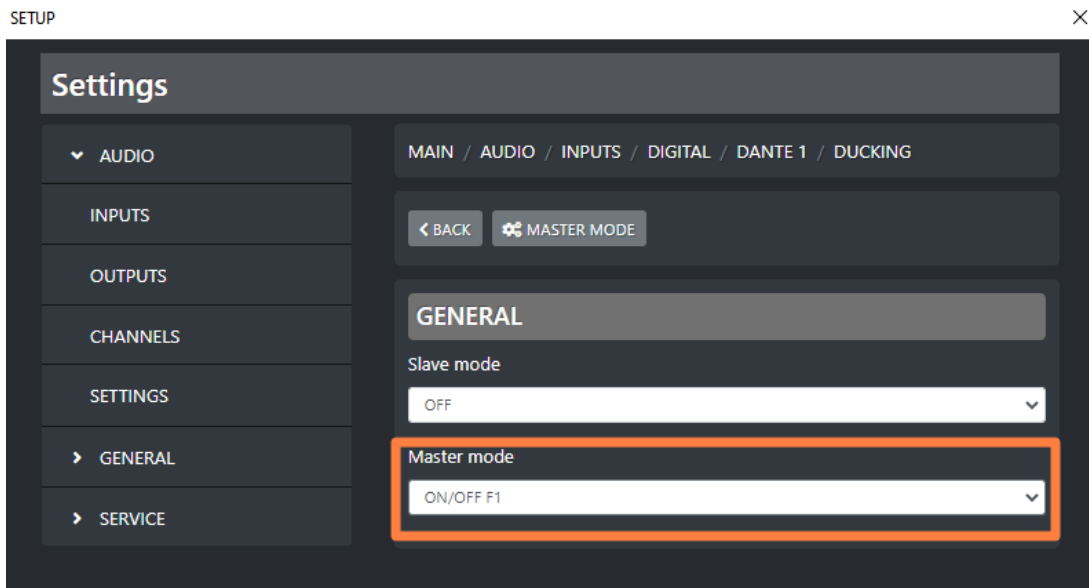

- If in the same parameter of the previous picture the Master Mode was set as follow:

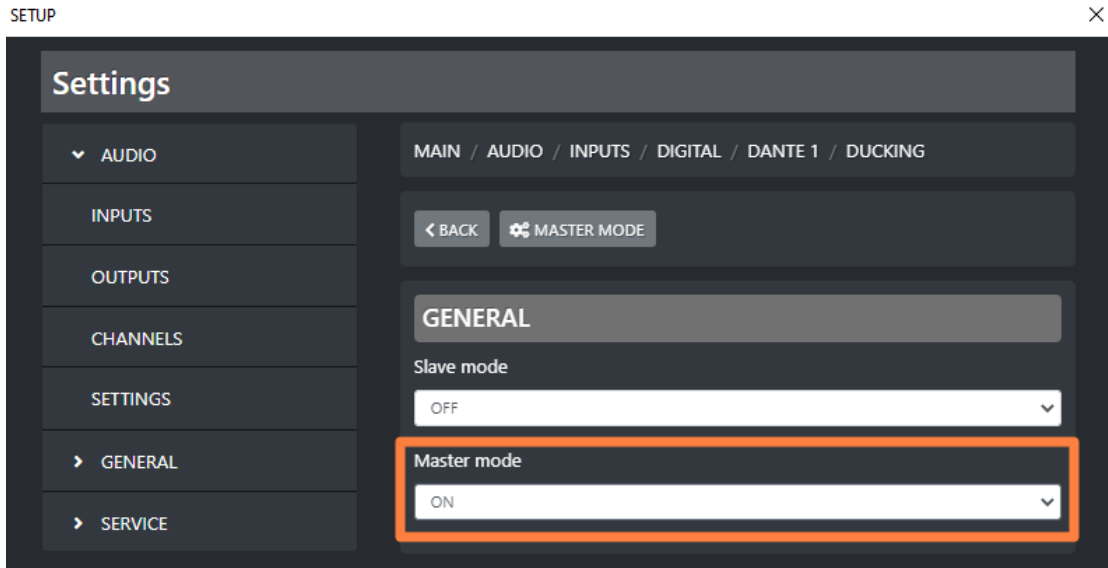

The F1 button to which this DANTE source is assigned, starts blinking while its DUCKING is currently operating as MASTER.

Eq: The F1 button of the channel in which this DANTE source is assigned to, will ENABLE or DISABLE the equalizer.

CUSTOM NAME

Type in this field a desired customized name for this DANTE stereo source. This will allow the director of the program to faster identify this stereo source.



On your OXYGEN REMOTER the name of the channel will be displayed on the top of this DANTE channel:

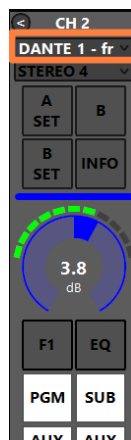

GAIN



This cursor adjusts the DANTE source GAIN.

The same parameter could be modified directly from the related OXYGEN REMOTER channel:

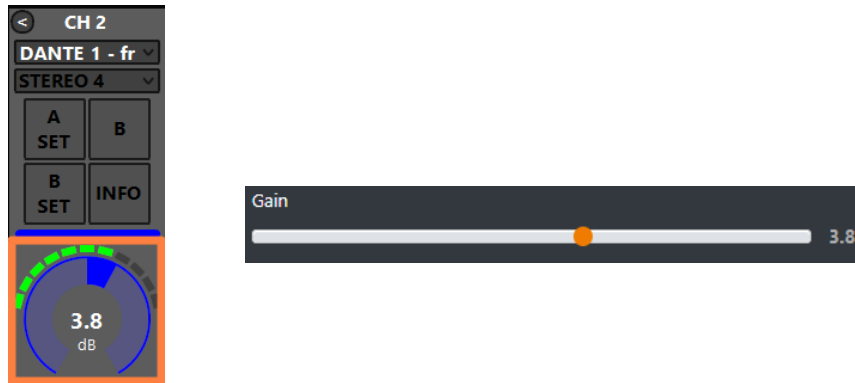

The parameter has a 0.1 dB step for a minimum of -20.0 dB to a maximum of 20.0 dB.
Default value is 0.0 dB

BAL/PAN



This control works as a panpot adjuster, it allows you to control the sound spaciality from left to right.

The parameter has a 0.5 step for a maximum minimum of -12.0 to a maximum of 12.0
Default value is 0

AUX-1

This submenu could be used to specify the behaviour of the current audio source in relation with the logical output AUX-1.



PRE FADER: The fader movement of the channel does not affect the AUX-1 logical output signal.

POST FADER: The fader movement of the channel affects the AUX-1 logical output signal.

PRE FADER ALWAYS ON: The fader movement of the channel does not affect the AUX-1 logical output signal and the source is always forwarded to the AUX-1 logical output, bypassing the ON button of the channel

AUX-2

This submenu could be used to specify the behaviour of the current audio source in relation with the logical output AUX-1.

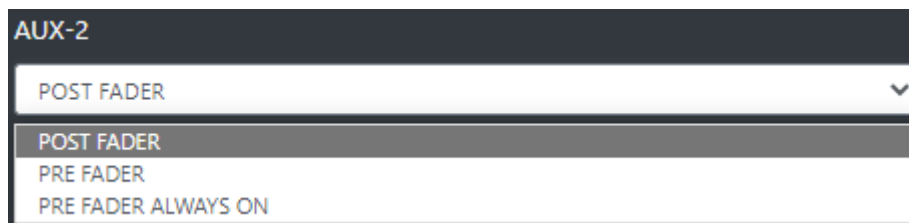

PRE FADER: The fader movement of the channel does not affect the AUX-2 logical output signal.

POST FADER: The fader movement of the channel affects the AUX-2 logical output signal.

PRE FADER ALWAYS ON: The fader movement of the channel does not affect the AUX-2 logical output signal and the source is always forwarded to the AUX-2 logical output, bypassing the ON button of the channel

BUTTON LIGHT



Between available colors, select the one to be assigned to the following channel buttons:

F1, EQ, PGM, SUB, AUX1, AUX2

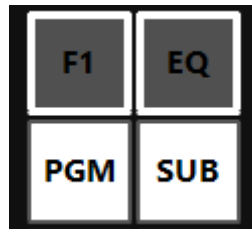

ON



The selection affects all the channels to which this audio source is assigned.

To modify the customizable COLOR 1, COLOR 2, COLOR 3, COLOR 4, go in the menu:

SETUP / GENERAL / LIGHT&DISPLAY

FADER BAR LIGHT

Between available colors, select the one to be assigned to the following channel controls:

ON led, GAIN adjustment

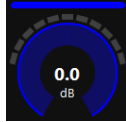

FADER BAR, FADER SLIDER

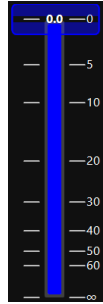

ON MODULE



BY BUTTON & FADER: The airing of the channel needs an interaction of the ON button and a slide up of the fader.

The channel to be considered ON has to be into the following status:

ON = active

SLIDER = higher than $-\infty$

BY FADER: The airing of the channel needs only a slide up of the fader. The OFF status of the channel could only be reached by sliding down the fader and not by ON button pressure.

The channel to be considered ON has to be into the following status:

SLIDER = higher than $-\infty$

BY BUTTON: The airing of the channel needs only an interaction with the ON button:

The channel to be considered ON has to be into the following status:

ON = active

The slider movements will not affect the ON/OFF status of the channel.

ALWAYS ON: The channel is always considered ON. The sliding down of the fader never put the channel in OFF status.

ALWAYS OFF: The channel is always considered OFF.

4.4.4.2.2 DANTE 1 / DANTE 2 / DANTE 3 / DANTE 4 / DANTE 5 / DANTE 6 / DANTE 7 / DANTE 8 (EQ)

LOW CUT

Low cut (or High Pass filter) is designed to remove all the audio frequencies below the decided one.



Enable: Enable/Disable the application of this Low Cut filter on the audio signal of the current source.

Frequency: All the frequencies below the selected one will be cut off.

BASS / BASS MID / MID / MID HIGH / HIGH

In OXYGEN 1000 and OXYGEN 2000 the equalizer allows a multi-band adjustment of the EQ parameters.

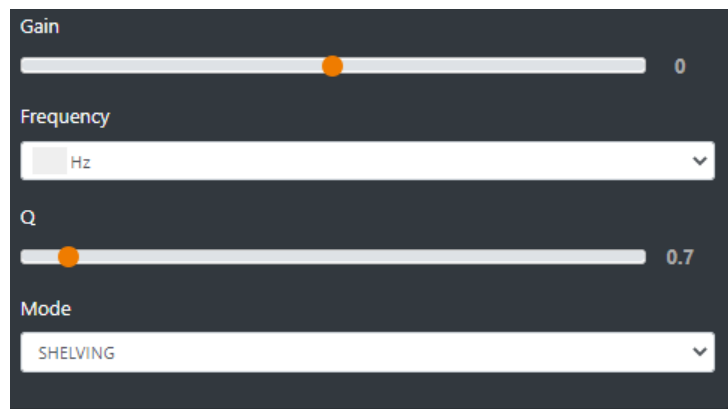

Above the involved parameters to manage: AMPLITUDE, CENTER FREQUENCY, and BANDWIDTH.

GAIN slider controls the amplitude of each band.

FREQUENCY sub-menu can shift and select the central frequency.

Q slider is inversely related to the Bandwidth (which is inversely related to "Q"), Q allows the Bandwidth to be widened or narrowed.

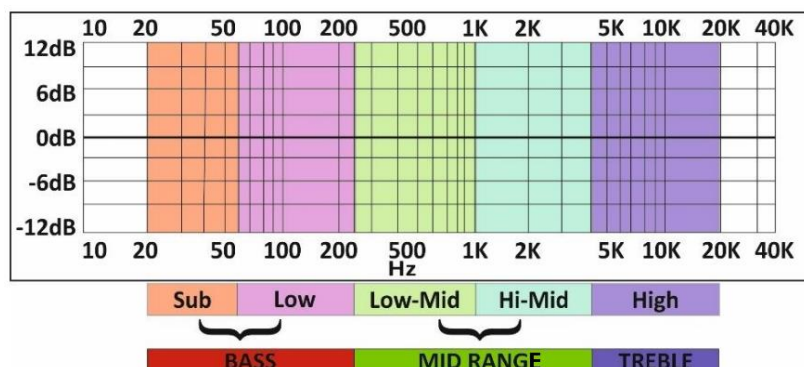

MODE only works in SHELIVING mode for BASS and HIGH (not for BASS-MID, MIDDLE and MID HIGH).

Peak is related to a specific center frequency choosable by FREQUENCY, Q will be applied on the left and on the right of the choosen FREQ. it has to be chosen the center frequency and by the Q factor you can decide to enlarge or to restrict the application curve of the decided gain.

Shelving applies the GAIN on the frequencies before the choosen FREQ (for BASS) and on the frequencies after the choosen FREQ (for HIGH) . The Q factor represents the decreasing slope to be applied from the maximum to the minimum point.

HIGH CUT

High Cut (or Low Pass filter) is designed to remove all the audio frequencies above the selected one.



Enable
OFF

Frequency
16 kHz

Enable: Enable/Disable the application of this High Cut filter on the audio signal of the current source.

Frequency: All the frequencies below the selected one will be cut off.

GENERAL MODE

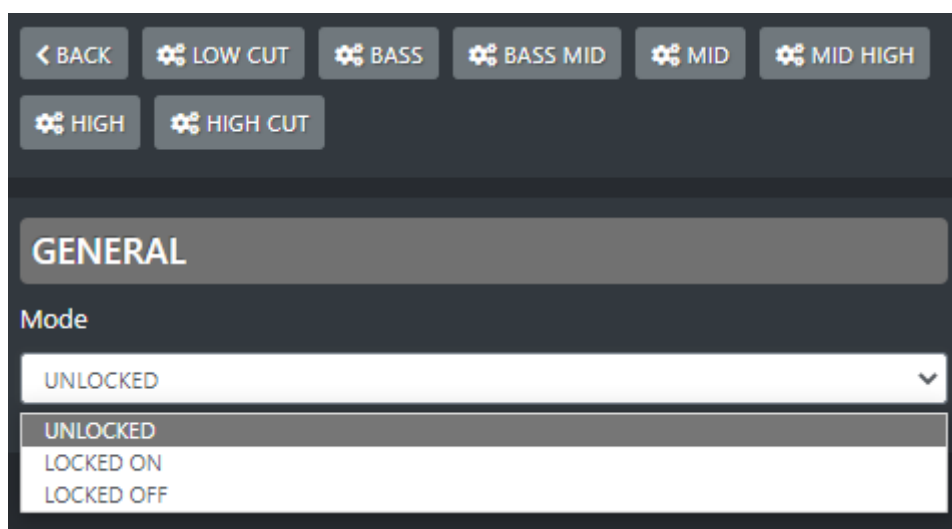

< BACK LOW CUT BASS BASS MID MID MID HIGH
HIGH HIGH CUT

GENERAL

Mode
UNLOCKED

UNLOCKED
LOCKED ON
LOCKED OFF

UNLOCKED: This mode always allows to enable/disable EQ by the presure of the related EQ button of the channel.

LOCKED ON: This mode forces the related EQ button of the channel always ON

LOCKED OFF: This mode forces the related EQ button of the channel always OFF

4.4.4.2.3 DANTE 1 / DANTE 2 / DANTE 3 / DANTE 4 / DANTE 5 / DANTE 6 / DANTE 7 / DANTE 8 (DUCKING)

The DUCKING system allows you to automatically lower the signals of the music while the speakers talk to their MICROPHONES.

For this reason, OXYGEN 1000 and OXYGEN 2000 have been designed with a very useful DUCKING function, which fulfills this need.

In the musical programs when it is mixed with a speech that needs drop music when the anchorman or the guest starts speaking. the background music instantly drops, then it pops right back up again as soon as that person finishes talking. This happens when the ducking effect in action.

Ducking temporarily lowers, or “ducks,” the volume level of a specified audio signal anytime a second specified audio signal is present. In live sound, ducking is commonly used to lower background music anytime a person speaks, then raises it when that person finishes speaking



MASTER & SLAVE is the logic on which this functionality is based.

Each console source can be defined as a MASTER source or a SLAVE source.

Usually broadcast microphones are defined as MASTER microphones and other sources in which there is music are defined as SLAVE.

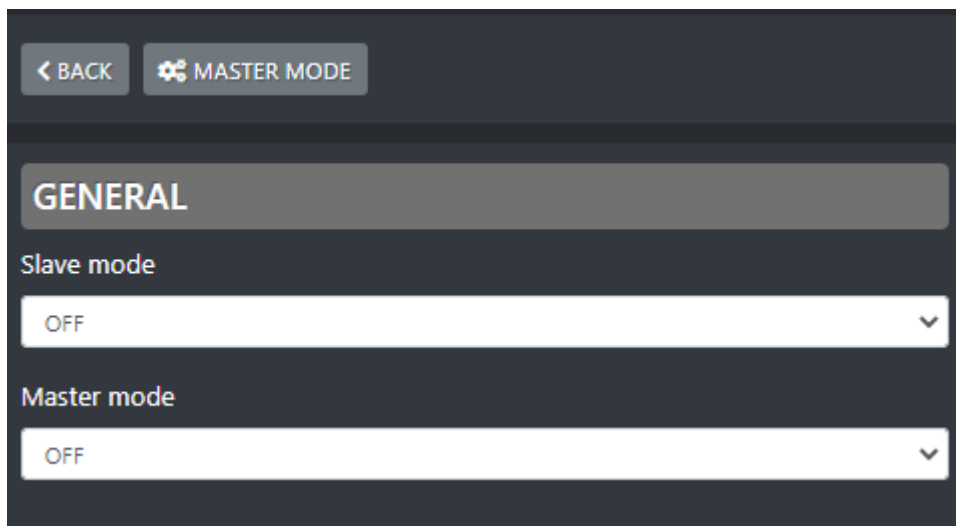
**SLAVE MODE:**

In the case of a DANTE stereo source the DUCKING MODE is suggested to be the SLAVE one. Usually it is a source with Music or Background sounds.

OFF - in this case the current source will never be lowered when any MASTER source is on air.

ON - in this case the current source will be lowered in level, whenever a MASTER source is on air.

MASTER MODE:

For some special circumstances you may need the DANTE channel set as MASTER.

OFF - in this case the current source is not selected as the MASTER source. When it is on air, the sources set as SLAVE sources will not be lowered.

ON - in this case the current source is selected as the MASTER source. When it is on air, the sources set as SLAVE sources will automatically be lowered.

4.4.5.1 TONE GEN.

The tone generator is a useful tool for testing purposes on the channels and outputs. It may be configurable and assignable to the desired channel as all the other audio sources.

4.4.5.1.1 TONE GEN. (GENERAL)

FREQUENCY



By here select the tone frequency between the available ones from a BASS tone at 30 Hz to an HIGH tone at 20 kHz.

MODE

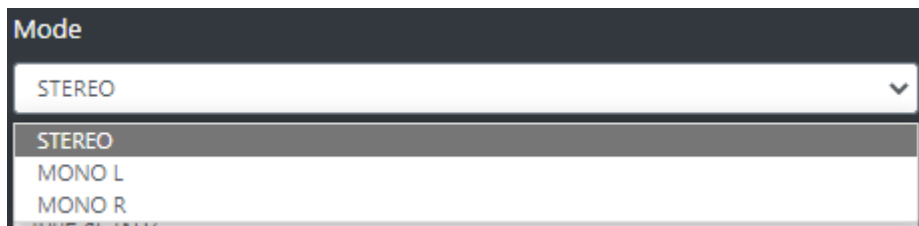

CUSTOM NAME

Type in this field a desired customized name for this Tone Generator source. This will allow the director of the program to faster identify this Tone source.



On your OXYGEN REMOTER the name of the channel will be displayed on the top of this Tone channel:

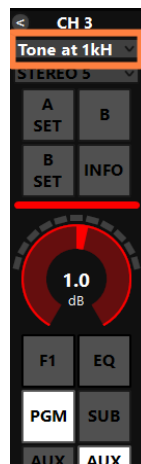

GAIN



This cursor adjusts the TONE source GAIN.

The same parameter could be modified directly from the related OXYGEN REMOTER channel:

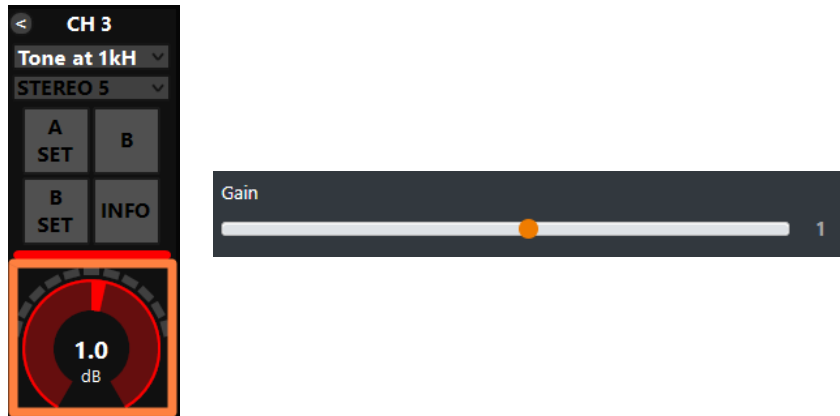

The parameter has a 0.1 dB step for a minimum of -20.0 dB to a maximum of 20.0 dB. Default value is 0.0 dB

AUX-1

This submenu could be used to specify the behaviour of the current audio source in relation with the logical output AUX-1.



PRE FADER: The fader movement of the channel does not affect the AUX-1 logical output signal.

POST FADER: The fader movement of the channel affects the AUX-1 logical output signal.

PRE FADER ALWAYS ON: The fader movement of the channel does not affect the AUX-1 logical output signal and the source is always forwarded to the AUX-1 logical output, bypassing the ON button of the channel

AUX-2

This submenu could be used to specify the behaviour of the current audio source in relation with the logical output AUX-1.

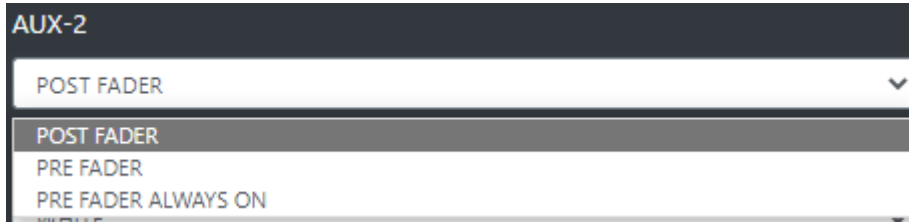

PRE FADER: The fader movement of the channel does not affect the AUX-2 logical output signal.

POST FADER: The fader movement of the channel affects the AUX-2 logical output signal.

PRE FADER ALWAYS ON: The fader movement of the channel does not affect the AUX-2 logical output signal and the source is always forwarded to the AUX-2 logical output, bypassing the ON button of the channel

BUTTON LIGHT



Between available colors, select the one to be assigned to the following channel buttons:

F1, EQ, PGM, SUB, AUX1, AUX2

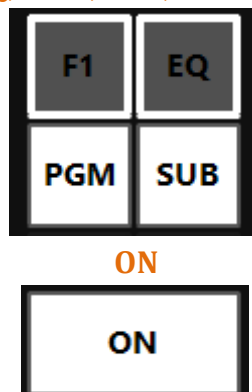

The selection affects all the channels to which this audio source is assigned.

To modify the customizable COLOR 1, COLOR 2, COLOR 3, COLOR 4, go in the menu:

SETUP / GENERAL / LIGHT&DISPLAY

FADER BAR LIGHT

Between available colors, select the one to be assigned to the following channel controls:

ON led, GAIN adjustment



FADER BAR, FADER SLIDER

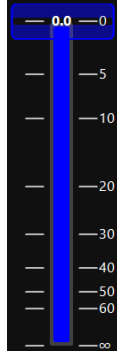

ON MODULE



BY BUTTON & FADER: The airing of the channel needs an interaction of the ON button and a slide up of the fader.

The channel to be considered ON has to be into the following status:

ON = active

SLIDER = higher than $-\infty$

BY FADER: The airing of the channel needs only a slide up of the fader. The OFF status of the channel could only be reached by sliding down the fader and not by ON button pressure.

The channel to be considered ON has to be into the following status:

SLIDER = higher than $-\infty$

BY BUTTON: The airing of the channel needs only an interaction with the ON button:

The channel to be considered ON has to be into the following status:

ON = active

The slider movements will not affect the ON/OFF status of the channel.

ALWAYS ON: The channel is always considered ON. The sliding down of the fader never put the channel in OFF status.

ALWAYS OFF: The channel is always considered OFF.

4.4.5.1.2 TONE GEN. (EQ)

NOT AVAILABLE

4.4.5.1.3 TONE GEN. (DUCKING)

NOT AVAILABLE

4.5.1 OUTPUTS

From this OXYGEN REMOTER subsection you can remotely manage all the console audio outputs. All the available outputs are divided and grouped in the following general categories:

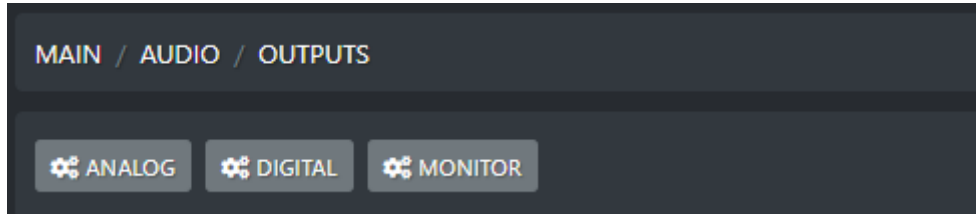

4.5.1.1 ANALOG

OUT-1 is the one labelled as ANALOG-OUT-1 on L-R XLR male connectors

OUT-2 is the one labelled as ANALOG-OUT-2 on L-R XLR male connectors

OUT-3 is the one labelled as ANALOG-OUT 3 on RJ45 female connector

OUT-4 is the one labelled as ANALOG-OUT 4 on RJ45 female connector

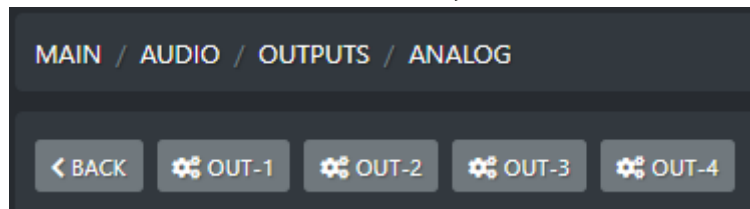

4.5.1.1.1 OUT-1 (PROGRAM)

The source of OUT-1 is not selectable by the user. By default is the one forwarded by PGM logical BUS.

MODE

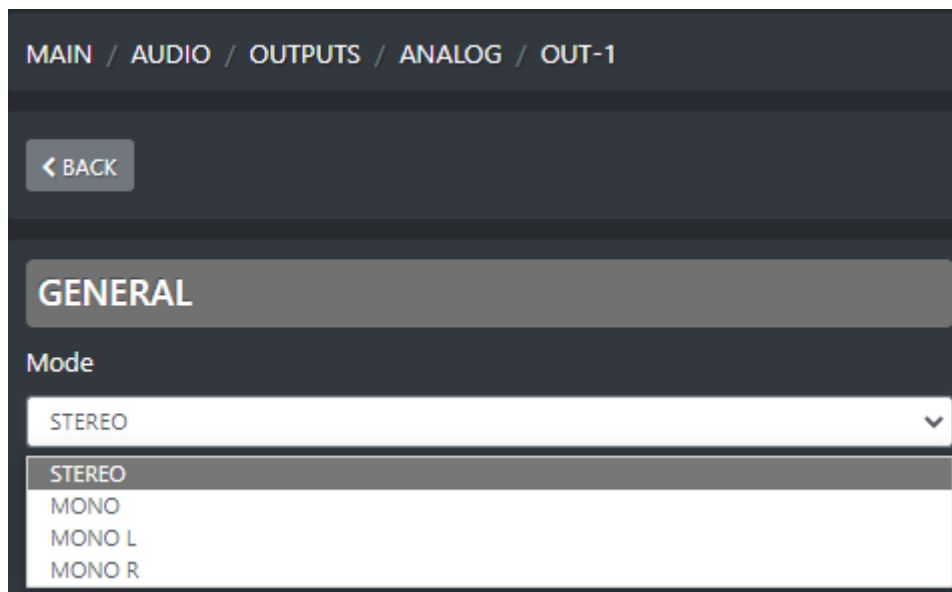

Below an explication of all the OUT-1 stereo modes:

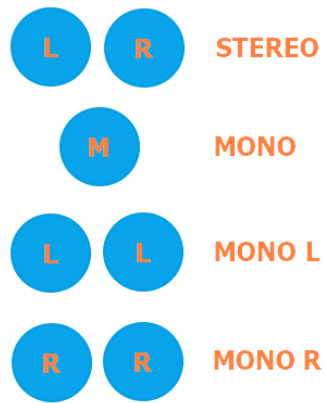

GAIN



This cursor adjusts the OUT-1 output GAIN.
The parameter has a 0.1 dB step for a minimum of -6.0 dB to a maximum of 6.0 dB.
Default value is 0.0 dB.

4.5.1.1.2 OUT-2

By default SPK-CR

SOURCE

The source of OUT-2 is selectable by the user. By default is the one charged to transport the SPK-CR monitoring signal. It is possible to change this default setting by choosing a different logical BUS between PGM/SUB/AUX-1/AUX-2 or by selecting one of the monitoring signals SPK-CR/HDP-CR/SPK-STD/HDP-STD, or by using it as a cleanfield /n-1 channel for the additional TELCO devices T2 and T3. The TONE GEN. has only test purposes for the audio output.

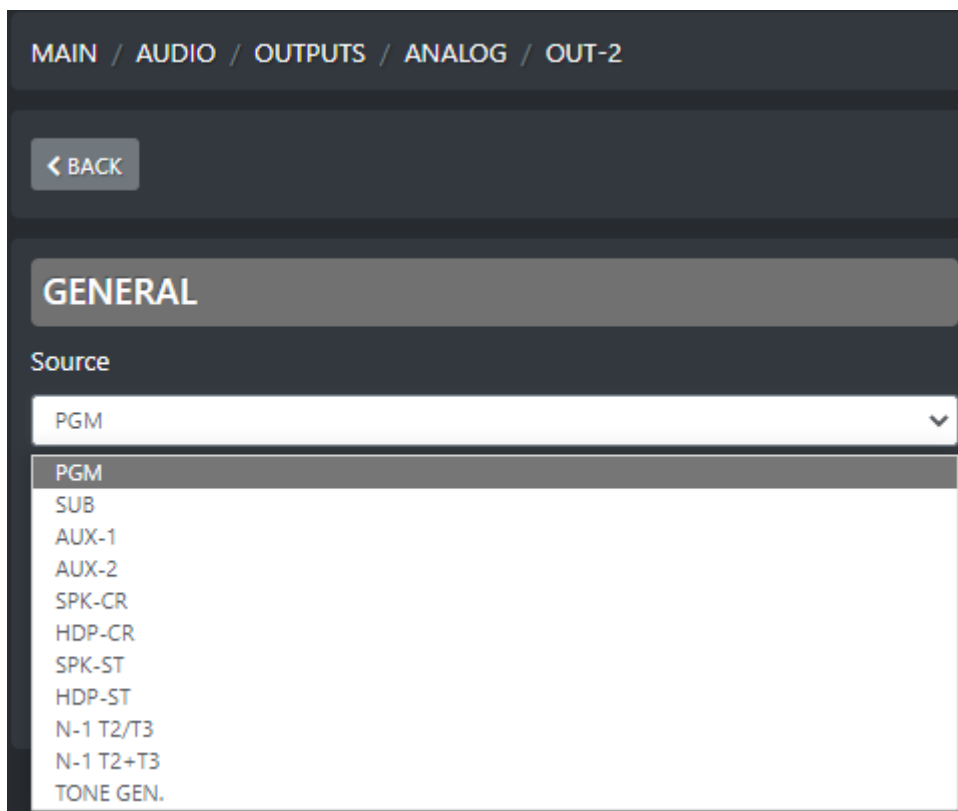

MODE



Below an explication of the only OUT-2 mode:



GAIN



This cursor adjusts the OUT-2 output GAIN.
The parameter has a 0.1 dB step for a minimum of -6.0 dB to a maximum of 6.0 dB.
Default value is 0.0 dB.

4.5.1.1.3 OUT-3

By default SPK-STD

SOURCE

The source of OUT-3 is selectable by the user. By default is the one charged to transport the SPK-STD monitoring signal. It is possible to change this default setting by choosing a different logical BUS between PGM/SUB/AUX-1/AUX-2 or by selecting one of the monitoring signals SPK-CR/HDP-CR/SPK-STD/HDP-STD, or by using it as a cleanfield/n-1 channel for the additional TELCO devices T2 and T3. The TONE GEN. has only test purposes for the audio output.

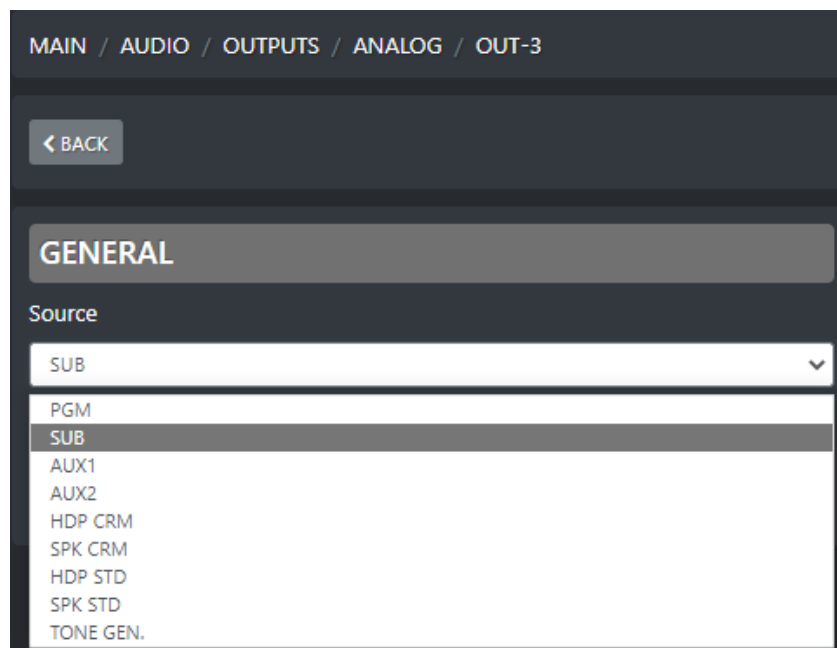

MODE



Below an explication of the only OUT-3 mode:



4.5.1.1.4 OUT-4

SOURCE

The source of OUT-4 is selectable by the user between the available logical BUSS PGM/SUB/AUX-1/AUX-2 or by selecting one of the monitoring signals SPK-CR/HDP-CR/SPK-STD/HDP-STD. The TONE GEN. has only test purposes for the audio output.

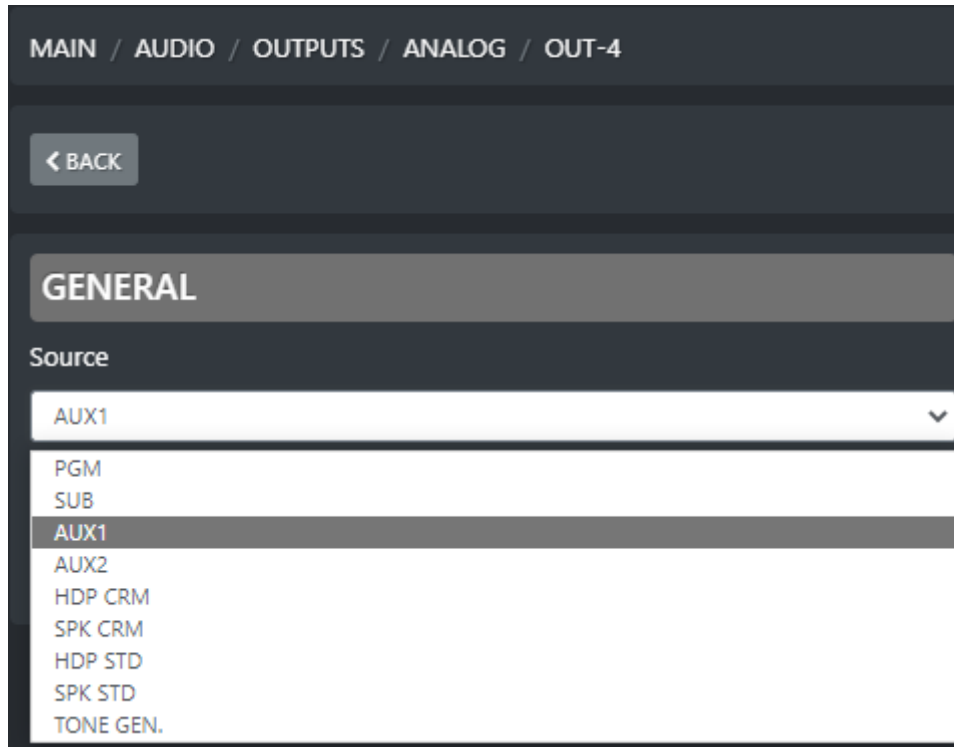

MODE



4.5.1.2 DIGITAL

The MAIN / AUDIO / OUTPUTS / DIGITAL menu could be in one of the two different modes:

CONSOLE WITHOUT DANTE OPTION

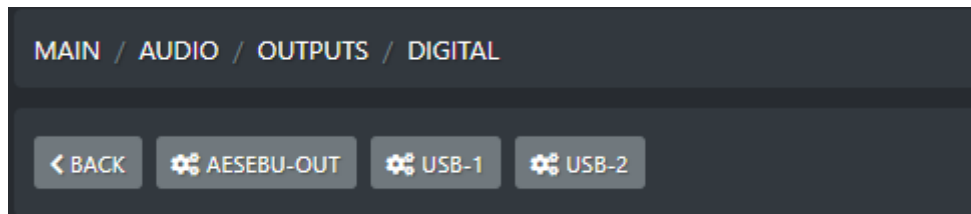

Purchasing an OXYGEN 1000 or OXYGEN 2000 without DANTE option you will have available the AESEBU-OUT and the 2 USB outputs (USB-1 and USB-2) instead of the DANTE ones.

CONSOLE WITH DANTE OPTION

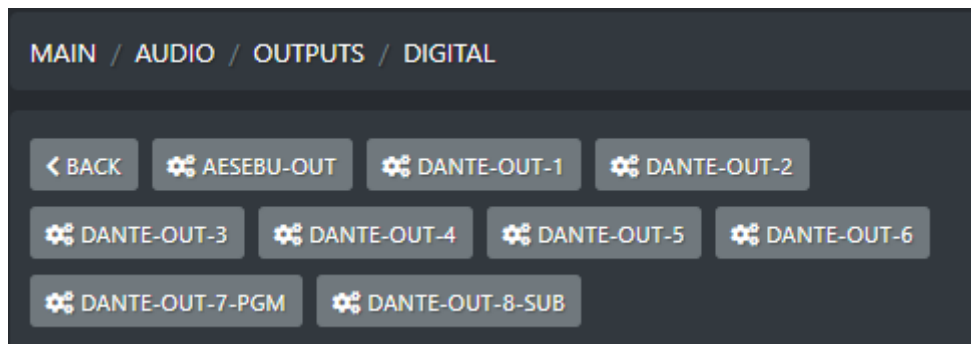

Purchasing an OXYGEN 1000 or OXYGEN 2000 with the DANTE option you will have available the AESEBU-OUT and the 8 DANTE-OUT outputs. In this case the USB outputs will not be available.

Into the **DANTE-OUT-7-PGM** is automatically routed the audio signal of the PGM logical BUS.
Into the **DANTE-OUT-8-SUB** is automatically routed the audio signal of the SUB logical BUS.

4.5.1.2.1 AESEBU-OUT (ON THE “DIGITAL OUT” CONNECTOR)

SOURCE

The source of AESEBU-OUT is selectable by the user by choosing a logical BUS between PGM/SUB/AUX-1/AUX-2 or by selecting one of the monitoring signals SPK-CR/HDP-CR/SPK-STD/HDP-STD. The TONE GEN. has only test purposes for the audio output.

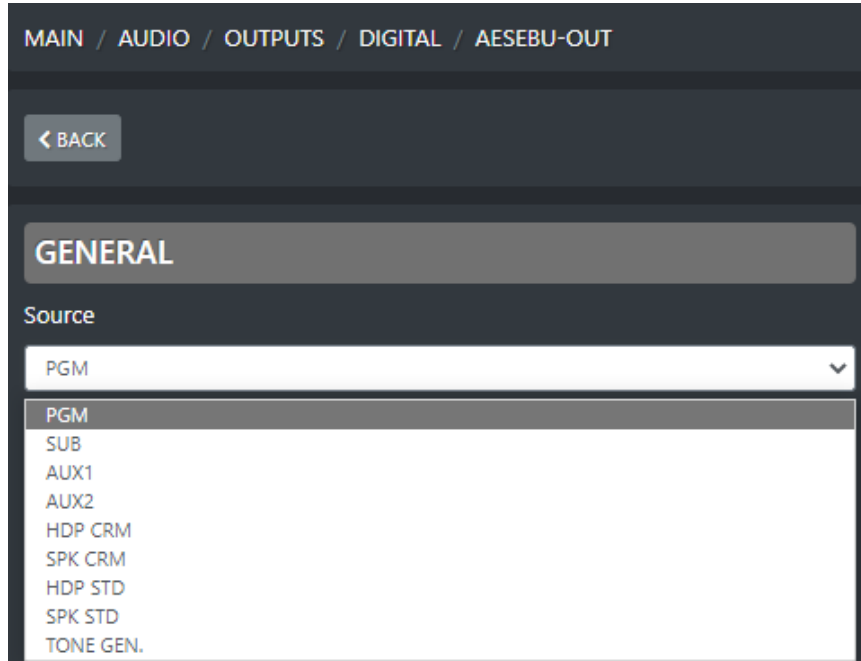

MODE

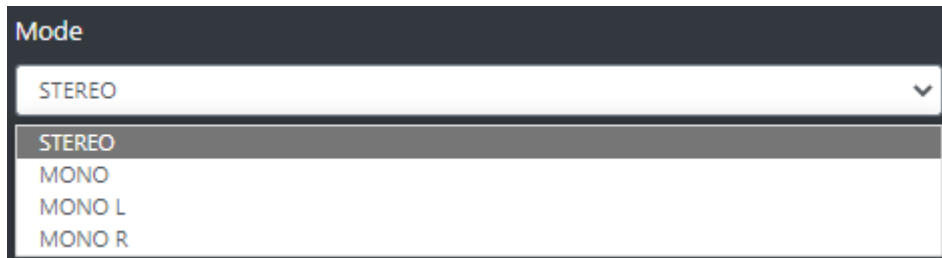

Below an explication of all the AESEBU-OUT stereo modes:

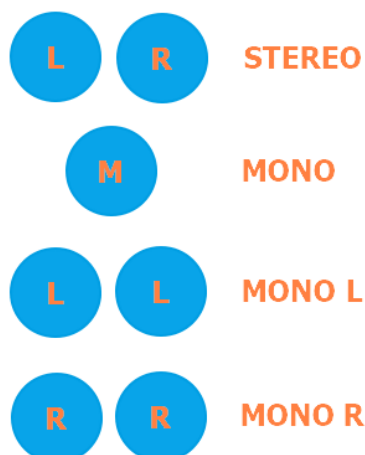

GAIN



This cursor adjusts the AESEBU-OUT output GAIN.
 The parameter has a 0.1 dB step for a minimum of -24.0 dB to a maximum of -12.0 dB.
 Default value is -18.0 dB.

4.5.1.2.2 USB 1 / USB 2

SOURCE

The source of AESEBU-OUT is selectable by the user by choosing a logical BUS between PGM/SUB/AUX-1/AUX-2 or by selecting one of the monitoring signals SPK-CR/HDP-CR/SPK-STD/HDP-STD. The TONE GEN. has only test purposes for the audio output.

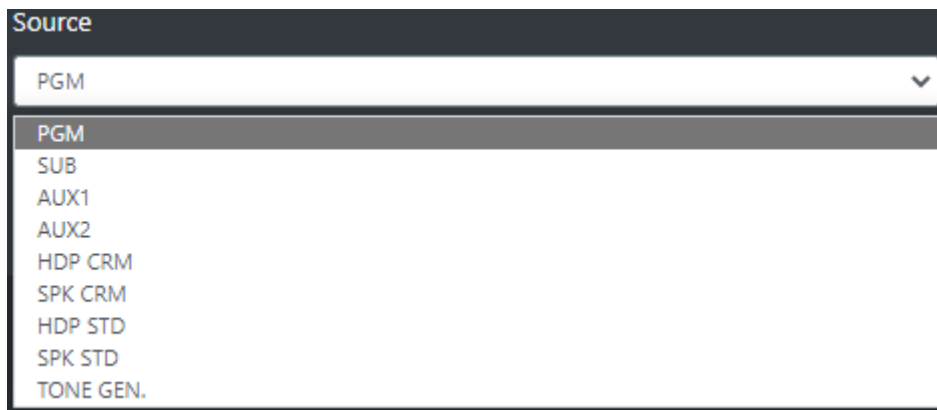

GAIN



This cursor adjusts the related USB-1 or USB-2 output GAIN.
 The parameter has a 0.1 dB step for a minimum of -24.0 dB to a maximum of -12.0 dB.
 Default value is -18.0 dB.

4.5.1.2.3 DANTE-OUT-1 / DANTE-OUT-2 / DANTE-OUT-3 / DANTE-OUT-4 / DANTE-OUT-5 / DANTE-OUT-6 / DANTE-OUT-7-PGM / DANTE-OUT-8-SUB /

SOURCE (DANTE-OUT-1 / DANTE-OUT-2 / DANTE-OUT-3 / DANTE-OUT-4 / DANTE-OUT-5 / DANTE-OUT-6)

The source of these DANTE outputs is selectable by the user by choosing a different logical BUS between PGM/SUB/AUX-1/AUX-2 or by selecting one of the monitoring signals SPK-CR/HDP-CR/SPK-STD/HDP-STD, or by using it as a cleanfield/n-1 channel for the additional TELCO devices T4 and T5. The TONE GEN. has only test purposes for the audio output.

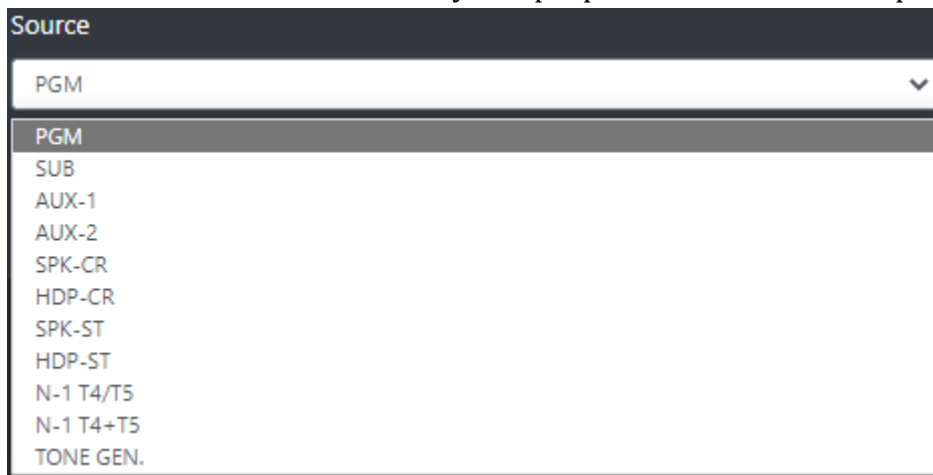

MODE (DANTE-OUT-5 / DANTE-OUT-6 / DANTE-OUT-7-PGM / DANTE-OUT-8-SUB)

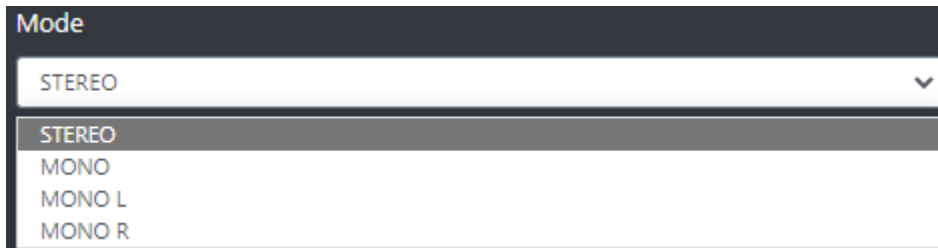

Below an explication of all of the output modes of these DANTE output channels:

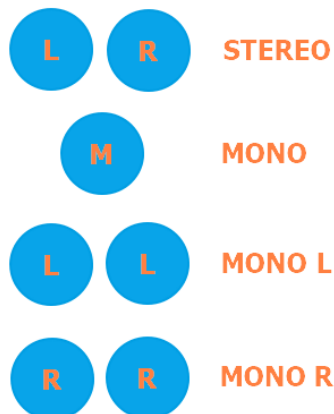

GAIN



This cursor adjusts the output GAIN of the current DANTE output. The parameter has a 0.1 dB step for a minimum of -6.0 dB to a maximum of +6.0 dB. Default value is 0.0 dB.

4.5.1.3 MONITOR

Into this section you can manage all the settings related with your audio output monitors: speakers and headphones. The settings of each of them is a bit differentiate. The first between them is related with the microphones CUT modem that works with speakers (to avoid larsen and feedback) but it's completely useless with the headphones.

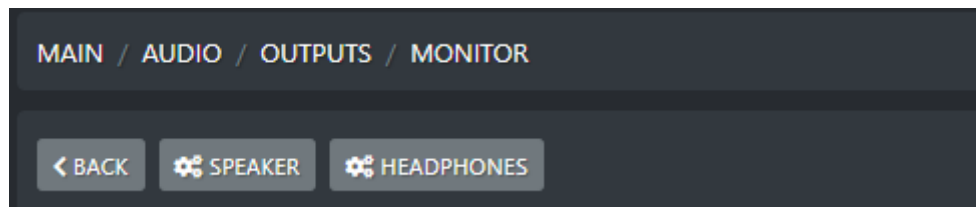

A. SPEAKER

Into the SPEAKER section you have a differentiation between the directing control room SPK-CRM, useful for the director monitoring and the SPK-STUDIO for the anchorman and guests or.

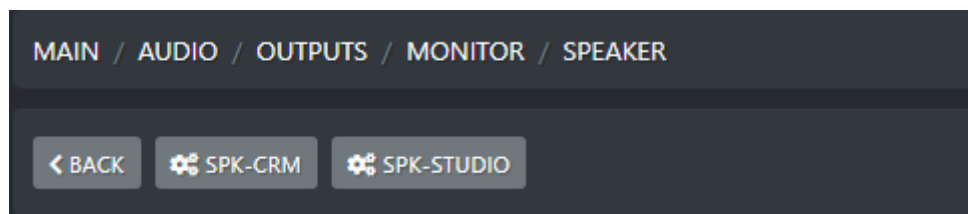

I. SPK-CRM

This section is the proper area for the management of the speakers usually next to the console, in the control room. These speakers make the program director to listen the selected source or they make the program director to be involved in technical offair communications (talkback).

MODE



2SEL+PFL: Control Room Headphones and speakers will be independent.

You will be able to select what logic audio BUS you want to monitoring on the Headphones and a different and desired logic audio BUS on the Speakers. In this case PFL will have the highest priority and if it is active at least on a channel, you will stop to listen the selected BUS and you will start to listen the pressed PFL from SPK-CRM.

By the following example you can see in this situation you have enabled the SPK-CRM source selection currently set on PGM:



By the following example you can see in this situation you have enabled the HDP-CRM source selection currently set on SUB:

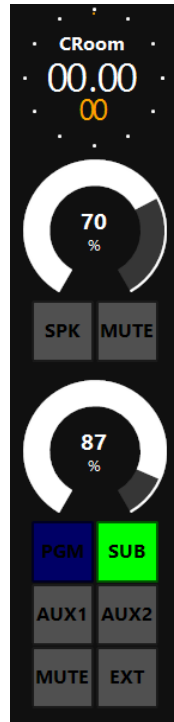

2SEL: Control Room Headphones and speakers will be independent. You will be able to select what logic audio BUS you want to monitoring on the Headphones and a different and desired logic audio BUS on the Speakers. The PFL pressure on the channel will be ignored.

By the following example you can see in this situation you have enabled the SPK-CRM source selection currently set on PGM:

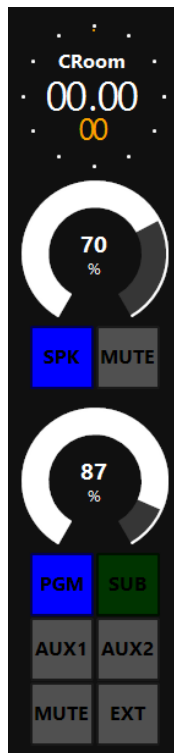

By the following example you can see in this situation you have enabled the HDP-CRM source selection currently set on SUB. The PFL pressure on the channel will be ignored:

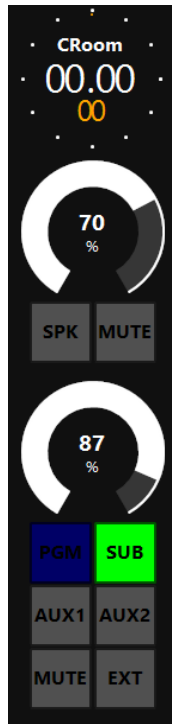

1SEL+PFL: Control Room Headphones and speakers will listen the same selected source. In this case PFL will have the highest priority and if it is active at least on a channel, you will stop to listen the selected BUS and you will start to listen the pressed PFL from SPK-CRM.

By the following example you can see in this situation you have the same source selection for both SPK-CRM and HDP-CRM currently set on AUX1:

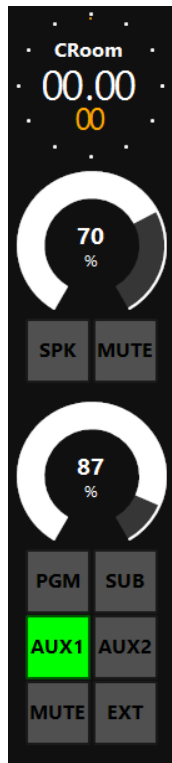

1SEL: Control Room Headphones and speakers will listen the same selected logic audio BUS. The PFL pressure on the channel will be ignored.

By the following example you can see in this situation you have the same source selection for both SPK-CRM and HDP-CRM currently set on AUX1. The PFL pressure on the channel will be ignored:

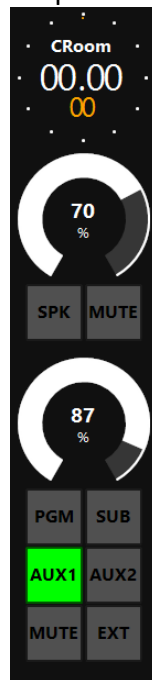

TALKBACK

This TALKBACK parameter rules the behaviour of your Control Room Speakers in the technical and internal offair communications.

1. In example this communication could be useful to make the ONAIR countdown before the start of a Radio Program: in this case the message comes from the director/control room towards the studio anchorman/guests.
2. In example this communication could be useful to the guests to ask a glass of water, avoiding to be aired during this technical request: in this case the message comes from the studio anchorman/guests towards the director/control room.

This last example n. 2 could be activated or deactivated by the following parameter only in relation with SPK-CRM (Control Room Speakers).

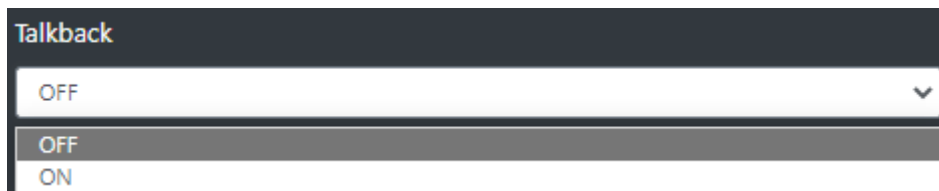

OFF: The messages (of the example n. 2) coming from studio anchorman and guests won't be listened by SPK-CRM.

ON: The messages (of the example n. 2) coming from studio anchorman and guests will be listened by SPK-CRM

MAX LEV OUT

It is possible to limit the maximum audio level of the current SPK-CRM output in the case of current loudness is too high for the needs.

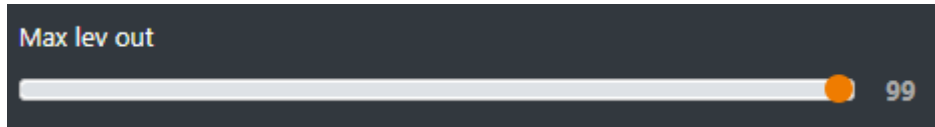

By adjusting this cursor you will be able to reduce the allowed MAX LEV OUT. The parameter has a 1 % step for a minimum of 0 % to a maximum of 99 %. Default value is 99 %.

CUT ATT MODE

On each Microphone Setting Panel you can decide if it CUTs with SPK-CRM or with SPK-STUDIO. Usually, if the Microphone is in the Control Room it has to CUT with the Control Room Speakers, if it is in the Studio it has to CUT with the Studio Speakers.

The following parameter rules the behaviour of the Control Room Speakers with all of its cutting microphones.

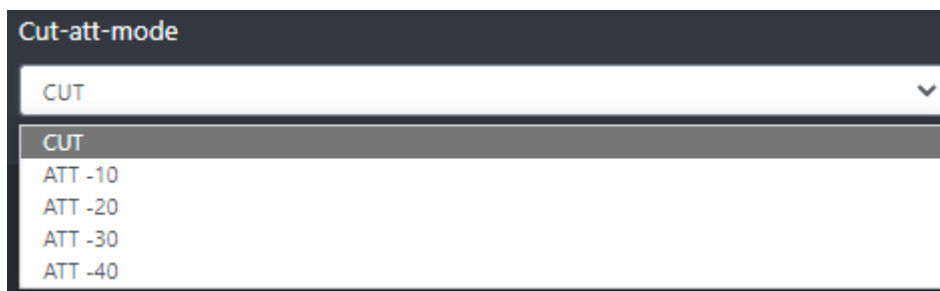

CUT: The audio signal of the cutting microphone, when it is aired and active, will be drastically CUT.

ATT -10: The audio signal of the cutting microphone, when it is aired and active, will be reduced of 10 dB.

ATT -20: The audio signal of the cutting microphone, when it is aired and active, will be reduced of 20 dB.

ATT -30: The audio signal of the cutting microphone, when it is aired and active, will be reduced of 30 dB.

ATT -40: The audio signal of the cutting microphone, when it is aired and active, will be reduced of 40 dB.

II. SPK-STUDIO

This section is the proper area for the management of the speakers usually in the studio side. These speakers make the anchorman and studio guests listen the selected source or they make the anchorman and studio guests to be involved in technical offair communications (talkback).

MODE



2SEL+PFL: Studio Headphones and speakers will be independent.

You will be able to select what logic audio BUS you want to monitoring on the Headphones and a different and desired logic audio BUS on the Speakers. In this case PFL will have the highest priority and if it is active at least on a channel, you will stop to listen the selected BUS and you will start to listen the pressed PFL from SPK-STUDIO.

By the following example you can see in this situation you have enabled the SPK-STUDIO source selection currently set on PGM:

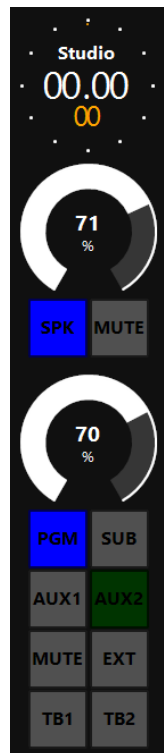

By the following example you can see in this situation you have enabled the HDP-STUDIO source selection currently set on AUX2:

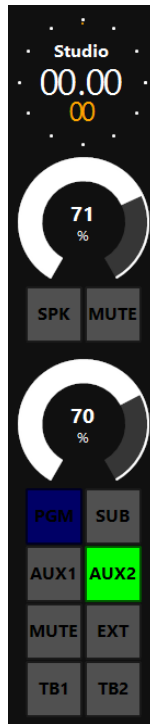

2SEL: Control Room Headphones and speakers will be independent. You will be able to select what logic audio BUS you want to monitoring on the Headphones and a different and desired logic audio BUS on the Speakers. The PFL pressure on the channel will be ignored.

By the following example you can see in this situation you have enabled the SPK-STUDIO source selection currently set on PGM:

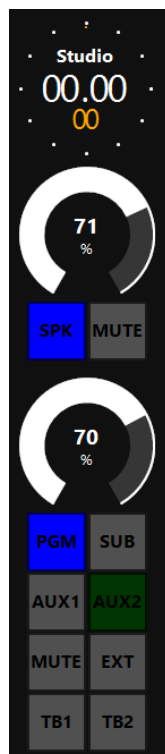

By the following example you can see in this situation you have enabled the HDP-STUDIO source selection currently set on AUX2. The PFL pressure on the channel will be ignored:

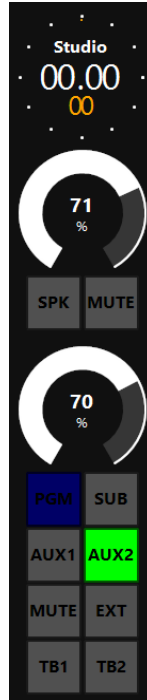

1SEL+PFL: Control Room Headphones and speakers will listen the same selected source. In this case PFL will have the highest priority and if it is active at least on a channel, you will stop to listen the selected BUS and you will start to listen the pressed PFL from SPK-CRM.

By the following example you can see in this situation you have the same source selection for both SPK-STUDIO and HDP-STUDIO currently set on SUB:

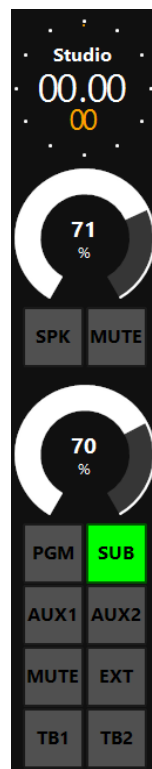

1SEL: Control Room Headphones and speakers will listen the same selected logic audio BUS. The PFL pressure on the channel will be ignored.

By the following example you can see in this situation you have the same source selection for both SPK-STUDIO and HDP-STUDIO currently set on SUB. The PFL pressure on the channel will be ignored:

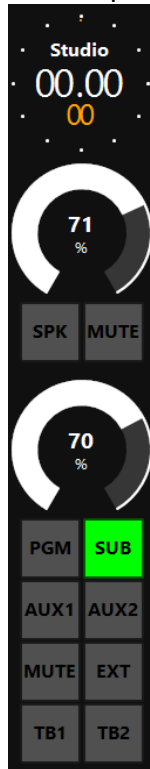

PGM: SPK-STUDIO is forced on the PGM monitoring

SUB: SPK-STUDIO is forced on the SUB monitoring

AUX1: SPK-STUDIO is forced on the AUX1 monitoring

AUX2: SPK-STUDIO is forced on the AUX2 monitoring

EXT: SPK-STUDIO is forced on the EXT monitoring

To change the EXT source to be monitored please go in **MAIN / AUDIO /SETTING**

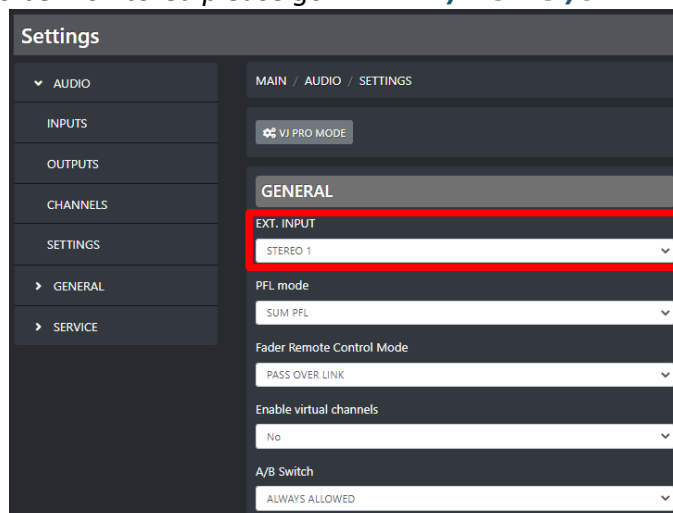

TALKBACK

This TALKBACK parameter rules the behaviour of your Studio Speakers in the technical and internal offair communications.

1. In example this communication could be useful to make the ONAIR countdown before the start of a Radio Program: in this case the message comes from the director/control room towards the studio anchorman/guests.-
2. In example this communication could be useful to the guests to ask a glass of water, avoiding to be aired during this technical request: in this case the message comes from the studio anchorman/guests towards the director/control room.

The first example n. 1 could be totally deactivated for SPK-STUDIO or it is possible to select if the listened audio talkback is the one directed to TB1, to TB2 or to both TB1+TB2 by the following parameter:

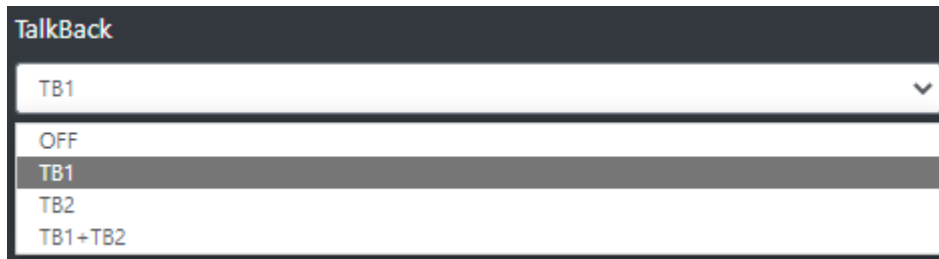

OFF: The messages (of the example n. 1) coming from director / control room by the pressure of TB1 or TB2 towards anchorman / guests won't be listened by SPK-STUDIO.

TB1: Only the messages (of the example n.1) coming from director / control room by the pressure of TB1 towards anchorman / guests will be listened by SPK-STUDIO.

TB2: Only the messages (of the example n.1) coming from director / control room by the pressure of TB2 towards anchorman / guests will be listened by SPK-STUDIO.

TB1+TB2: The messages (of the example n.1) coming from director / control room by the pressure of TB1 or TB2 towards anchorman / guests will be both listened by SPK-STUDIO.

MAX LEV OUT

It is possible to limit the maximum audio level of the current SPK-STUDIO output in the case of current loudness is too high for the needs.



By adjusting this cursor you will be able to reduce the allowed MAX LEV OUT.

The parameter has a 1 % step for a minimum of 0 % to a maximum of 99 %.

Default value is 99 %.

CUT ATT MODE

On each Microphone Setting Panel you can decide if it CUTs with SPK-CRM or with SPK-STUDIO. Usually, if the Microphone is in the Control Room it has to CUT with the Control Room Speakers, if it is in the Studio it has to CUT with the Studio Speakers.

The following parameter rules the behaviour of the Studio Speakers with all of its cutting microphones.

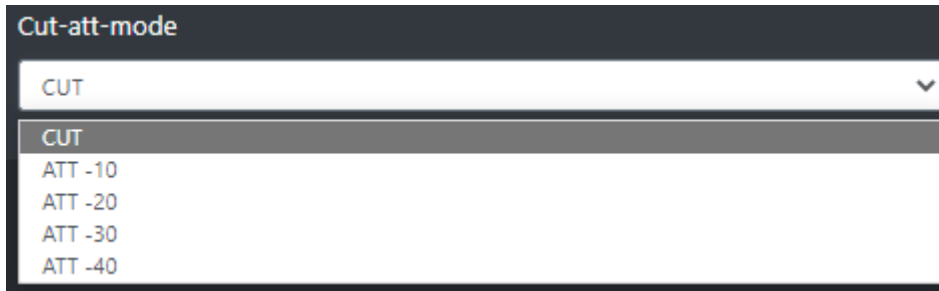

CUT: The audio signal of the cutting microphone, when it is aired and active, will be drastically CUT.

ATT -10: The audio signal of the cutting microphone, when it is aired and active, will be reduced of 10 dB.

ATT -20: The audio signal of the cutting microphone, when it is aired and active, will be reduced of 20 dB.

ATT -30: The audio signal of the cutting microphone, when it is aired and active, will be reduced of 30 dB.

ATT -40: The audio signal of the cutting microphone, when it is aired and active, will be reduced of 40 dB.

B. HEADPHONES

Into the HEADPHONES section you have a differentiation between the directing control room HDP-CRM, useful for the director monitoring and the HDP-STUDIO for the anchorman and guests.

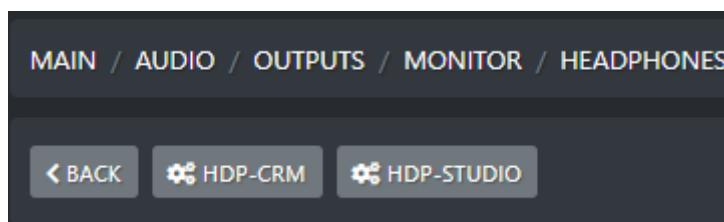

I. HDP-CRM

This section is the proper area for the management of the Headphones usually in the directing control room side. These headphones make the director / control room listen the selected source or make these headphones to be involved in technical offair communications (talkback).

MODE



SEL: In this case of audio monitoring through Control Room Headphones, the PFL pressure on the channel will be ignored. It will only be listened the selected BUS.

SEL+PFL: In this case of audio monitoring through Control Room Headphones, the activation of the PFL will have the highest priority and if it is active at least on a channel, you will stop to listen the selected BUS and you will start to listen in HDP-CRM the pressed PFL.

TALKBACK



ON: by these Control Room Headphones you will be able to listen all the talkback microphones set as Studio ones (in the direction by the STUDIO towards to the CONTROL ROOM)

OFF: these Control Room Headphones will not be involved in technical offair communications (talkback)

MAX LEV OUT

It is possible to limit the maximum audio level of the current HDP-CRM output in the case of current loudness is too high for the needs.



By adjusting this cursor you will be able to reduce the allowed MAX LEV OUT. The parameter has a 1 % step for a minimum of 0 % to a maximum of 99 %. Default value is 99 %.

II. HDP-STUDIO

This section is the proper area for the management of the Headphones usually in the studio side. These headphones make the anchorman and the studio guests listen the selected source or make these headphones to be involved in technical offair communications (talkback).

LINK MODE



NOT LINKED: the selection of the audio source to be listened with Studio Headphones will be not linked with the selection of the audio source listened with Control Room Headphones.

LINKED TO CRM: the selection of the audio source to be listened with Studio Headphones will be slaved and linked with the selection of the master audio source listened with Control Room Headphones.

MODE



SEL+PFL: In this case PFL will have the highest priority and if it is active at least on a channel, you will stop to listen the selected BUS and you will start to listen the pressed PFL from HDP-STUDIO.

SEL: The PFL pressure on the channel will be ignored, HDP-STUDIO will only listen for the selected BUS

PGM: HDP-STUDIO is forced on the PGM monitoring

SUB: HDP-STUDIO is forced on the SUB monitoring

AUX1: HDP-STUDIO is forced on the AUX1 monitoring

AUX2: HDP-STUDIO is forced on the AUX2 monitoring

EXT: HDP-STUDIO is forced on the EXT monitoring

TALKBACK

This TALKBACK parameter rules the behaviour of your Studio Headphones in the technical and internal offair communications.

1. In example this communication could be useful to make the ONAIR countdown before the start of a Radio Program: in this case the message comes from the director/control room towards the studio anchorman/guests.-
2. In example this communication could be useful to the guests to ask a glass of water, avoiding to be aired during this technical request: in this case the message comes from the studio anchorman/guests towards the director/control room.

The first example n. 1 could be totally deactivated for HDP-STUDIO or it is possible to select if the listened audio talkback is the one directed to TB1, to TB2 or to both TB1+TB2 by the following parameter:



OFF: The messages (of the example n. 1) coming from director / control room by the pressure of TB1 or TB2 towards anchorman / guests won't be listened by HDP-STUDIO.

TB1: Only the messages (of the example n.1) coming from director / control room by the pressure of TB1 towards anchorman / guests will be listened by HDP-STUDIO.

TB2: Only the messages (of the example n.1) coming from director / control room by the pressure of TB2 towards anchorman / guests will be listened by HDP-STUDIO.

TB1+TB2: The messages (of the example n.1) coming from director / control room by the pressure of TB1 or TB2 towards anchorman / guests will be both listened by HDP-STUDIO.

MAX LEV OUT

It is possible to limit the maximum audio level of the current HDP-STUDIO output in the case of current loudness is too high for the needs.



By adjusting this cursor you will be able to reduce the allowed MAX LEV OUT.

The parameter has a 1 % step for a minimum of 0 % to a maximum of 99 %.

Default value is 99 %.

4.6.1 CHANNELS

OXYGEN 1000

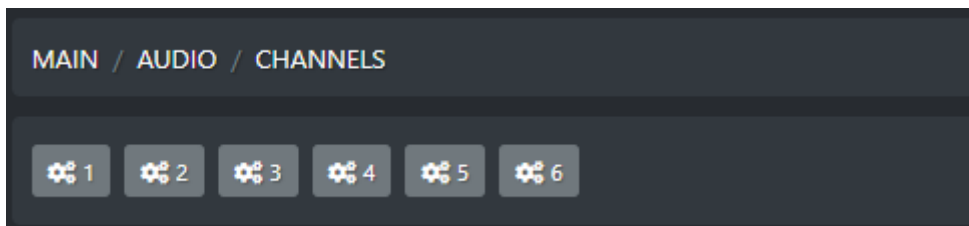

OXYGEN 2000

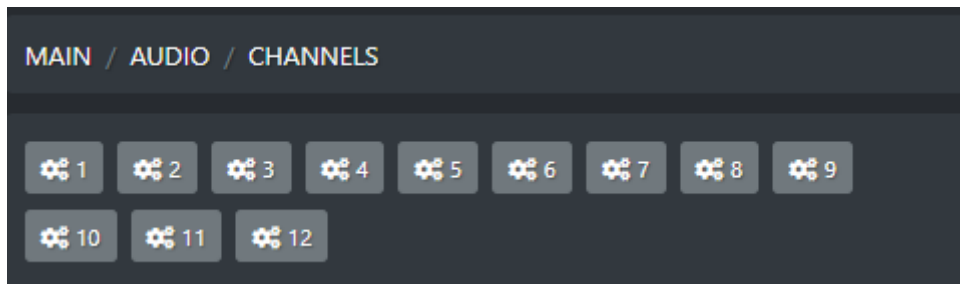

Inside each channel you can set the related 2 SOURCE A and SOURCE B:

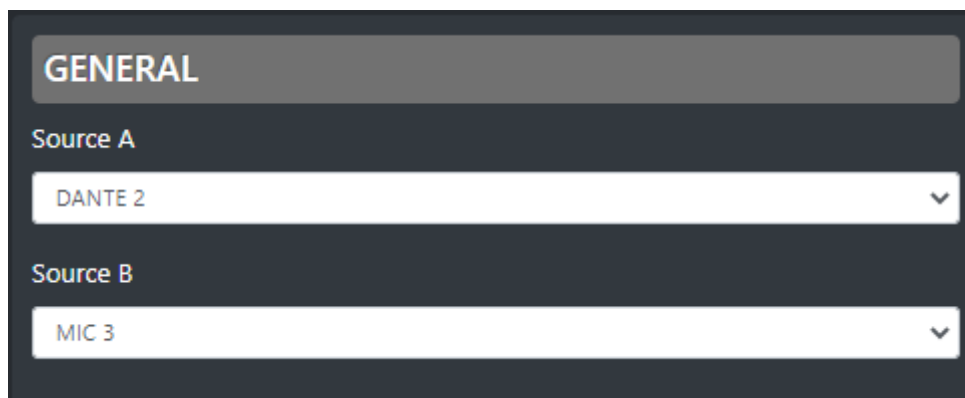

The same ones you can set from the following top section of each channel:



In this example to activate the SOURCE B, activate the button:



4.7.1 SETTINGS

4.7.1.1 GENERAL / INPUT MODE

A. EXT. INPUT

It happens that you want to quickly monitor a specific audio, for example there are those who always want to be able to monitor their own FM / WEB / DAB audio signal.

EXT. INPUT has exactly this functionality, you can assign one of the sources that you see below.

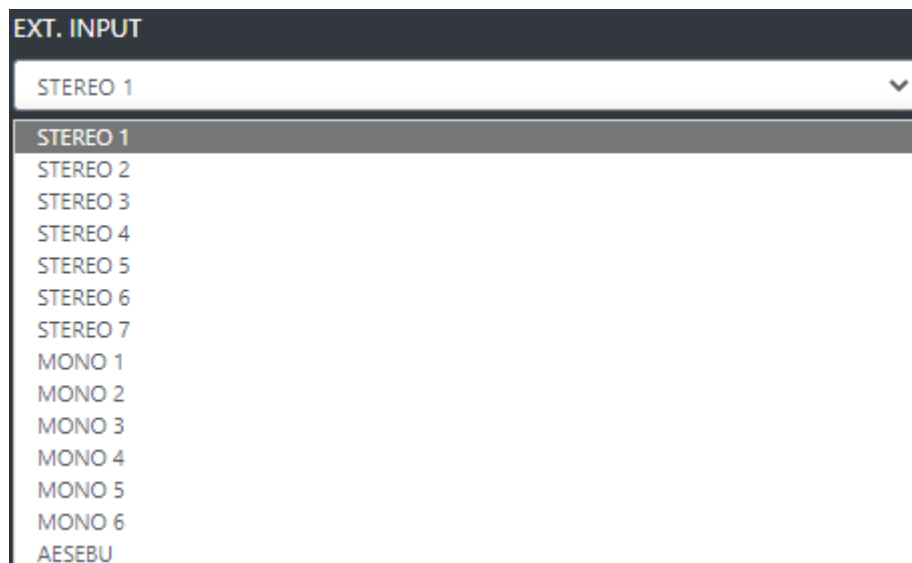

From the audio speakers and monitor headphones it will always be possible to access the listening of EXT. INPUT by pressing the following buttons:

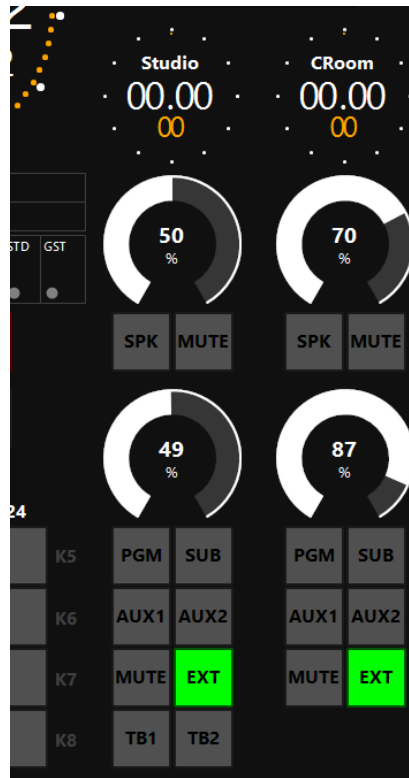

B. PFL MODE

The use of the PFL can take place in 2 different ways:



SINGLE PFL:

In this mode, the activation of a channel PFL will automatically disable the PFL that was previously pre-listened. They will therefore work one at a time.

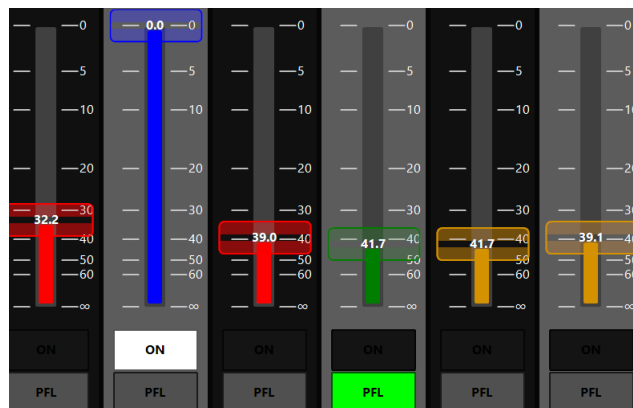

SUM PFL:

In this mode, the activation of a channel PFL will be automatically added to the previously pre-listened PFL. More than one can therefore be used simultaneously.

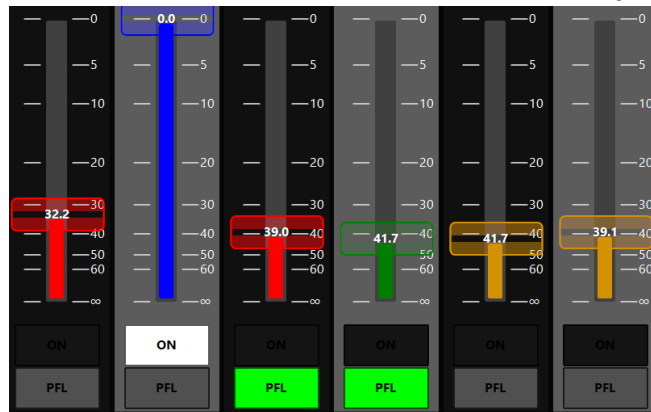

C. FADER REMOTE CONTROL MODE

This parameter allows you to manage the relationship of all channels between the relative physical slider and the corresponding virtual slider:



DIRECT LINK: this setting always maintains the coordination between the movement of the physical slider and the movement of the related virtual slider within the OXYGEN REMOTER. The physical slider always drags the virtual slider with itself.

PASS OVER LINK: this setting takes effect everytime the virtual slider is raised/lowered by OXYGEN REMOTER.

The related physical slider is disconnected and even if moved it does not drag the virtual slider of OXYGEN REMOTER with itself.

In order for the physical slider to have control over the virtual slider again, you should put the physical slider level into the following condition:

$$Physical\ Slider\ Level = Virtual\ Slider\ Level$$

D. ENABLE VIRTUAL CHANNELS

Oxygen consoles have the peculiarity of being able to use, at the complete discretion of the user, up to 8 additional Virtual Channels compared to the 6 (OXYGEN 1000) and 12 (OXYGEN 2000) standard Physical Channels.



No: The displayed OXYGEN REMOTER channels will only be the 6 (OXYGEN 1000) and 12 (OXYGEN 2000) standard Physical Channels.

Yes: By selecting this Yes option, the user enables the possibility to add up to 8 VIRTUAL CHANNELS. To learn more about this function, please consult the related ADDITIONAL VIRTUAL CHANNELS chapter of this User Manual.

E. A/B SWITCH



ALWAYS ALLOWED: you can always switch between A/B channel sources whenever it's pressed the following B button:

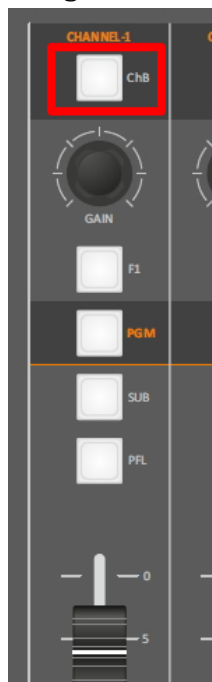

In this previous pictures we have taken Channel 1 as example. But the source change will be enabled on all of the available channels.

CHANNEL DEPENDENT: by pressing the above B channel button it is NOT allowed to switch between A/B channel sources while the channel is onair.

You will see the following error message into the HDMI output:

Cannot switch from/to ChB when channel is ON

Error displaying - HDMI OUTPUT - NORMAL MODE



Error displaying - HDMI MENU - SPECIAL MODE

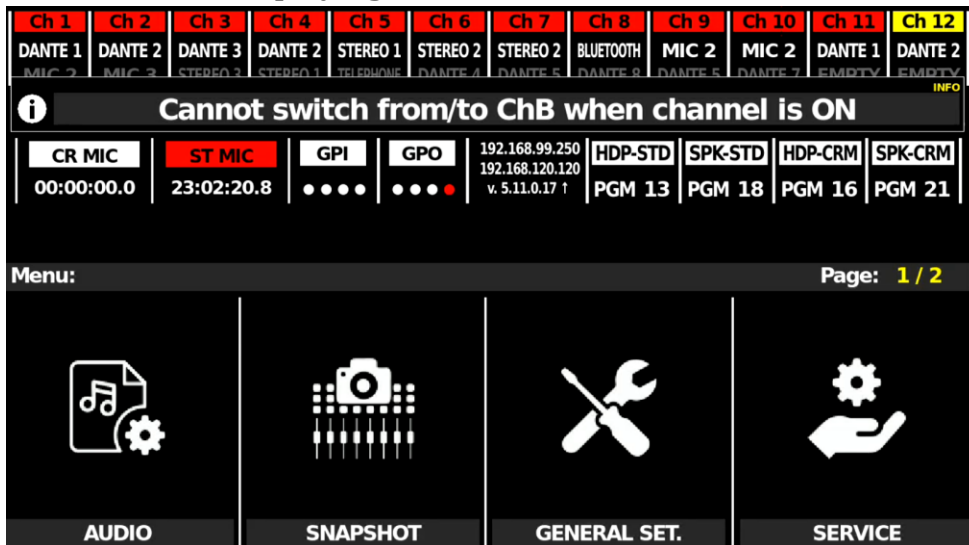

B button pressure on Oxygen Remoter makes it blink:



F. FADER THRESHOLD

The setting of this threshold parameter allows you to establish the minimum threshold of each fader, so that above it the channel is ON, below it the channel is OFF.



In this previous example every time the channel fader goes above -50 dB the channel will be activated. Every time the channel fader goes below -50 the channel will be deactivated.

G. LINE1 MODE

Line 1 could be used in one of the 3 following different modes:



STEREO (default input): 1 analog Stereo Input on 2 XLR Female (L & R) Balanced Audio Connection (10KΩ) on the connectors **ANALOG-IN-1**.

2 MONO (inputs): By selecting this option, instead of a stereo signal carried by ANALOG-IN-1 (L&R), you will be only able to choose **MONO 1** (ANALOG-IN-1-L) and **MONO 2** (ANALOG-IN-1-R).

2 Telco (inputs): By selecting this option instead of a stereo signal carried by ANALOG-IN-1 (L&R), you will be only able to choose **TELCO 2** (ANALOG-IN-1-L) and **TELCO 3** (ANALOG-IN-1-R).

H. LINE2 MODE

Line 2 could be defined in one of the 2 following modes:



STEREO (default input): 1 analog Stereo Input on RJ45 (SPTF cable) on the connector **ANALOG-IN-LINE-2**.

2 MONO (inputs): By selecting this option, instead of a stereo signal carried by ANALOG-IN-LINE-2 (with both Left-Right signal components), you will be only able to choose **MONO 3** (ANALOG-IN-LINE-2-L) and **MONO 4** (ANALOG-IN-LINE-2-R). The correct cable is described at the end of this user manual in the **+189 - Oxy1000-RJ45-Line** pinout scheme.

I. LINE3 MODE



STEREO (default input): 1 analog Stereo Input on RJ45 (SPTF cable) on the connector **ANALOG-IN-LINE-3**.

2 MONO (inputs): By selecting this option, instead of a stereo signal carried by ANALOG-IN-LINE-3 (with both Left-Right signal components), you will be only able to choose **MONO 5** (ANALOG-IN-LINE-3-L) and **MONO 6** (ANALOG-IN-LINE-3-R). The correct cable is described at the end of this user manual in the **+189 - Oxy1000-RJ45-Line** pinout scheme.

J. DANTE 1 MODE (IF THE CONSOLE HAS “DANTE OPTION”)

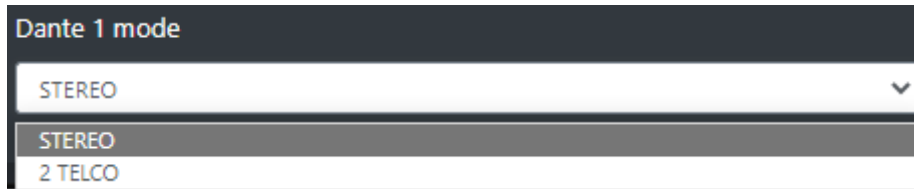

STEREO (default input): On the **DANTE-1-Input**, will be carried 1 Digital Stereo Signal on RJ45 (CAT 6 cable) on the connector **AOIP**. The same RJ45 cable also carries the other 7 DANTE INPUTS (DANTE 2 / 3 / 4 / 5 / 6 / 7 / 8)

2 Telco (inputs): By selecting this option instead of a stereo signal carried by DANTE 1(L&R), you will be only able to choose **TELCO 4** (DANTE-IN-1-L) and **TELCO 5** (DANTE-IN-1-R).

4.7.1.2 VJ PRO MODE

If you have the Axel Technology **VJPRO Console** software this will be the REMOTER section for the console Channel controllers of **VJPRO**.

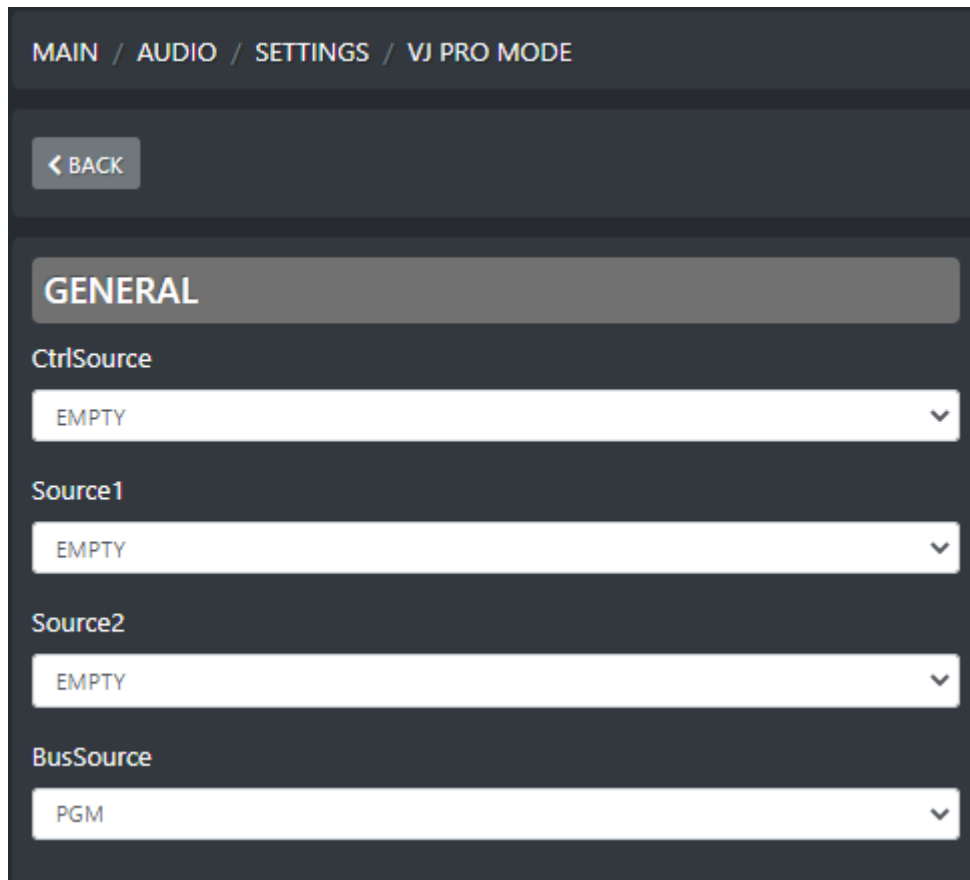

CTRL-SOURCE: The **DJPro** (Radio side) audio source is rooted automatically in the PGM. We suggest you to select **USB AUDIO-1**.

SOURCE-1: First **VjPro Console** (TV side) audio source, in this channel you have a clip related to the DjPro song. The Audio rooting is specified by the last BUS-SOURCE parameter. We suggest you to select **LINE-4**.

SOURCE-2: Second **VjPro Console** (TV side) audio source, in this channel you have a preloaded clip of the LINE-4 next clip. Useful source if the radio song length is shorter than the TV clip length. The Audio rooting is specified by the last BUS-SOURCE parameter. We suggest you select **LINE-5**.

BUS-SOURCE: **General TV audio BUS** for SOURCE-1(LINE-4) and for SOURCE-2(LINE-5). We suggest you select **AUX-1**.

4.8 GENERAL

4.8.1 GPIO

pinout scheme for the OXYGEN 1000/OXYGEN 2000 GPIO Sub-D9 port:

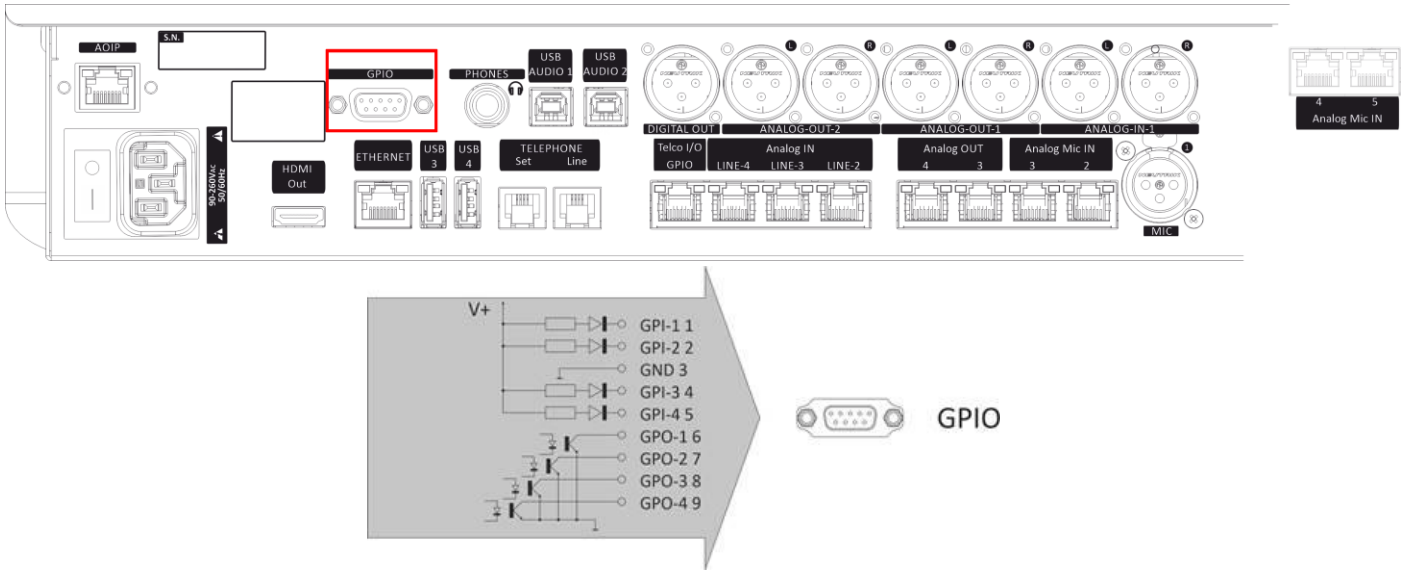

Through this SUB-D9 connector you can carry all of the 4 GPIs (GPI 1, 2, 3, 4) and all of the 4GPOs (GPO 1, 2, 3, 4)

HDMI-OUTPUT displaying of the activated GPI 1

	MIC2	MIC3	GPIO	OUT-3	OUT-4	TELCO
GPI			●			
GPO						

HDMI-OUTPUT displaying of the activated GPI 2

	MIC2	MIC3	GPIO	OUT-3	OUT-4	TELCO
GPI			●			
GPO						

HDMI-OUTPUT displaying of the activated GPI 3

	MIC2	MIC3	GPIO	OUT-3	OUT-4	TELCO
GPI			●			
GPO						

HDMI-OUTPUT displaying of the activated GPI 4

	MIC2	MIC3	GPIO	OUT-3	OUT-4	TELCO
GPI			●			
GPO						

HDMI-OUTPUT displaying of the activated GPO 1

	MIC2	MIC3	GPIO	OUT-3	OUT-4	TELCO
GPI						
GPO			●			

HDMI-OUTPUT displaying of the activated GPO 2

	MIC2	MIC3	GPIO	OUT-3	OUT-4	TELCO
GPI						
GPO			●			

HDMI-OUTPUT displaying of the activated GPO 3



HDMI-OUTPUT displaying of the activated GPO 4



OXYGEN REMOTER displaying of the activated GPI 1



OXYGEN REMOTER displaying of the activated GPI 2



OXYGEN REMOTER displaying of the activated GPI 3



OXYGEN REMOTER displaying of the activated GPI 4



OXYGEN REMOTER displaying of the activated GPO 1



OXYGEN REMOTER displaying of the activated GPO 2



OXYGEN REMOTER displaying of the activated GPO 3



OXYGEN REMOTER displaying of the activated GPO 4

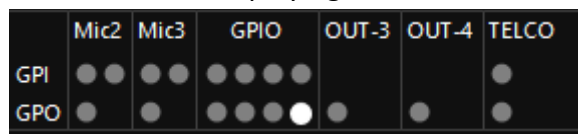

Pinout scheme for the OXYGEN 1000 / OXYGEN 2000 Telco I/O GPIO port

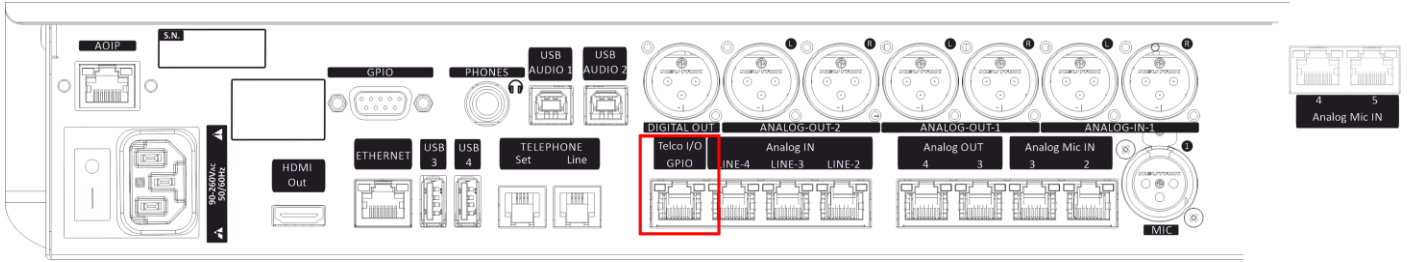

Also in the **+188 – Oxy1000-Oxy2000-RJ45-Telco** scheme at the bottom of this user manual

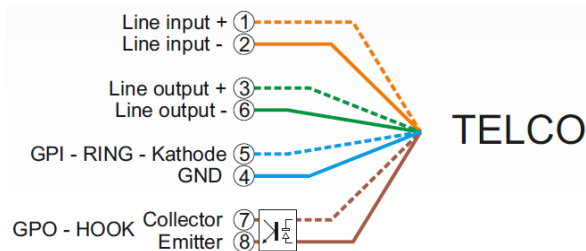
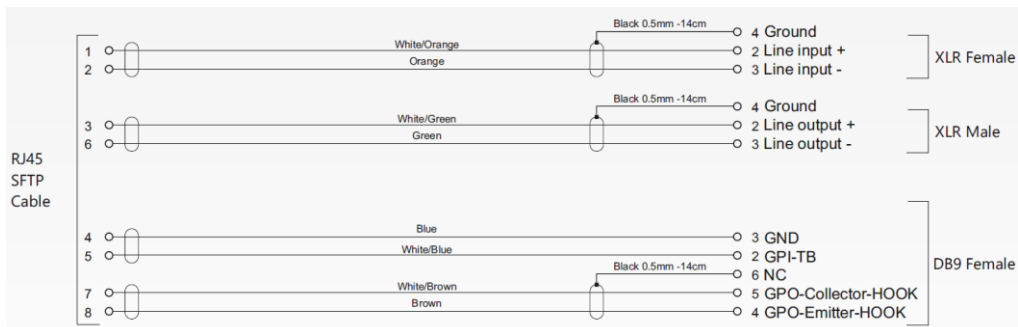
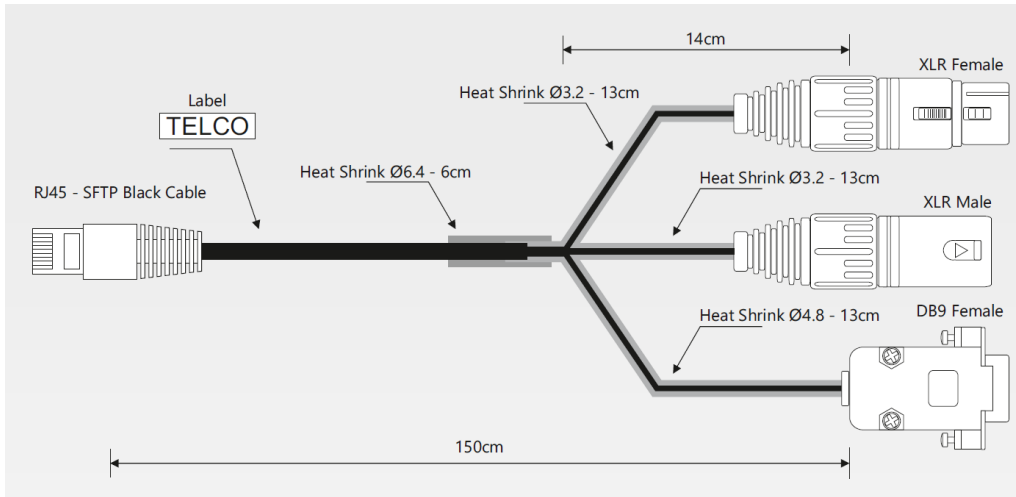

Through this RJ45 connector you can carry

- the GPI for the RING from the external TELCO (GPI > TELCO 1)

HDMI-OUTPUT displaying of the activated GPI

	MIC2	MIC3	GPIO	OUT-3	OUT-4	TELCO
GPI	●	●	●	●	●	●
GPO	●	●	●	●	●	●

OXYGEN REMOTER displaying of the activated GPI

	Mic2	Mic3	GPIO	OUT-3	OUT-4	TELCO
GPI	●●	●●	●●●●			●
GPO	●	●	●●●●	●	●	●

- the GPO for the line HOOK to the external TELCO (GPO > TELCO 1)

HDMI-OUTPUT displaying of the activated GPO

	MIC2	MIC3	GPIO	OUT-3	OUT-4	TELCO
GPI	●	●	●	●	●	●
GPO	●	●	●	●	●	●

OXYGEN REMOTER displaying of the activated GPO

	Mic2	Mic3	GPIO	OUT-3	OUT-4	TELCO
GPI	●●	●●	●●●●			●
GPO	●	●	●●●●	●	●	●

Pinout scheme for the OXYGEN 1000 / OXYGEN 2000
ANALOG OUT 3 and ANALOG OUT 4 RJ45 connectors:

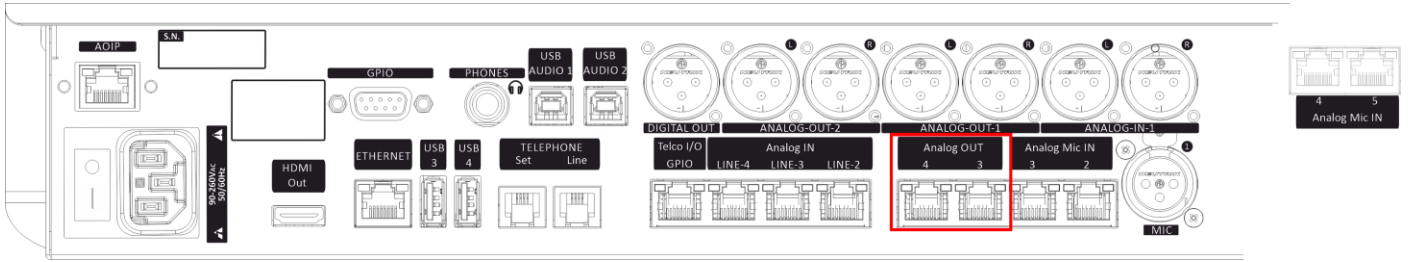

Also in the **+190 – Oxy1000-Oxy2000-RJ45-LineOut** scheme at the bottom of this user manual

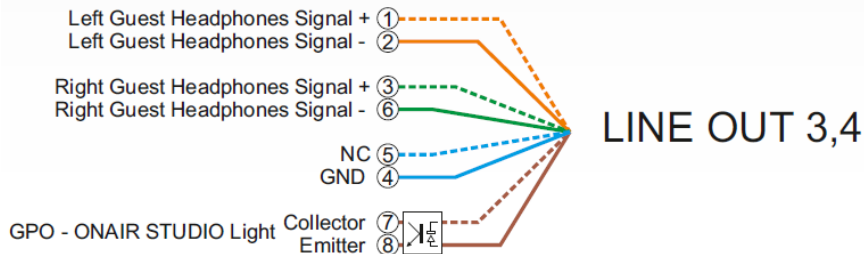
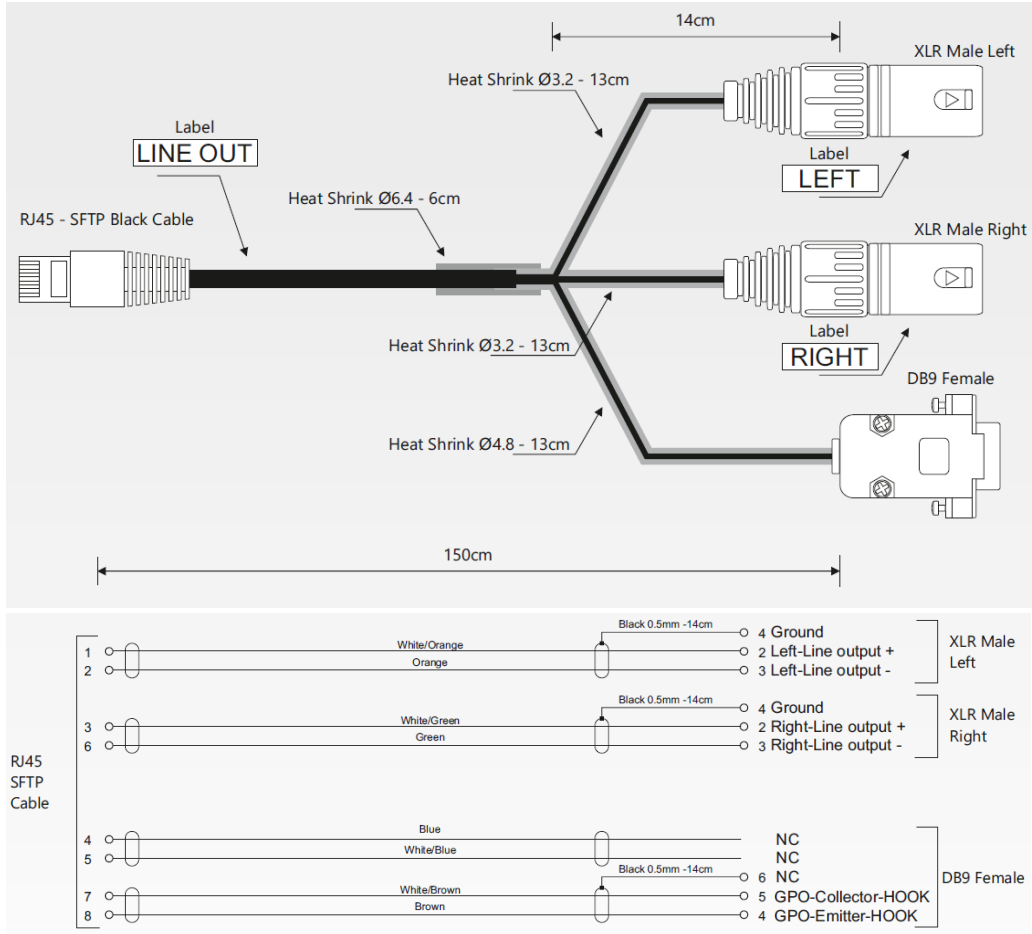

Through this RJ45 connector you can carry

- the GPO signal forwarded to the ONAIR LIGHT (or forwarded to the Axel TALKBOX if the light is connected to it)

HDMI-OUTPUT displaying of the activated OUT3 GPO



HDMI-OUTPUT displaying of the activated OUT4 GPO



OXYGEN REMOTER displaying of the activated OUT 3 GPO



OXYGEN REMOTER displaying of the activated OUT 4 GPO

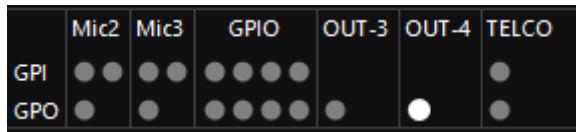

OXYGEN REMOTER > SETUP > GENERAL > GPIO

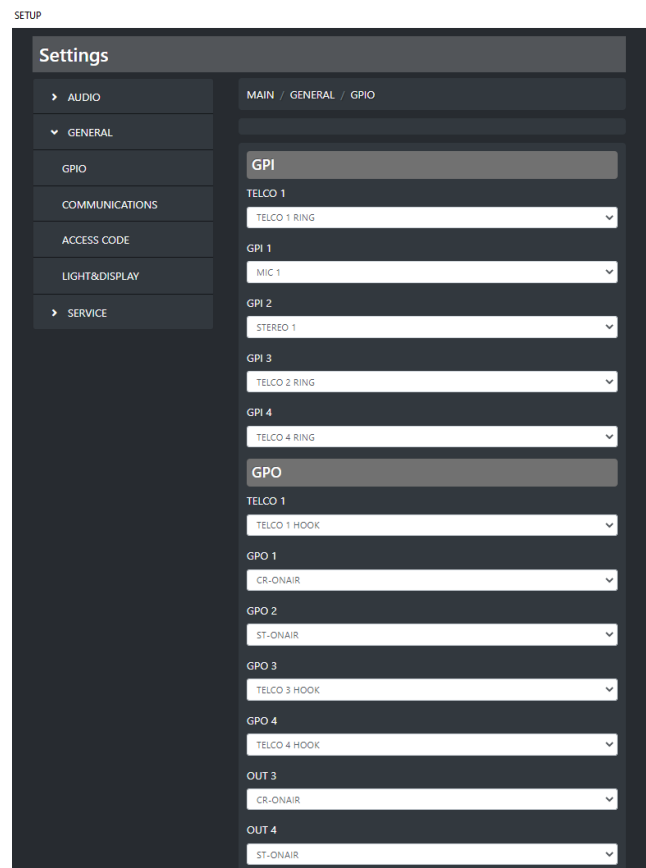

From this previous OXYGEN REMOTER panel at this MAIN / GENERAL / GPIO menu path, you can decide:

- Which incoming GPI signal triggers an internal console audio source or which GPI signal triggers an internal console event
- Which GPO signal outcomes from the console after a console audio source activation or which GPO signal outcomes from the console after a console event
- What incoming TELCO-1 GPI signal triggers in the console (audio source activation, or internal console event). The RING signaling from external TELCO is generally assigned by default.
- What audio source activation, or what internal console event generates the TELCO-1 GPO signal. The HOOK signaling to the external TELCO is generally assigned by default
- Which OUT-3 / OUT-4 GPO signal outcomes from the console after a console audio source activation or which OUT-3 / OUT-4 GPO signal outcomes from the console after a console event.
 - The CR-ONAIR signaling to the group of Control Room lights is generally assigned by default to OUT-3.
 - The ST-ONAIR signaling to the group of Studio lights is generally assigned by default to OUT-4.

4.8.1.2 GPI

The screenshot shows a vertical list of settings for GPI. At the top is a header 'GPI'. Below it are five sections, each with a dropdown menu:

- TELCO 1**: TELCO 1 RING
- GPI 1**: MIC 1
- GPI 2**: STEREO 1
- GPI 3**: TELCO 2 RING
- GPI 4**: TELCO 4 RING

TELCO 1

The screenshot shows a dropdown menu for 'TELCO 1' with the selected option being 'TELCO 1 RING'.

Select:

- which is the audio source to be activated.
- which internal console event has to be started (by default TELCO-1 RING)

at the receiving of the TELCO 1 GPI signal

GPI 1

The screenshot shows a dropdown menu for 'GPI 1' with the selected option being 'MIC 1'.

Select:

- which is the audio source to be activated
- which internal console event has to be started

at the receiving of the GPI 1 signal

GPI 2

The screenshot shows a dropdown menu for 'GPI 2' with the selected option being 'STEREO 1'.

Select:

- which is the audio source to be activated
- which internal console event has to be started

at the receiving of the GPI 2 signal

GPI 3

The screenshot shows a dropdown menu for 'GPI 3' with the selected option being 'TELCO 2 RING'.

Select:

- which is the audio source to be activated
- which internal console event has to be started

at the receiving of the GPI 3 signal

GPI 4

GPI 4

TELCO 4 RING
 ▼

Select:

- which is the audio source to be activated
- what internal console event has to be started

at the receiving of the GPI 4 signal

4.8.1.3 GPO

TELCO 1

TELCO 1

TELCO 1 HOOK
 ▼

Select:

- which audio source activation
- which internal console event
(by default TELCO 1 HOOK)

will generate the forwarding of the TELCO 1 GPO signal

GPO 1

GPO 1

CR-ONAIR
 ▼

Select:

- which audio source activation
- which internal console event

will generate the forwarding of the GPO 1 signal

GPO 2

GPO 2

ST-ONAIR
 ▼

Select:

- which audio source activation
- which internal console event

will generate the forwarding of the GPO 2 signal

GPO 3

GPO 3

TELCO 3 HOOK
 ▼

Select:

- which audio source activation
- which internal console event

will generate the forwarding of the GPO 3 signal

GPO 4



A screenshot of a configuration dropdown menu for 'GPO 4'. The menu is dark grey with a white text box containing 'TELCO 4 HOOK' and a small downward arrow on the right side.

Select:

- which audio source activation
- which internal console event

will generate the forwarding of the GPO 4 signal

OUT 3



A screenshot of a configuration dropdown menu for 'OUT 3'. The menu is dark grey with a white text box containing 'CR-ONAIR' and a small downward arrow on the right side.

Select:

- which audio source activation
- which internal console event
(By default CR-ONAIR)

will generate the forwarding of the OUT 3 GPO signal

OUT 4



A screenshot of a configuration dropdown menu for 'OUT 4'. The menu is dark grey with a white text box containing 'ST-ONAIR' and a small downward arrow on the right side.

Select:

- which audio source activation
- which internal console event
(By default ST-ONAIR)

will generate the forwarding of the OUT 4 GPO signal

4.8.2 COMMUNICATIONS

From this menu it is possible to manage everything related to console communications

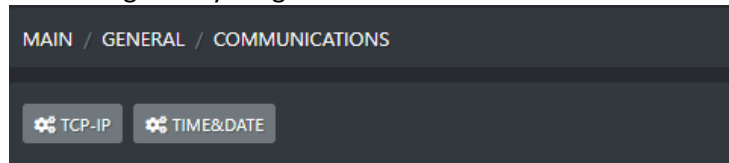

4.8.2.2 TCP-IP

By entering the TCP-IP section you will be able to manage everything concerning the reachability of the console itself within your LAN.

An IP Address could be assigned to the console, through which the same console can be reached.

The IP Address assignment can be automatic in the case of DHCP activation, or can be manual in the case you want to decide a desired specific IP address.

The console is also equipped with a second IP which, however, we recommend to keep unchanged on the address **192.168.120.120**, so that the Axel Technology - Technical Support can intervene in case of urgent need.

For the console to function properly, if DHCP is not enabled, it is recommended to configure the Gateway and DNS.

The **DNS** configuration is also important to allow the console to check the availability of any firmware updates which will then be downloaded from the internet.

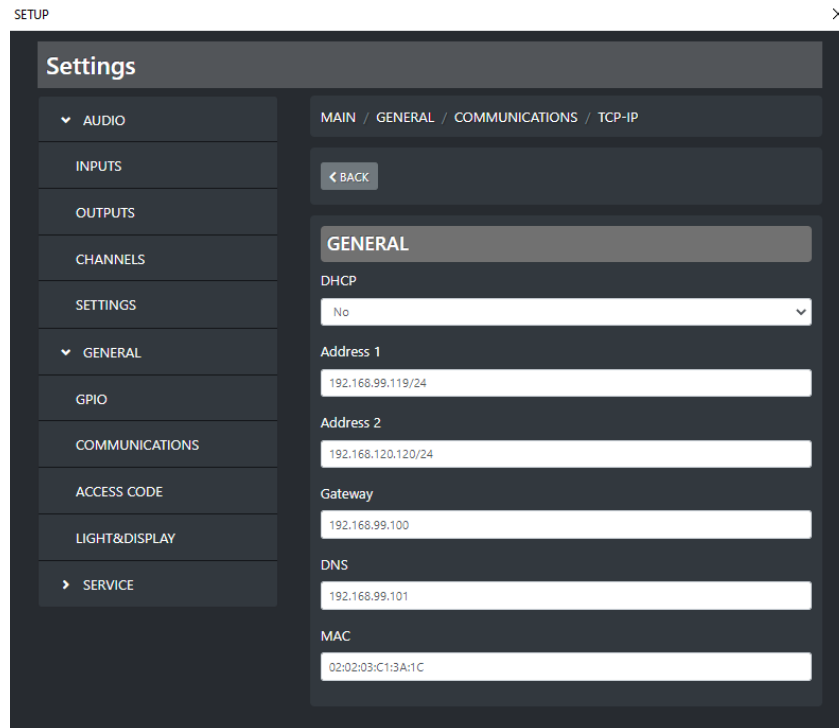

DHCP:

- if **Yes** is selected the IP address of the console will be automatically assigned by the router
- if **No** is selected you need to assign the desired console IP Addresses (we kindly advise you to keep the default one on Address 2)

ADDRESS 1: If DHCP=NO, type the desired IP Address that you want to assign to the console
ADDRESS 2: If DHCP=NO, type the desired secondary IP Address that you want to assign to the console. As already explained before, we kindly advise you to keep the the default 192.168.120.120)

GATEWAY: If DHCP=NO, type your Net/SubNet gateway

DNS: If DHCP=NO, type your DNS to access the Internet

MAC: Mac-Address of your console, the parameter could not be customized by the user

4.8.2.3 TIME&DATE

The current date and time of the console can be set in 2 different ways:

- in manual mode and configurable by the user himself
- in automatic mode and synchronized to an external and set NTP Server.

These dates and times become very important for the correct saving of the logs of the operation of the console itself.

By OXYGEN REMOTER this data is also useful to the console user when a program is on air.

This time/date will also be displayed in the connected HDMI Display and on OXYGEN REMOTER users:



OXYGEN REMOTER > SETUP > GENERAL > COMMUNICATIONS > TIME&DATE

The screenshot shows the 'Settings' window for 'TIME&DATE'. On the left is a sidebar menu with categories: AUDIO, INPUTS, OUTPUTS, CHANNELS, SETTINGS, GENERAL (expanded), GPIO, COMMUNICATIONS, ACCESS CODE, LIGHT&DISPLAY, and SERVICE. The main content area shows a breadcrumb trail: MAIN / GENERAL / COMMUNICATIONS / TIME&DATE. Below this is a '< BACK' button. The 'GENERAL' section includes: 'Current Time' (text input: 01/31/2022 12:54), 'Date format' (dropdown: MM/DD/YYYY), 'Time format' (dropdown: 24h), and 'Time zone' (dropdown: (UTC+01:00) Amsterdam, Berlin, Bern, Rome, Stockholm, Vienna). The 'NTP' section includes: 'NTP Enable' (dropdown: Yes) and 'NTP Address' (text input: 217.147.223.78).

NTP ENABLE:

By choosing Yes, the console data & time will be automatically synchronized to a desired external NTP Server. By choosing No, the user can manually assign to the console the desired data and time

CURRENT TIME:

If NTP ENABLE = No, set here the desired current date and time

DATE FORMAT

If NTP ENABLE = No, select the desired date format between the available ones.

TIME FORMAT

If NTP ENABLE = No, select the desired time format between the available ones.

TIME ZONE

If NTP ENABLE = No, select the desired time zone between the available ones.

NTP ADDRESS:

If NTP ENABLE = Yes, set here the IP Address of your chosen NTP Server

4.8.2.4 ACCESS CODE

The Oxygen console gives the user the ability to lock the settings with a passcode to prevent any modifications by unauthorized persons.

There are two different Access Codes (4-digit PIN) to help you if one of the two passcodes is forgotten

- Two different Passcode
- The default passcode is 0000
- It can disable and enable both of them together by ON/OFF selection.
- Can set the passcode to lock the display after 10, 30, or 60 minutes

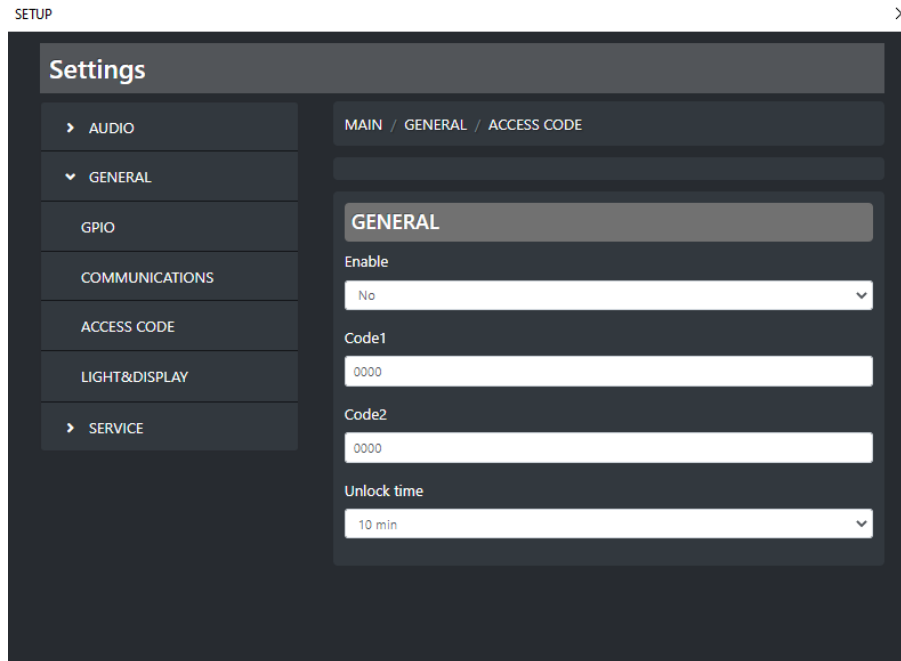

ENABLE:

- If No is selected, the console will never be locked
- If Yes is selected, the console will be locked after the **Unlock Time** selected in the last parameter of this section. After the **Unlock Time**, the console needs **CODE1** or **CODE2** to be unlocked successfully

CODE1: If **ENABLE = YES**, here you can set the primary desired code to Unlock the console after **Unlock Time** will be passed

CODE2: if **ENABLE = YES**, here you can set the secondary desired code to Unlock the console after **Unlock Time** will be passed.

UNLOCK TIME: Select between the available options the time after you want the console will be automatically locked. Choosable options are 10 min, 30 min, 60 min.

4.8.2.5 LIGHT&DISPLAY

From the following menu sub-sections you can set the led colors and the led brightness. It is also possible to choose between the different HDMI output layouts available.

LIGHT

As you can see by the 2 pictures below, in this section the user can customize the **light intensity of buttons**. By this sub-menu it is also possible to set customizable colors for **MUTE**, **PFL**, and **MENU**. Both changes will affect the **OXYGEN 1000/OXYGEN 2000** surface and **OXYGEN REMOTER**

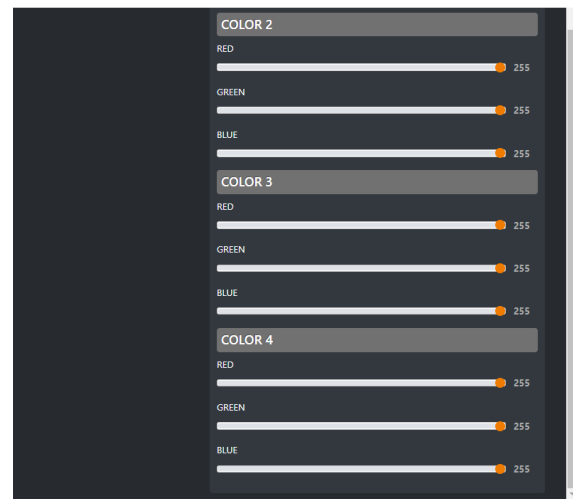
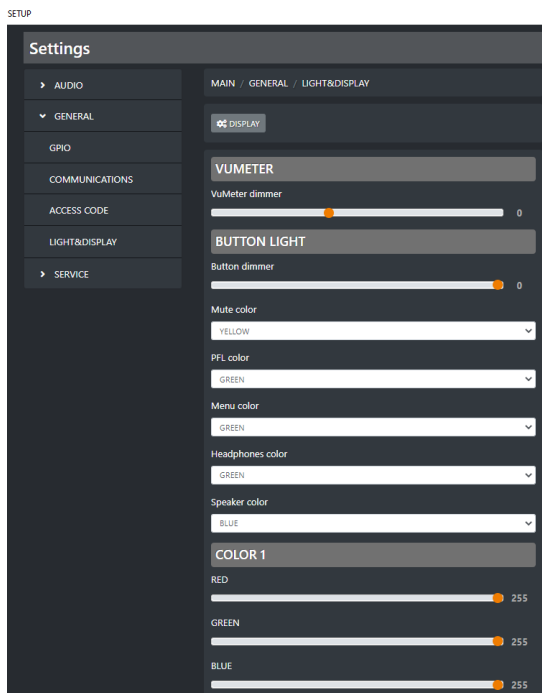

VUMETER

By the following **VUMETER dimmer** slider the user can adjust the VuMeter light intensity. Changes will affect hardware dimmers on the console surface and software dimmers on the OXYGEN REMOTER software.

Min **VUMETER dimmer** value = -2

Max **VUMETER dimmer** value = 3

Default **VUMeter dimmer** value = 0



BUTTON LIGHT

Assign the desired color for

- MUTE buttons
- PFL buttons
- General console buttons
- Headphones source selection
- Speaker source selection

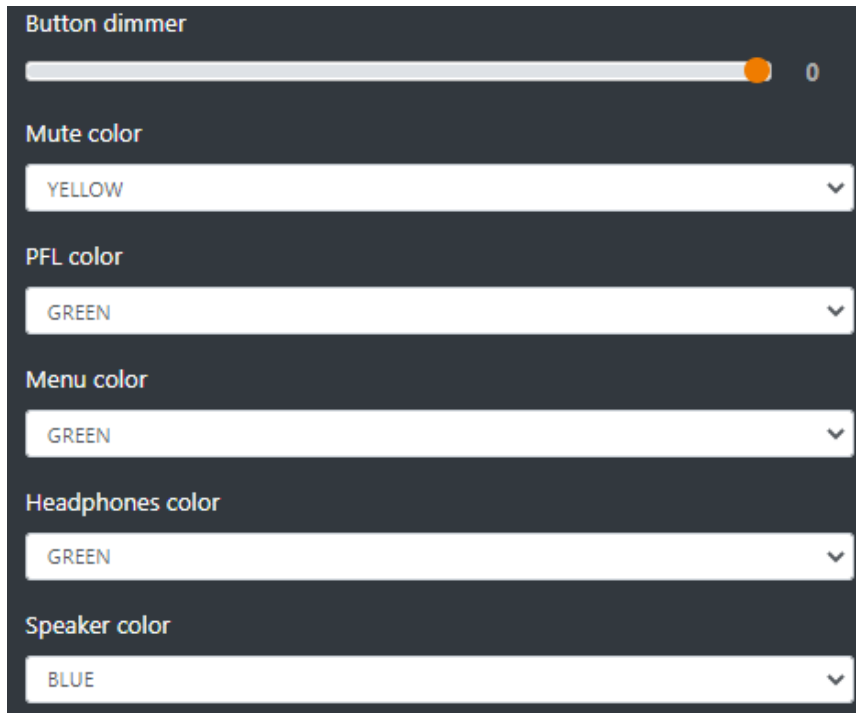

Choosable default-colors are:

RED
 BLUE
 GREEN
 YELLOW
 CYAN
 MAGENTA
 WHITE

The user can also choose up to the 4 additional customizable RGB colors:

COLOR 1
 COLOR 2
 COLOR 3
 COLOR 4

In the following lines the way how you can adjust the RED, GREEN, BLUE components for each of these 4 customizable colors.

COLOR 1/2/3/4

There are also 4 editable colors (color-1 to 4) available.
An RGB color value is specified with RGB (red, green, blue).

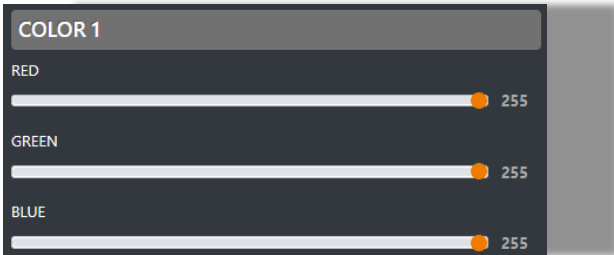

Each parameter (**red**, **green**, and **blue**) defines the intensity of the color as an integer between **0** and **255**.
For example, RGB (**0**, **0**, **255**) is rendered as **blue**, because the **blue** parameter is set to its highest value (**255**) and the others are set to **0**.

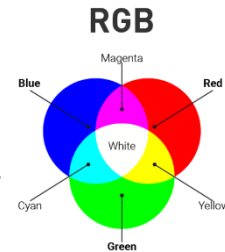

Just for example:

R	255	255	255	125	0	0	0	0	0	125	255	255
G	0	125	255	255	255	255	125	0	0	0	0	0
B	0	0	0	0	0	125	255	255	255	255	255	125

DISPLAY

By pressing the following  **DISPLAY** button:

SETUP

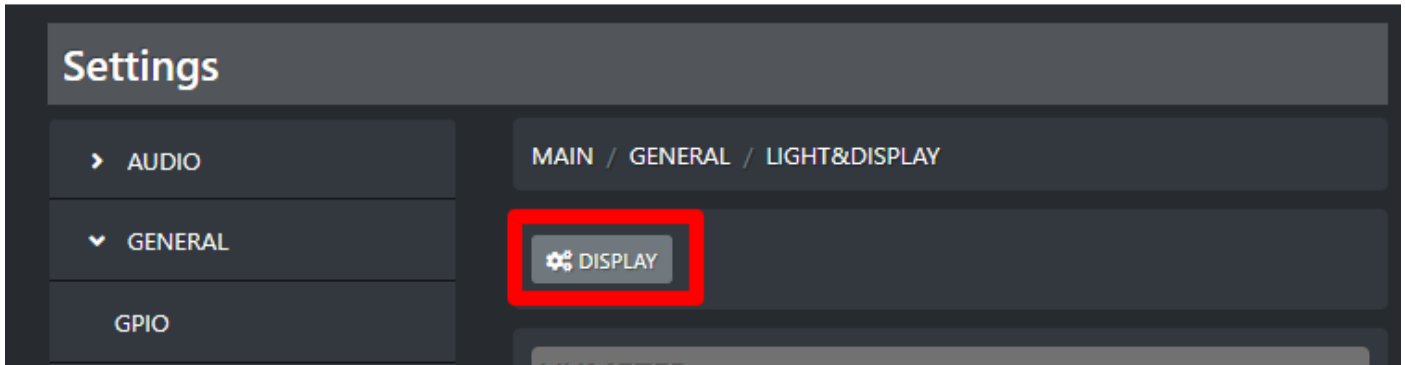

You will be directed in the following **HDMI Layout** selection. Between available layouts, select the one you want to apply to your HDMI:

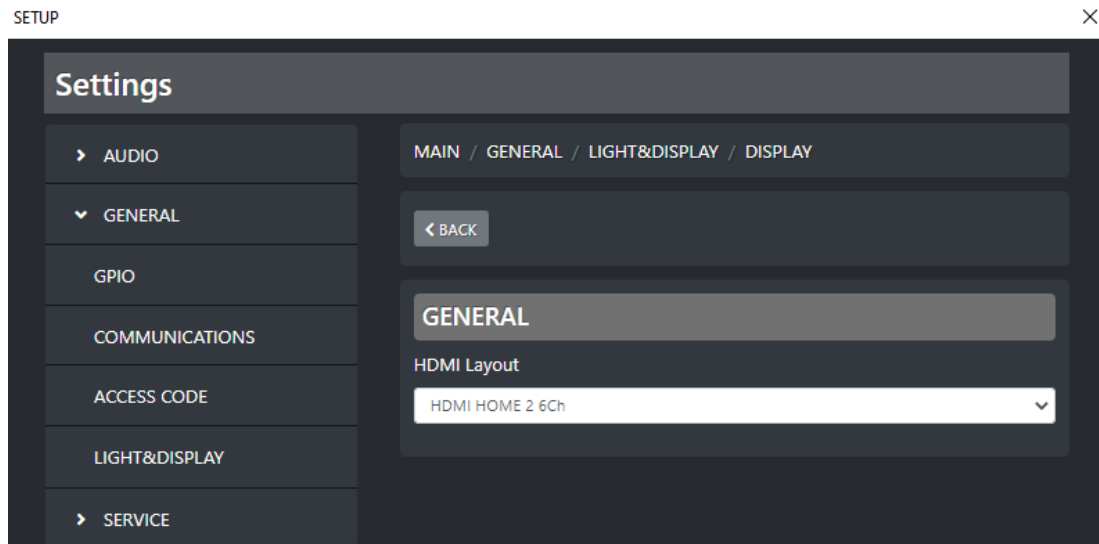

Choosable options are:

HDMI HOME 1
 HDMI HOME 2 6Ch
HDMI HOME 2 12Ch
 HDMI HOME 3
TEST PAGE

The TEST PAGE is a special test executable on your HDMI-output-display.

4.9 SERVICE

SERVICE ×

Configuration

Save your configuration: TO USB TO internal SD DOWNLOAD

Restore your configuration: FROM USB FROM internal SD UPLOAD FILE

Upload Logo: No file chosen UPLOAD LOGO

Factory reset: RESET

Mixer Firmware

Release: CHECK RELEASE current version: 6.1.0.2 release

Remoter Software

Release: Download 5.11.0.3

Connected clients: FORCE DISCONNECT

Logs

Load logs:

Web Login

Change password to login: SAVE

4.5.1 CONFIGURATION

The first **Configuration** section allows you to:

- save the whole console configuration in all of its parameters
- restore the whole console configuration previously saved
- execute a factory reset on the console

4.9.1.1 SAVE YOUR CONFIGURATION



The configuration file will be saved into the plugged USB key. The USB are the ones squared in the following picture:

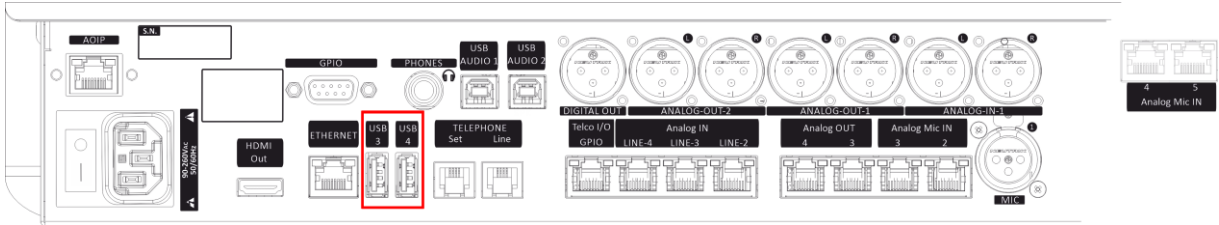

The configuration file will be saved into the console SD CARD. The SD is the memory containing the console firmware.



The configuration file will be saved locally in the current PC DOWNLOADS folder.

4.9.1.2 RESTORE YOUR CONFIGURATION

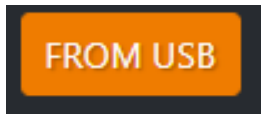

The console configuration will be restored from a configuration file saved into the plugged USB key. The USB ports are the ones squared in the following picture:

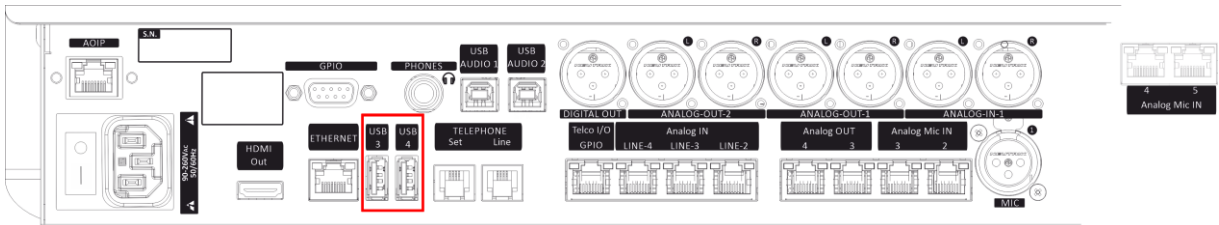

Select between the available .json configuration files:

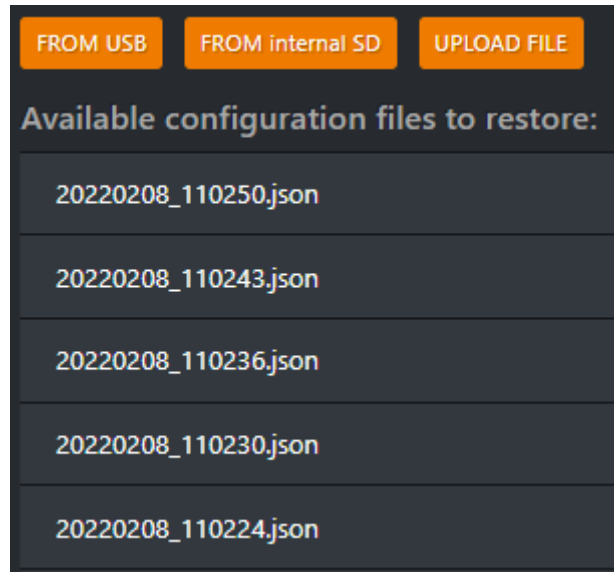

FROM internal SD

The configuration file will be restored from a configuration file saved into the console SD CARD.

Then select between the available .json configuration versions as shown by the following picture:

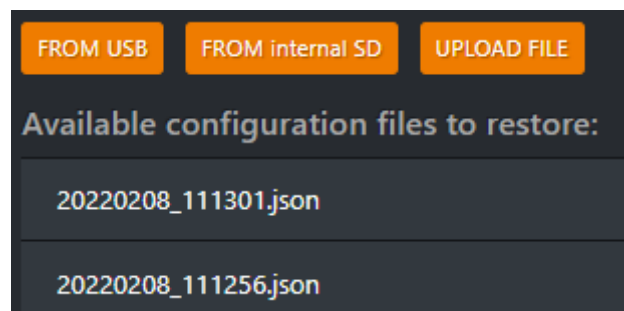

UPLOAD FILE

The console configuration will be restored by one of the configuration files previously saved into the local computer that you are currently use.

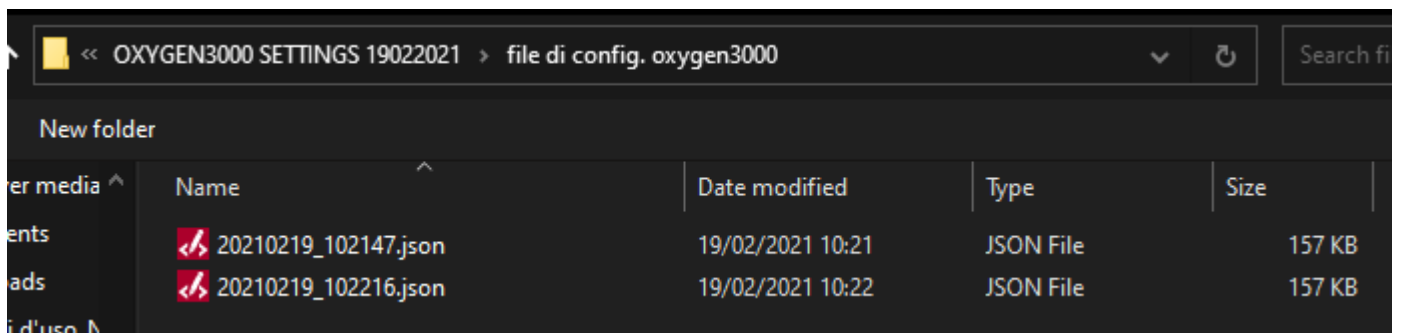

Between the available .json configuration files select the desired one.

4.9.1.3 EXECUTE A FACTORY RESET



By pressing this button the console configuration will be reset to factory. All the configurations previously stored into the internal SD card and the customized logo will be deleted. Attention to have stored a .json configuration file in the DOWNLOADS folder of your PC or to have stored it in a plugged USB stick.

4.9.1.4 LOGO CUSTOMIZATION

Press CHOOSE FILE as described by the image below:

SERVICE

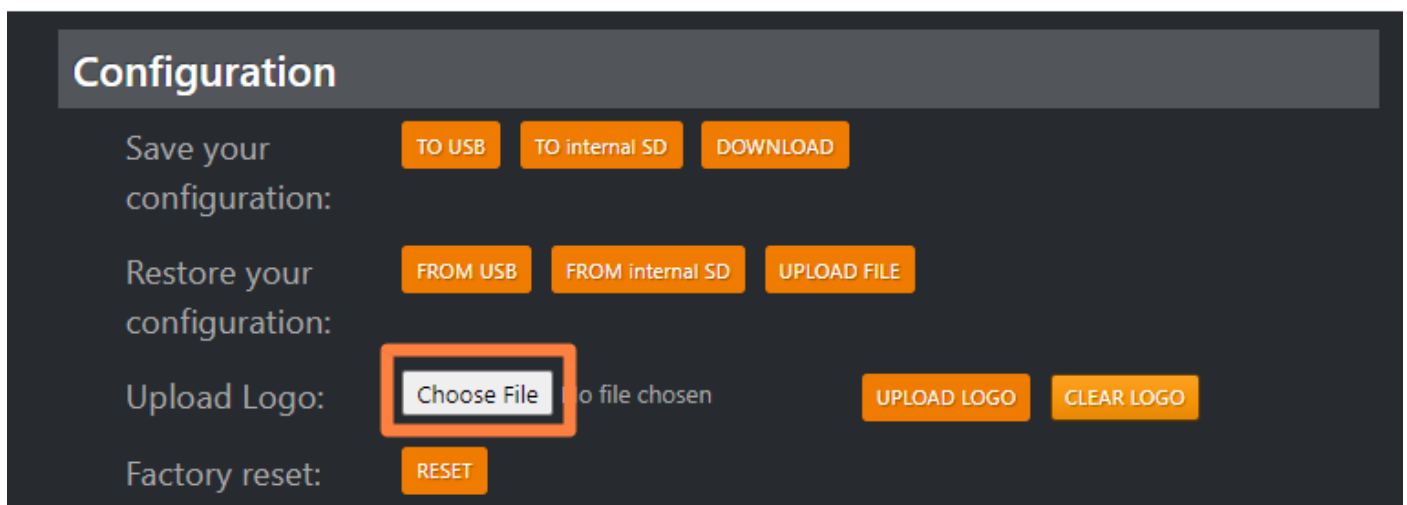

From your Windows folders select the desired logo.

The selected file will be displayed in the following position:

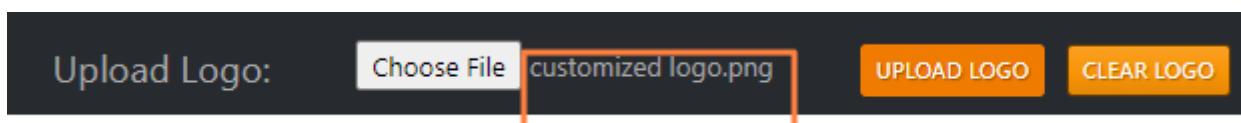

Press  to apply the selected one.

Press  to clear it.

ATTENTION: The only allowed extension for the logo file is the **.png** format.

The max allowed logo size is: **300x280 pixels**.

4.9.1.5 FIRMWARE

By this FIRMWARE section you can remotely update the **OXYGEN 1000** or **OXYGEN 2000** firmware version. To do that from the section



Press **CHECK RELEASE** and you will be able to read the firmware currently installed into the monitored **OXYGEN 1000** or **OXYGEN 2000** console:

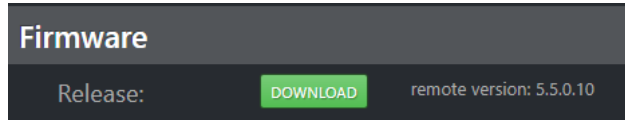

Press **DOWNLOAD** to latest available firmware version:

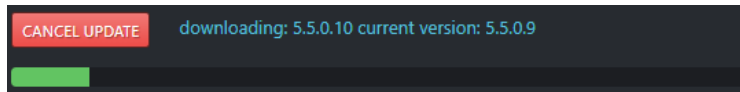

After the firmware download will be completed, you will see the progress bar of the file preparing process:

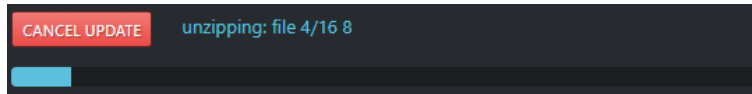

Press install to start the console upgrade:

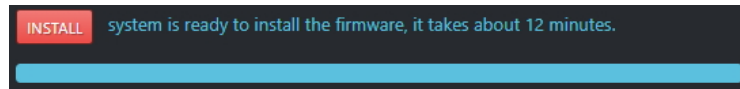

An updating firmware countdown will start as shown by the following picture:



After the end of this countdown follow the LCD display instructions.

Press SHUTDOWN by the LCD display

Reboot the console from the back panel power button.

4.9.1.6 SOFTWARE

The **Software** section allows you to know if there is a new software version of the **Oxygen Remoter** to be downloaded.

By here you can read the latest available software version:

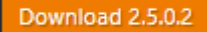

By pressing  you will automatically start the downloading process for the **OxygenRemoter.exe** setup file, as shown you in the following picture:

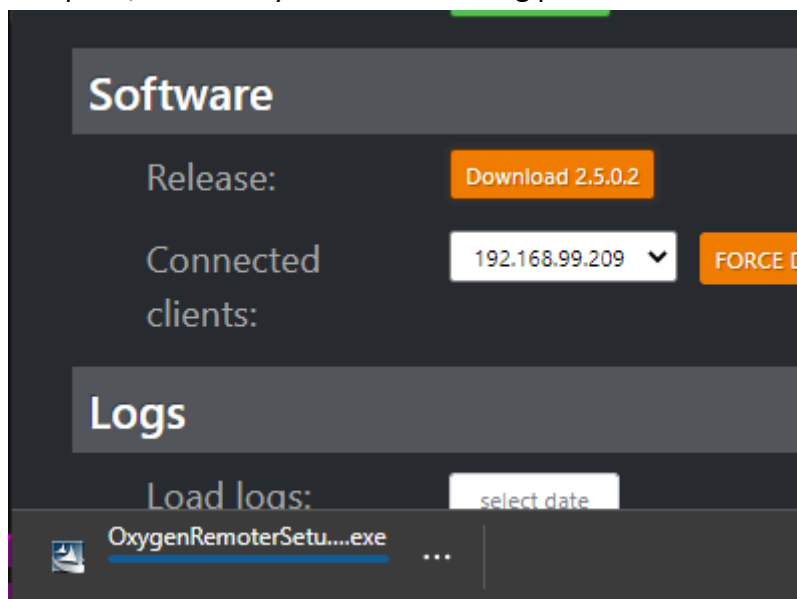

Run the downloaded .exe installer:

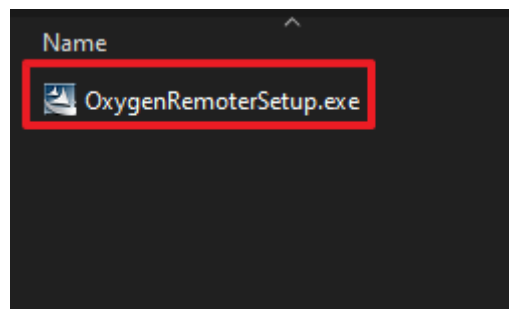

Select **REPAIR** as shown in the picture below:

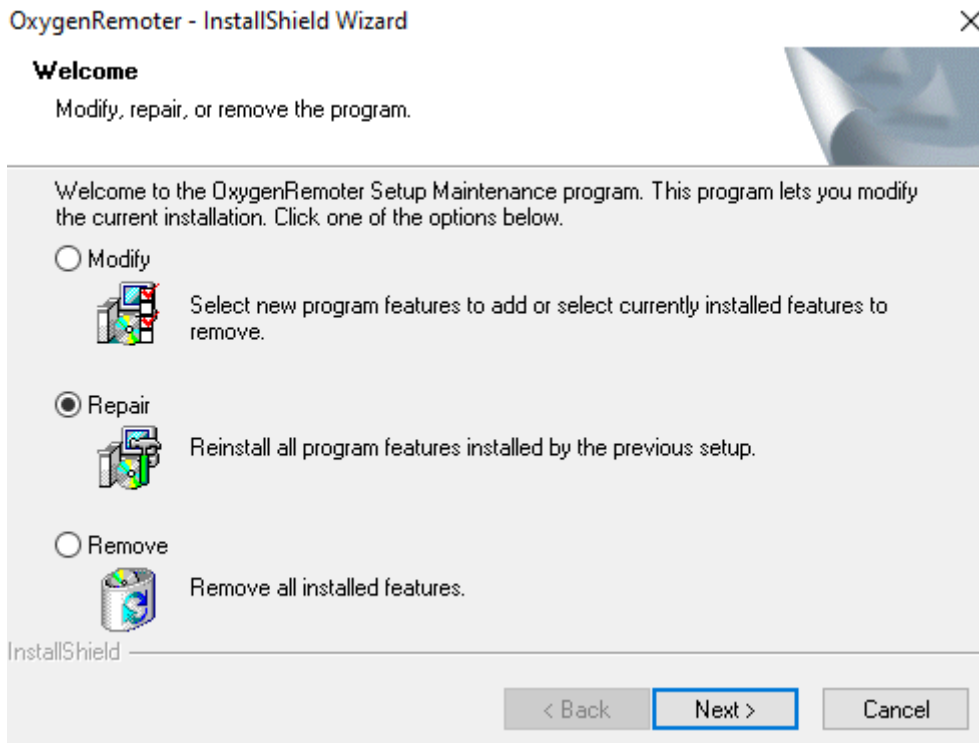

You can also proceed by downloading the latest **OxygenRemoter.exe** setup file from the following link:

<https://www.axeltechnology.com/Public/OxygenRemoter/OxygenRemoterSetup.exe>

By opening the following drop-down menu you can monitor which clients are currently connected to the same console by a different Oxygen Remoter session. In the following example you can see the 2 IP Addresses of the currently connected clients:

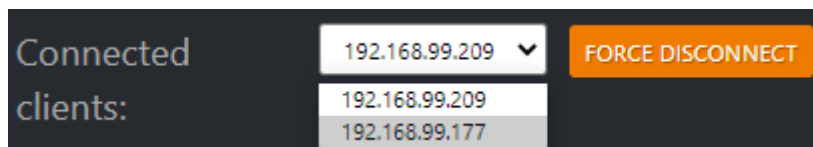

Select the client IP you want to disconnect and press

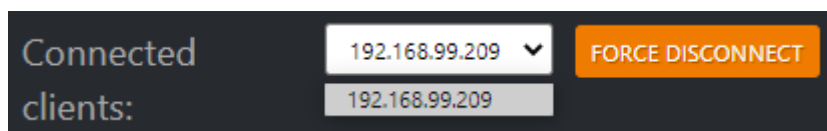

ATTENTION!!! Be careful not to ban yourself out by selecting your own client IP Address

4.9.1.7 LOGS

The **Logs** section allows you to read and download the desired date of the console Log:



Press to open the calendar:

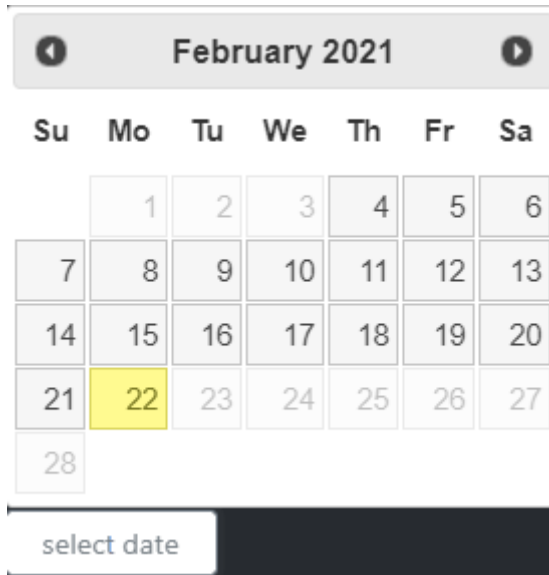

After the desired date selection you can easily read all the console Logs as shows by the following picture:

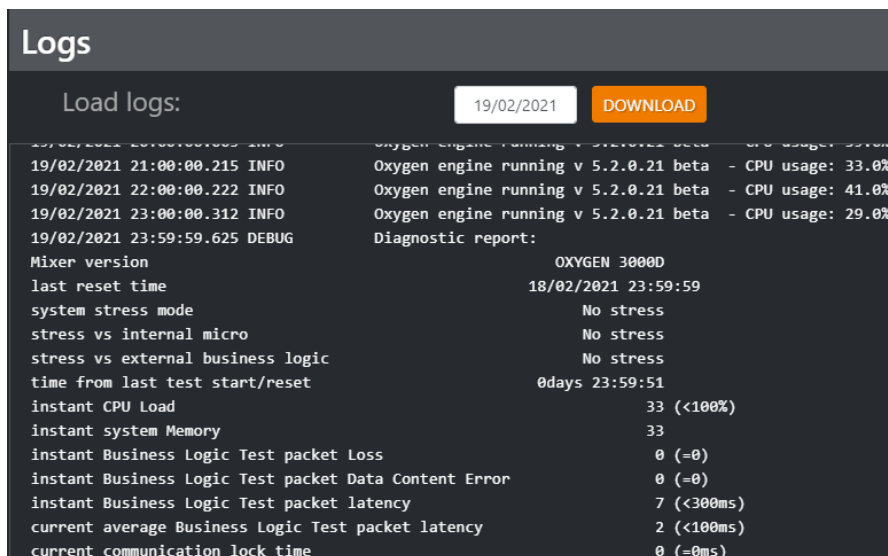

Press:





to export the Log File in .txt format:

```
19-02-2021.txt - Notepad
File Edit Format View Help
19/02/2021 21:00:00.215 INFO Oxygen engine running v 5.2.0.21 beta - CPU usage: 33.0%
19/02/2021 22:00:00.222 INFO Oxygen engine running v 5.2.0.21 beta - CPU usage: 41.0%
19/02/2021 23:00:00.312 INFO Oxygen engine running v 5.2.0.21 beta - CPU usage: 29.0%
19/02/2021 23:59:59.625 DEBUG Diagnostic report:
Mixer version OXYGEN 3000D
last reset time 18/02/2021 23:59:59
system stress mode No stress
stress vs internal micro No stress
stress vs external business logic No stress
time from last test start/reset 0days 23:59:51
instant CPU Load 33 (&lt;100%)
instant system Memory 33
instant Business Logic Test packet Loss 0 (=0)
instant Business Logic Test packet Data Content Error 0 (=0)
instant Business Logic Test packet latency 7 (&lt;300ms)
current average Business Logic Test packet latency 2 (&lt;100ms)
current communication lock time 0 (=0ms)
channel Input Buffer Overflow 0 (=0)
master Input Buffer Overflow 0 (=0)
DSP Input Buffer Overflow 0 (=0)
channel Output Buffer Overflow 0 (=0)
master Output Buffer Overflow 0 (=0)
test time max CPU Load 93 (&lt;100%)
test time average CPU Load 63 (&lt;85%)
test time System Memory 34 (&lt;40%)
surface business logic test packet loss 0 (=0)
surface business logic test packet data content error 0 (=0)
surface business logic test packet latency max 388 (&lt;300ms) !
surface business logic test packet latency average 132 (&lt;100ms) !
```

4.9.1.8 WEB LOGIN

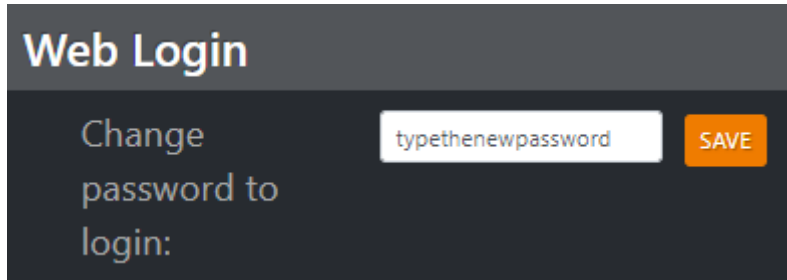
By this section you can change the Password for the OXYGEN REMOTER connection or to connect on the browser Web Page:



Type the new password in the fillable field and press  to confirm the change.

4.10 SMART KEY / JINGLE BUTTONS*

Smart Keys are 8 useful buttons available on **OXYGEN REMOTER**.



Their standard names are **K1, K2, K3, K4, K5, K6, K7** and **K8**, but their names can be totally customized how the user requires.

They can be used to make the same console itself send IP Commands in TCP or UDP or REST Api protocol to an external system as:

- an external software
- an external device

capable of reading the protocol of the command and capable of executing the command request.

The Oxygen Remoter allows you to set and manage 2 different kind of outgoing IP commands:

- The first one works with **SMART KEYS** and could be managed by Oxygen1000 or Oxygen2000 Smart Keys
- the second one works with **TRIGGER** and could be managed by the desired OXYGEN1000 or Oxygen2000 channel slider and related "ON/OFF buttons" = ON

4.6.1 DEVICES SECTION

In **DEVICES** section you can define the Remote Device where the desired *Remote Application* is installed:

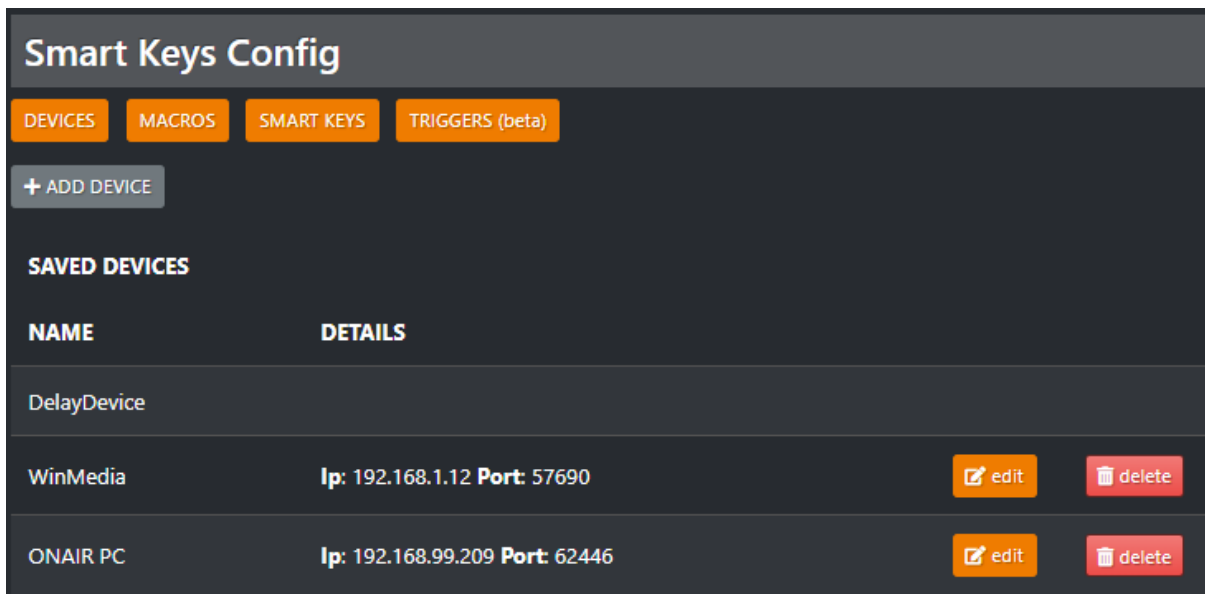

- Pressing **+ ADD DEVICE** to define all the communication parameters with your external device

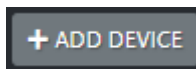

The next customizable fields will be displayed:

- b. Defining the **Remote Device / Application** that you want to control, by choosing between the following available:



- c. assigning a customizable **Name** of the *Remote Device/Application*

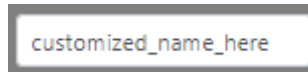

- d. typing the *Remote Device/Application IP Address*

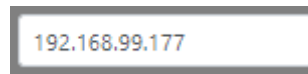

- e. selecting the **Port** for the communication (TCP or UDP or Rest API). The port is definable into the Remote Application, not by Oxygen Remoter.



After pressing **SAVE** the device will be added to your **DEVICE** list

SMART KEYS ×

Smart Keys Config

DEVICES
MACROS
SMART KEYS
TRIGGERS (beta)

+ ADD DEVICE

SAVED DEVICES

NAME	DETAILS		
DelayDevice			
WinMedia	Ip: 192.168.1.12 Port: 57690	edit	delete
ONAIR PC	Ip: 192.168.99.209 Port: 62446	edit	delete
customized_name_here	Ip: 192.168.99.177 Port: 8090	edit	delete

total: 4

Select an existing device to edit or to delete it.

The change will be applied only after **SAVE** button pressure.

4.6.2 MACROS SECTION

in **MACROS** section you can manage the command MACROS to be sent to the remote software / device.

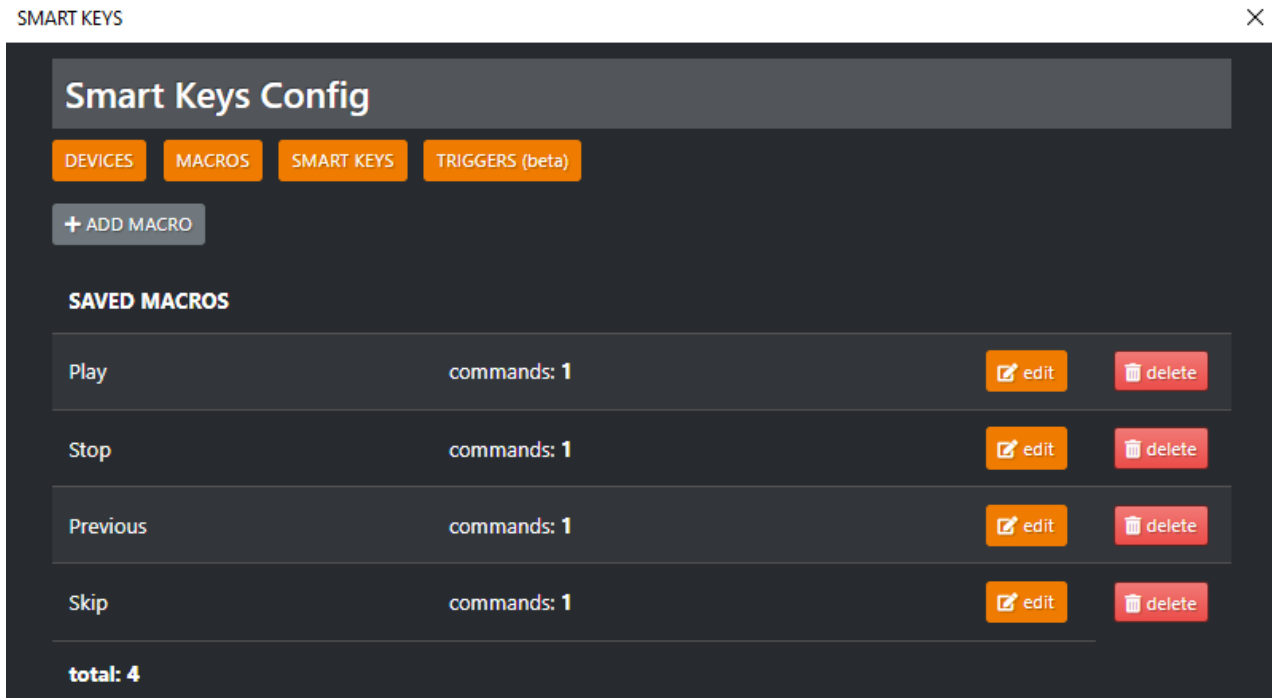

A single MACRO could be composed by one command or multiple commands. Multiple commands in a single MACRO are useful if you need to control 2 or more external softwares/devices in the same time.

*In example the **Play** macro at the same time sends the command **Play to YoupPlay** to one target device (in this case the target is an Axel production software called YouPlay) and the command **Video Switcher** to a different target device (in example a remotely controllable Video Switcher)*

The single MACRO can be programmed with N different commands. Each of these N commands can be sent to a different device / software, up to a maximum of N different reachable devices / software.

This was designed to allow the user to create more commands associated with a single MACRO. When the single SMART KEY (K1 or K2...or K8) is pressed, the associated MACRO can send more than one command simultaneously.

So one single SMART KEY in example is able to control 2 or more different software in the same PC, or 2 or more different software in 2 or more different PCs, or 2 or more different devices.

- a. Press + **ADD MACRO** to define a new MACRO

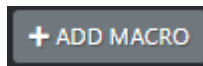

The next customizable section will be displayed:

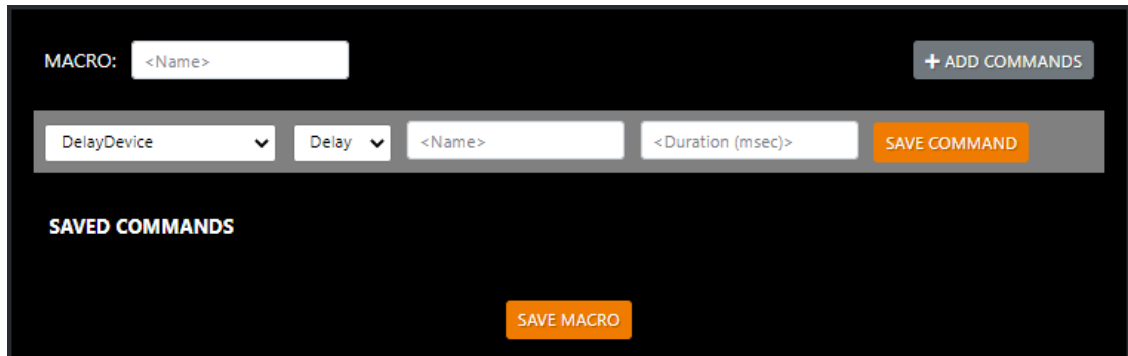

- b. Give a name to your MACRO by typing it in this field

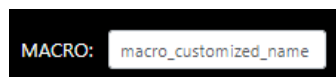

- c. The following top-right button will be displayed:



By pressing the +**ADD COMMANDS** button you can start defining one command or more to be associated with the current MACRO:



- d. Define the **Remote Device / Software** that you want to control, by choosing between the available ones in the following menu. The choosable options has to be previously set by the user in the **DEVICE** section:

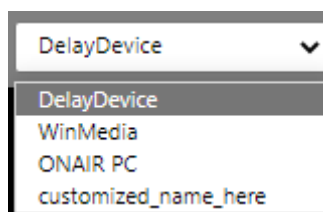

- e. From the menu below, choose the protocol of the command to be sent, between the 3 available ones:

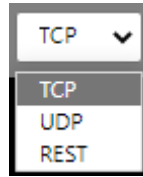

- f. type the desired command name in the next field here below:

- g. In case of a DELAY DEVICE the next field requires for a desired delay Duration (msec)

In case of other DEVICES or SOFTWARE that you want to control, the same field has to be filled with the command in the exact syntax specified to you by the producers of the external DEVICE or SOFTWARE.

ATTENTION: In the OXYGEN REMOTER, the **TCP** and **UDP** commands must be enclosed in quotation marks:

“ ”

For example, if the exact command syntax indicated by them is:

^^STARTNEXT

(this is an example taken from the commands accepted for example by our **DJPRO CLASSIC** or by **DJPRO ENTERPRISE** onair software),

in the OXYGEN REMOTER the same command has to be written as:

“^^ STARTNEXT”

Quotation marks, on the other hand, **should not be inserted for REST API commands.**

After pressing **SAVE COMMAND** the command will be added to your command list of the current **MACRO**:

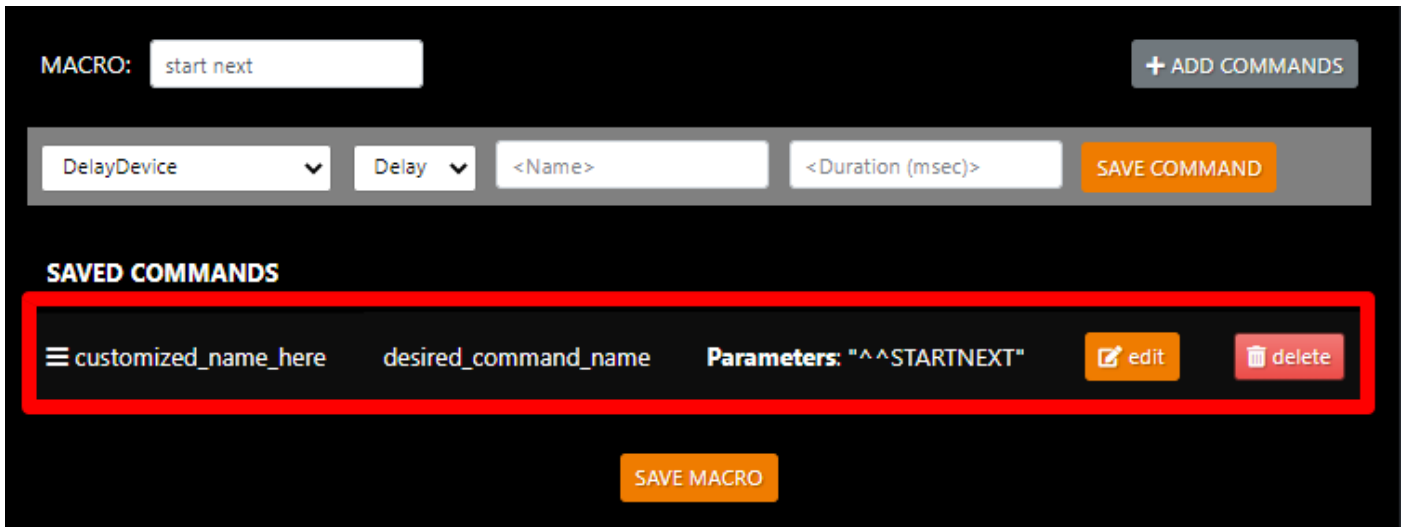

If you do not need other commands inside this MACRO you can proceed by pressing **SAVE MACRO**. Otherwise you can add a different command also pointing a different device and in a different protocol

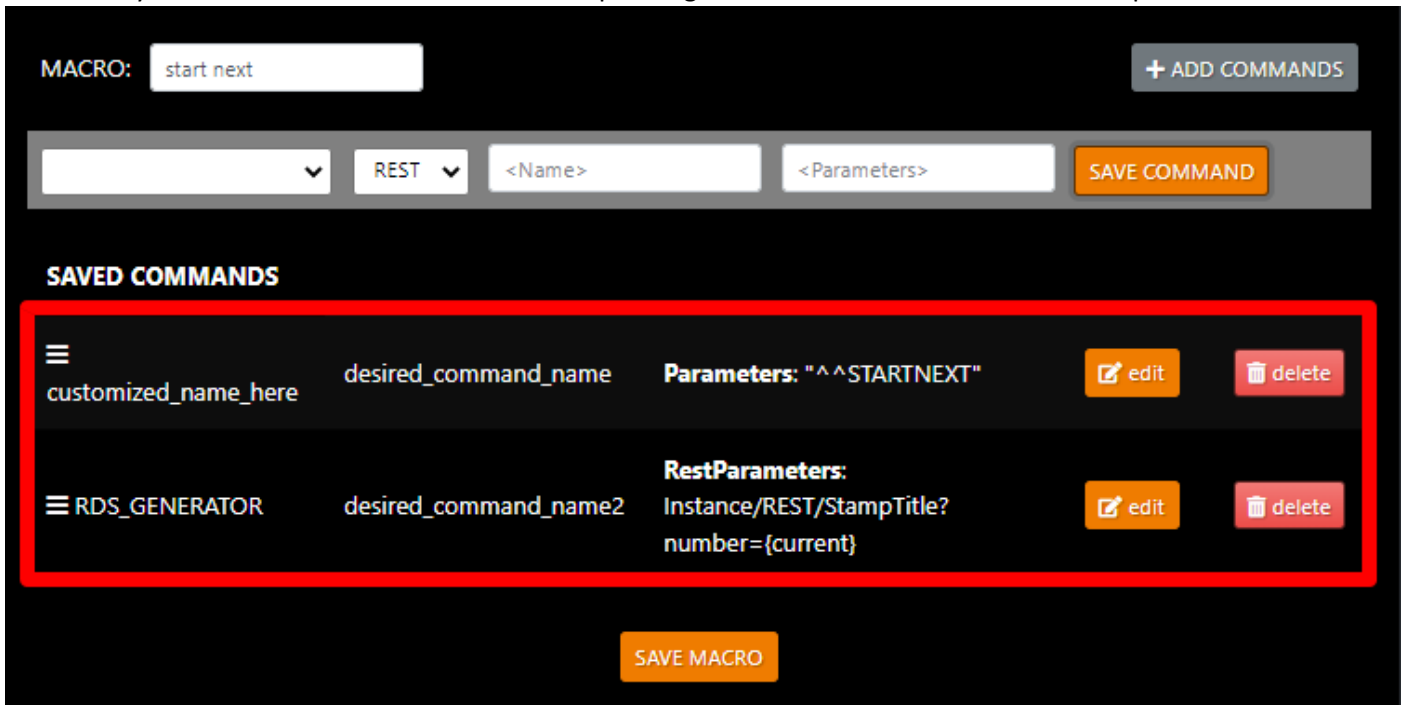

Press **edit** to edit your command or **delete** to delete it from your list.

The change will be applied only:

- after **SAVE COMMAND** button pressure
- AND
- after **SAVE MACRO** button pressure.

Then the MACRO can be recalled easily by

- pressing a desired smart key
- or
- by the desired channel activation that works as trigger.

4.6.3 SMART KEY COMMANDS ASSOCIATED WITH SMART KEY BUTTONS

In this point we study how to associate the previously created MACRO to one of the 8 **Smart Keys** (from **K1** to **K8**) buttons. Later we will also see how you can manage and use more than the only standard 8 ones.

Each **Smart Key** can control one or more remote software/devices in 2 different working modes

- OneButtonPressure (**IMPULSIVE**)
- by TwoButtonPressure (first pressure for **ON** and second pressure for **OFF**).

To access into the SMART KEYS CONFIG area go in:

OXYGEN REMOTER > SMART KEYS > SMART KEYS CONFIG > SMART KEYS

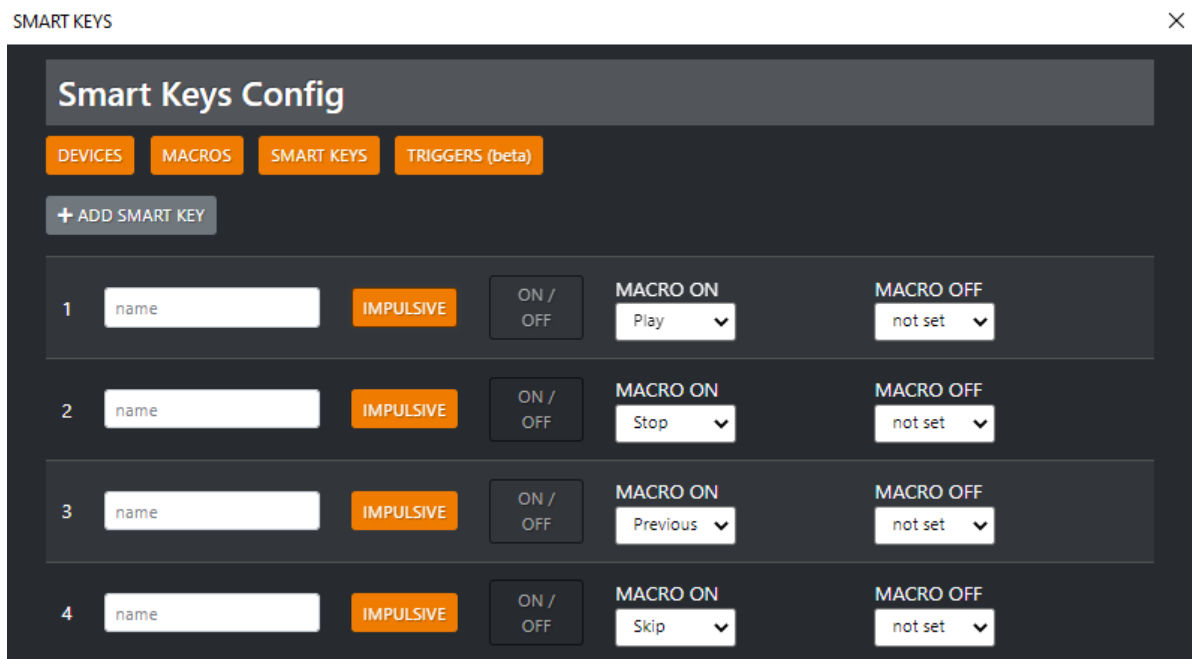

+ ADD SMART KEY: This button allows the user to set more Smart Keys than the standard 8 ones. The additional ones could be usable only by the remote console WEB PAGE in the subsection **SmartKeys > Live**.

Also reachable by the desired browser at the following URL address:

HTTP://"/CONSOLE_IP_ADDRESS"/HOME/SMARTKEYSLIVE

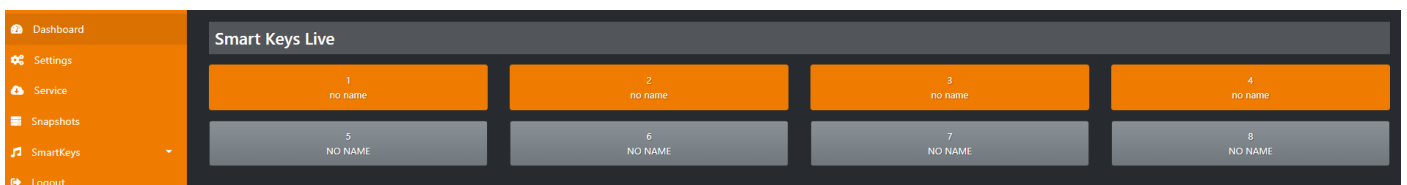

After the pressure of **+ ADD SMART KEY** you will see the previous section with the one added SMART KEY:

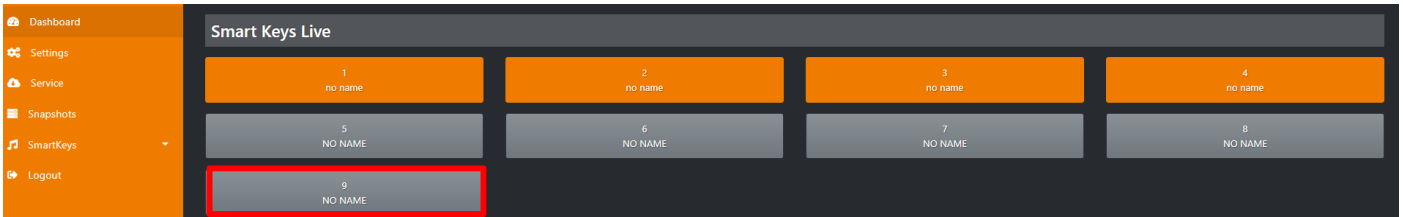

Orange SMART KEY buttons of the previous image were working and set, so you can also press them by here to send the command.

The grey ones are available but not set.

Each line of the SMART KEYS config sets one single Smart Key:

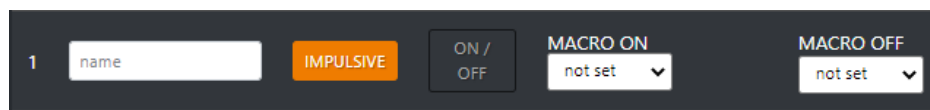

1 logical number of the button (K1 is 1, K2 is 2, K3 is 3 and so on)

by this field you can type a desired and customized name to your current Smart Key

in this example we have typed in the field **my K1 for start next**

The customized name will also be displayed only at the URL:

HTTP://"CONSOLE_IP_ADDRESS"/HOME/SMARTKEYSLIVE

as described by the following Web Page:

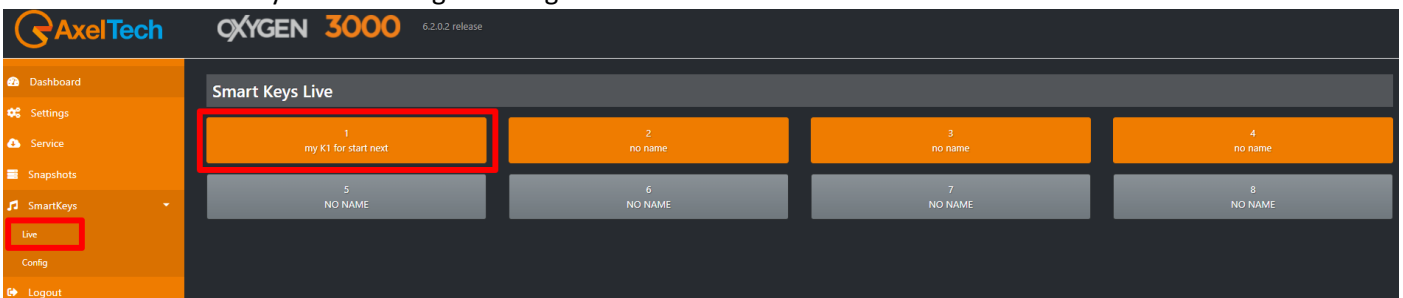

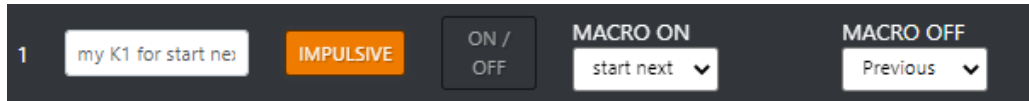

IMPULSIVE

By setting **IMPULSIVE** you associate only one MACRO to the current SMART KEY. If pressed, all the commands associated with the related MACRO will be sent to all of the set targets.

The only working MACRO will only be the one set in

The other one (**MACRO OFF**) will not be considered.

ON / OFF

By setting **ON / OFF** you associate 2 MACROs to the current SMART KEY. So the SMART KEY will work in 2 different states.

Smart Key 1st state will be **ON**: the will send all of its commands to all of their related targets.

Smart Key 2nd state will be **OFF**: the second MACRO (different by the previous one) will send all of its commads to all of their related targets.

If all the settings will be correctly done, you can use and press your SMART KEYS by the OXYGEN REMOTER

K1	K1	K5	K5
K2	K2	K6	K6
K3	K3	K7	K7
K4	K4	K8	K8

Or by the related web page [HTTP://\"CONSOLE_IP_ADDRESS\"/HOME/SMARTKEYSLIVE](http://\)

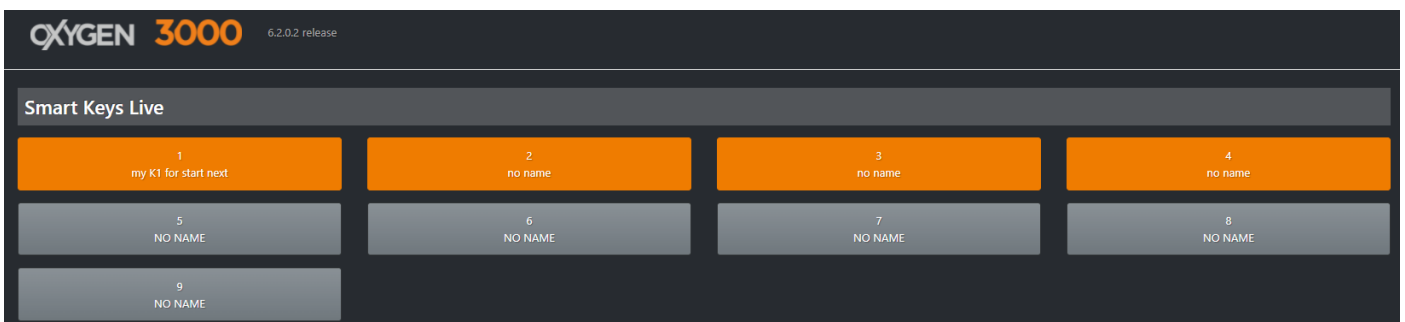

4.6.4 TRIGGER COMMANDS ASSOCIATED WITH CHANNEL SLIDER AND/OR ON/START BUTTON PRESSURE

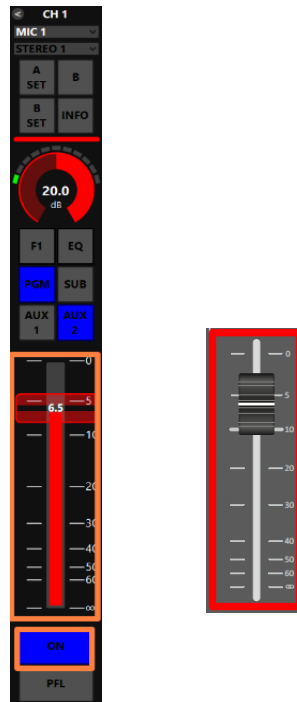



As you already know on each **Oxygen1000** or **OXYGEN2000** channel you can associate one **A SOURCE** and an alternative **B SOURCE**.

In example: CH1 could have the following 2 alternative audio sources:

A SOURCE = *MIC 1*
B SOURCE = *STEREO 1*

By associating the MACRO to the desired source, you will send commands to all of your Remote APPs / Devices (in example to your **Automation Software**)

- at the rise-up of the set slider and/or at the Oxygen Remoter ON/START=ON  pressure (**MACRO ON**)
- at the rise-down of the set slider and/or at the Oxygen Remoter ON/START=OFF  pressure (**MACRO OFF**).
- If **A SOURCE** is the current active source in the channel
 and if you have correctly defined a specific MACRO for A SOURCE (in this example **MIC 1**) the command will be successfully forwarded to the defined remote Application/Device.
- If **B SOURCE** is the current active source in the channel
 and if you have correctly defined a specific MACRO for B SOURCE (in this example **STEREO 1**) the command will be successfully forwarded to the defined remote Application/Device.

This kind of control could be assigned by

OXYGEN REMOTER > SMART KEYS > SET > TRIGGERS

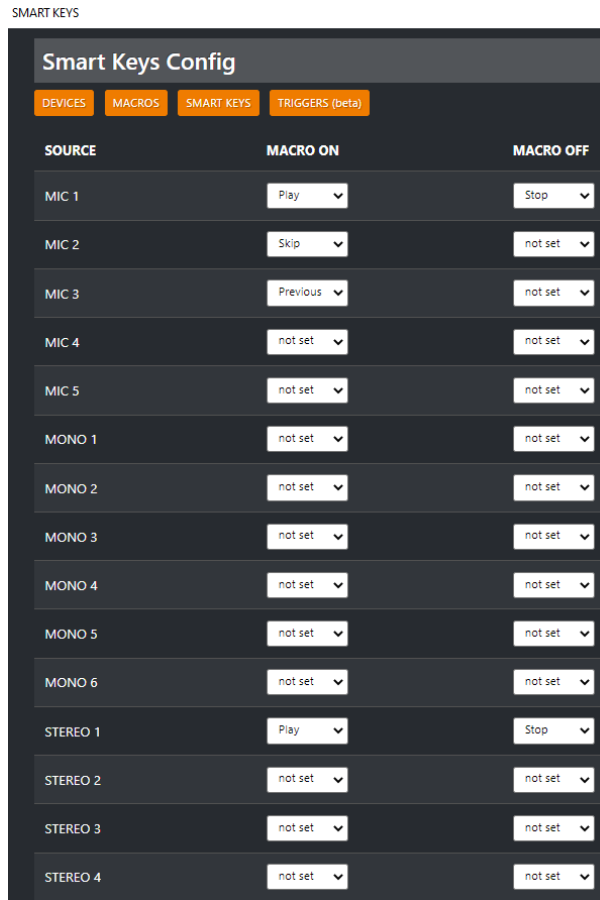

Every time you will start airing MIC 1 you will send all of the **Play** Macro commands. Every time you will stop airing MIC 1 you will send all of the **Stop** Macro commands.

The commands will be sent if you start/stop airing MIC1 either by the physical console or by OXYGEN REMOTER.

4.6.5 PC KEYBOARD SHORTCUTS ASSOCIATED TO THE SMART KEYS

Each defined Smart Key is associated to a precise Keyboard Shortcut by default.

If the Smart Key was not defined, the related Keyboard Shortcut will not work.

Below the relations between Smart Keys and related Keyboard Shortcuts:

SMART KEY	KEYBOARD SHORTCUT
K1	Ctrl+F1
K2	Ctrl+F2
K3	Ctrl+F3
K4	Ctrl+F4
K5	Ctrl+F5
K6	Ctrl+F6
K7	Ctrl+F7
K8	Ctrl+F8

4.11 SNAPSHOTS

Snapshot panel allows you to save 10 presets for CHANNELS, 10 presets for EQ and 10 presets for COMPRESSOR:

4.7.1 CHANNELS:

By this section you can easily save and load up to 10 presets.

Into each preset (1, 2, 3, 4, 5, 6, 7, 8, 9, 10) you can store all the current Channels (CH1, CH2, CH3...CH10) status related to **Audio Inputs (CHA and CHB) assignment, EQ and COMPRESSOR.**

These presets allow you to change very fastly from 10 different OXYGEN1000 or OXYGEN2000 intended use.

Everytime you need a totally different console configuration, these presets will avoid you to manually change the most important channel parameters one by one.

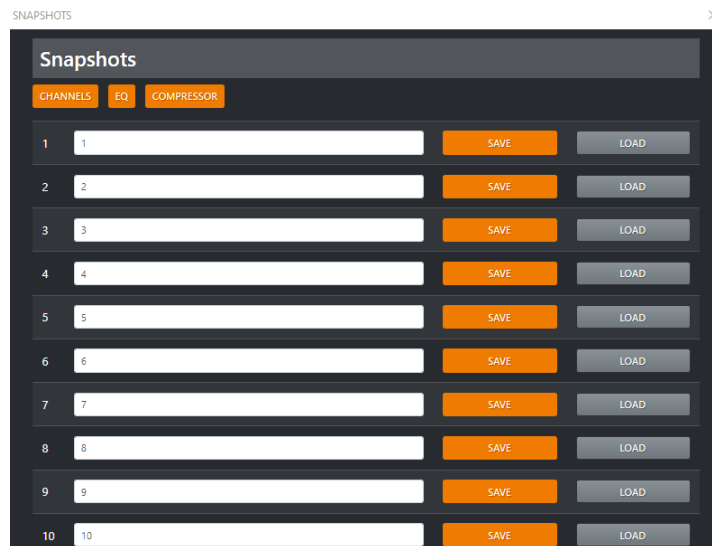

- Decide which preset you want to save or load (in example preset 1.)



- To Save a preset with all the channel assignment, EQ and Compressor: Press **SAVE** next to the desired **preset line** (in our example 1.) to store all the current Channels console **Audio Inputs (CHA and CHB) assignment, EQ and compressors** there.

The preset name is completely customizable:



- To Load a preset with all the channel assignment, EQ and Compressor: Press **LOAD** next to the desired **preset line** (in our example **1 Afternoon Program - Mark**) to apply this **previously saved preset to the console.**

4.7.2 EQ

By this section you can easily save and load up to 10 EQ presets. These 10 presets will be available and can be used on all the desired audio sources.

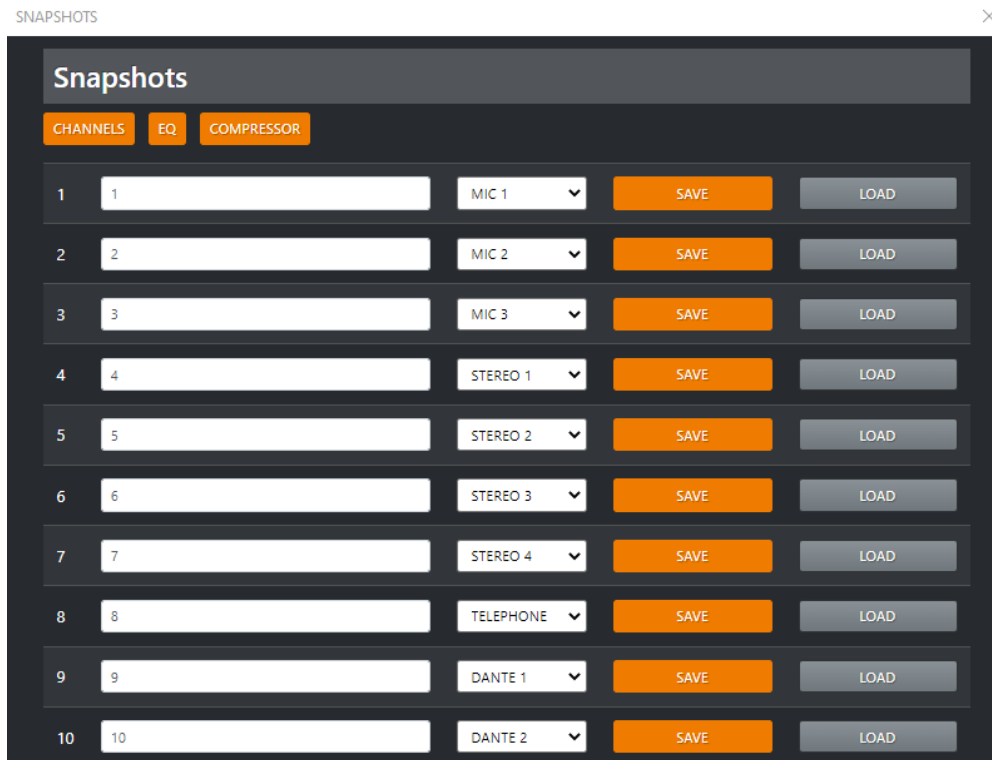

- Select an **Audio Source** (In example **STEREO 2**)

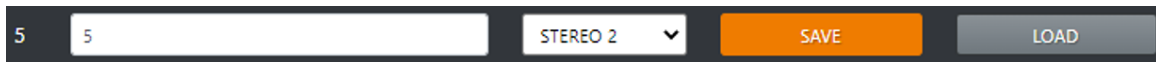

- Decide which **preset** you want to save or load (in example preset **5**).
 - To Save an EQ preset: Press **SAVE** next to the desired **preset line** (in our example **5**.) to store there the current **EQ Settings** of the selected **Audio Source** (in our example **STEREO 2**).

The EQ preset name is completely customizable:

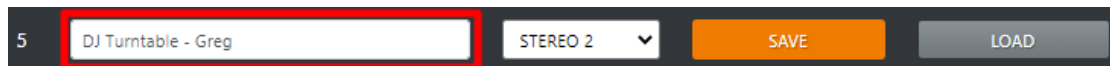

- To Load an EQ preset:

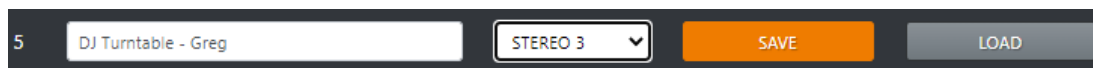

In the desired **preset line** (in our example **DJ Turntable - Greg**), select the Audio Source **STEREO 3** on which you want to load a desired EQ preset. Press **LOAD** to apply the preset **5 DJ Turntable - Greg** also to **STEREO 3**).

4.7.3 COMPRESSOR

By this section you can easily save and recall up to 10 COMPRESSOR presets. These 10 presets will be available and will be the same only for all the **MIC / MONO** audio sources. The compressor does not work for Stereo, Telephone, Digital lines.

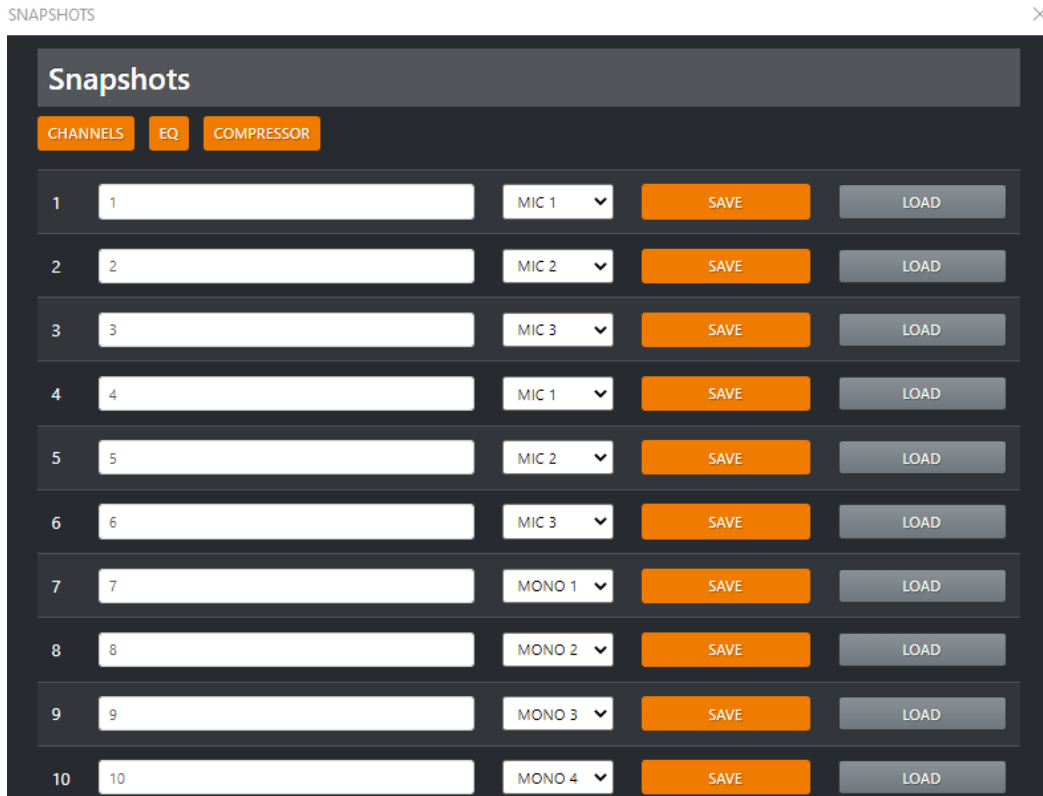

- Select an **Audio Source** (In example MIC3)
- Decide which **preset** you want to save or recall (in example preset 6.)

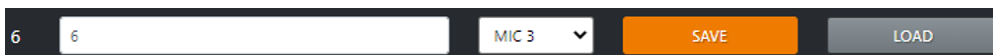

- To Save a compressor preset: Press **SAVE** next to the desired **preset line** (in our example 6.) to store there the current **COMPRESSOR Settings** of the selected **Audio Source** (in our example **MIC 3**).

The EQ preset name is completely customizable:

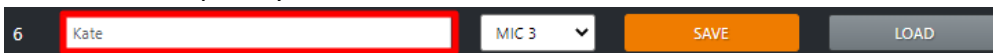

- To Load a compressor preset:

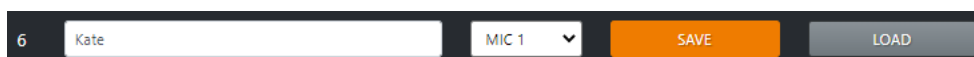

- Press **LOAD** next to the desired **preset line** (in our example 6.) to apply this **previously saved preset** to the selected **Audio Source** (in our example the preset 6. will be applied to **MIC 1**).

5 USB AUDIO 1 AND USB AUDIO 2 - AUDIO CARDS

Two USB audio interface

The USB audio interface allows to directly connect the PC to the **Oxygen** console, with no need for audio cards: in fact, the PC detects the console as a digital audio card with 2 stereo inputs and 2 stereo outputs for simultaneous playout and recording.

two Built-in stereos **USB I/O** Audio Interface to connect directly to a computer. USB Audio Card with a connector **Type-B**. With this type of connection, you can save hundreds of dollars on an audio card. By **OXYGEN** Digital Mixing Console, you can connect your computer or any digital device via perfect USB audio I/O sources.

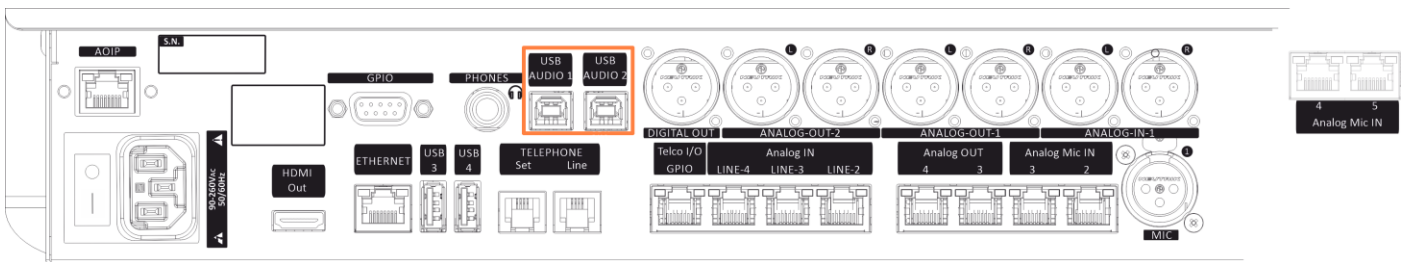

Once the mixer is connected to a computer, it will be recognized automatically and will not require any intervention. The connection is made via normal **USB-B cable 2.0**

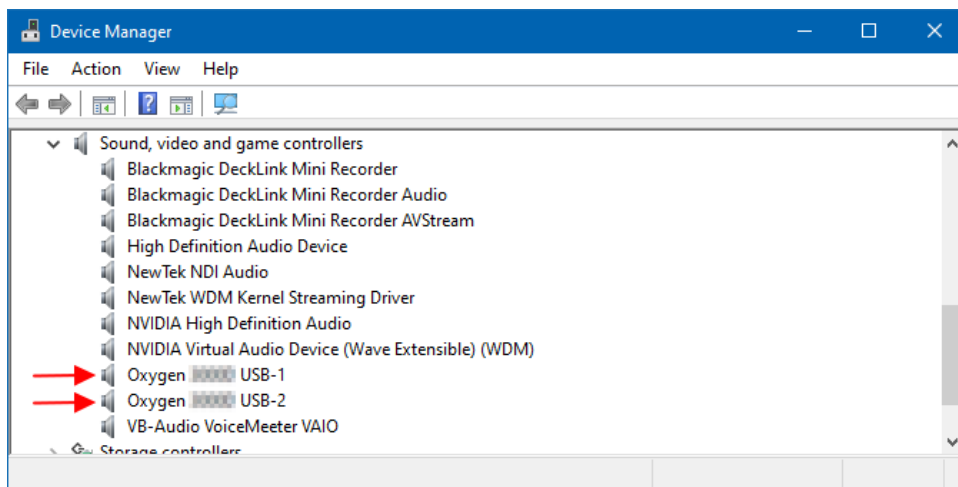

NOTE: Highly recommend that not use a (SS 10) SUPERSPEED USB port on the PC side.



To set the parameters correctly, we have to leave the **output/playback** as default (**48000 Hz**).
 For the **input/recording**, we have to change the frequency to (**44100 Hz**).

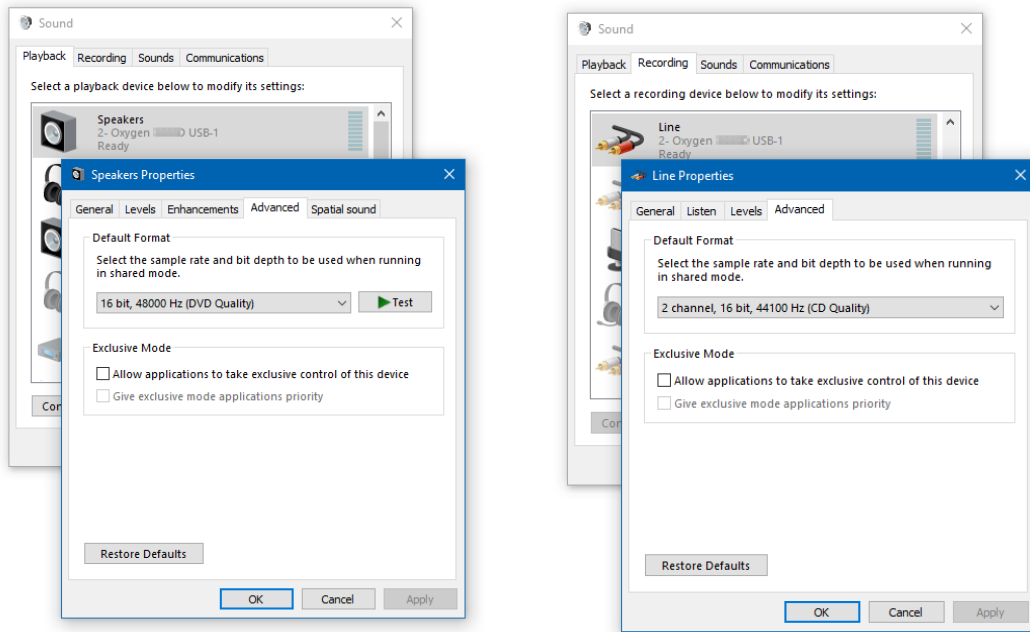

6 DANTE – IP AUDIO STREAMS

The first step of DANTE setting is to connect the DANTE port to the network.
 You can use a normal UTP (RJ-45) cable to connect the Network/Lan switch with the DANTE port shown in next figure. In this way your console will be automatically discovered all over your DANTE NETWORK.

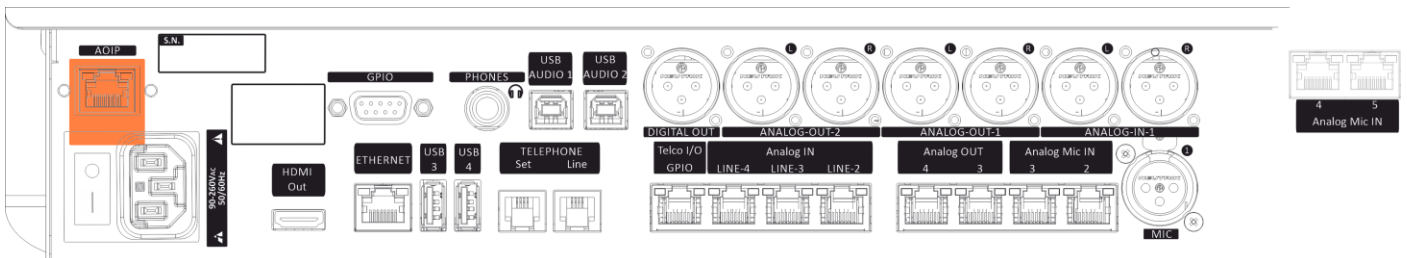

By this link you can read more information about DANTE CONTROLLER. In this web page you can also download the installer to monitor your DANTE NETWORK and to manage your audio routings:

[HTTPS://WWW.AUDINATE.COM/PRODUCTS/SOFTWARE/DANTE-CONTROLLER](https://www.audinate.com/products/software/dante-controller)

By official Audinate website is also possible to purchase for a proper Online Training on the DANTE technology:

[HTTPS://WWW.AUDINATE.COM/LEARNING/TRAINING-CERTIFICATION](https://www.audinate.com/learning/training-certification)

6.1 Viewing the Unit MAC Address

The MAC address of the unit is supplied by the Dante network. To view the MAC address, perform the following:

1. Open the installed Dante Controller
2. Dante Controller will give you a complete view of all Dante Devices into your DANTE NETWORK.
3. Look for the console device and double-click on its name into the left Dante Receivers list.

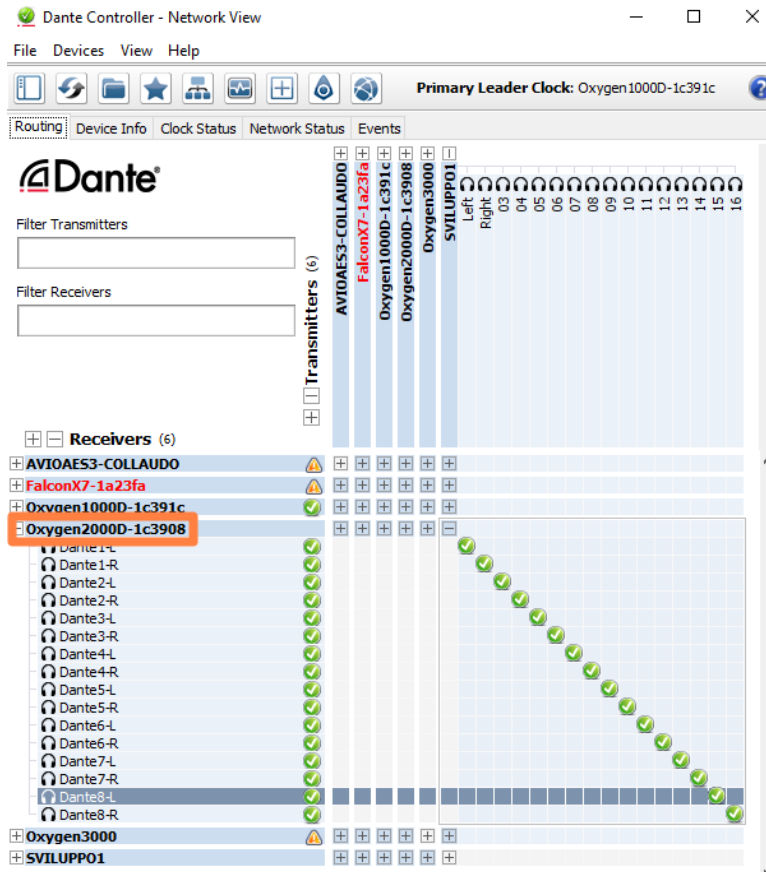

5. Select the Status tab.

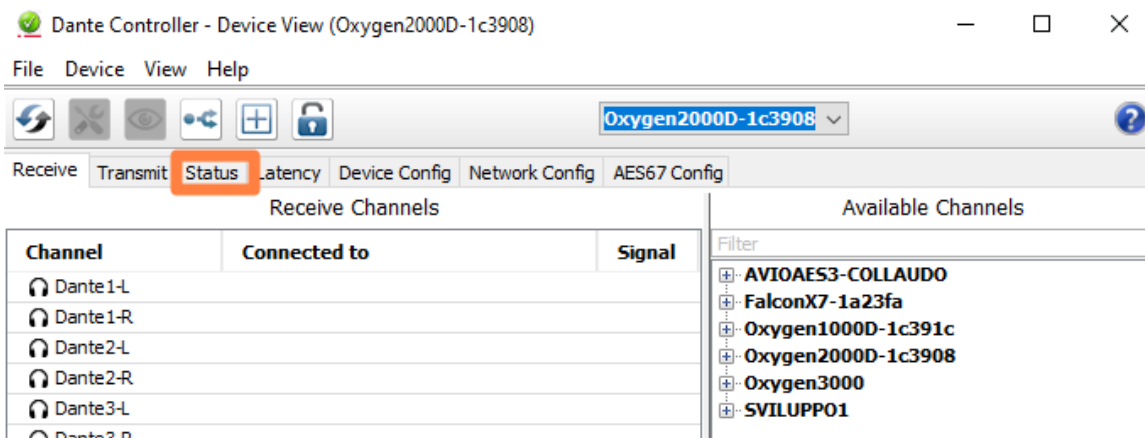

3. In Interfaces, view the MAC address.

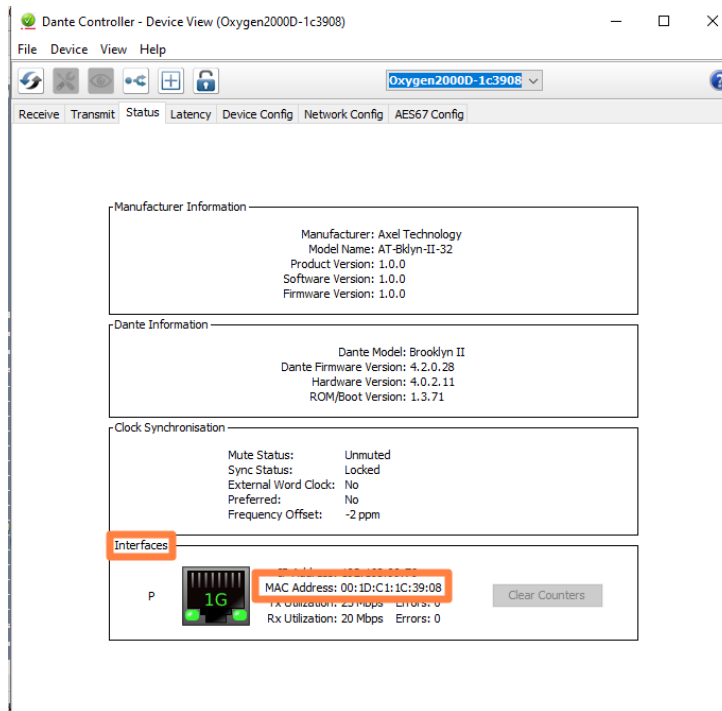

6.2 Network Config Tab

Always inside the previous window, open the Network Config Tab to toggle supported devices between Redundant and Switched modes, and to specify static IP addresses for a device's Ethernet ports.

Dante devices obtain IP addresses automatically by default, and in the vast majority of circumstances there is no need to change the Addresses settings. However, static IP addresses can be assigned if necessary.

To assign a static IP address:

1. Select 'manually configure an IP Address' for the appropriate Ethernet port.
2. Enter the IP Address and Netmask.
3. Click Apply.

The DNS Server and Gateway settings are optional - the device will use network defaults if they are not specified. Click Revert to revert back to the previous settings.

Note: Assigning static IP addresses requires a device reboot.

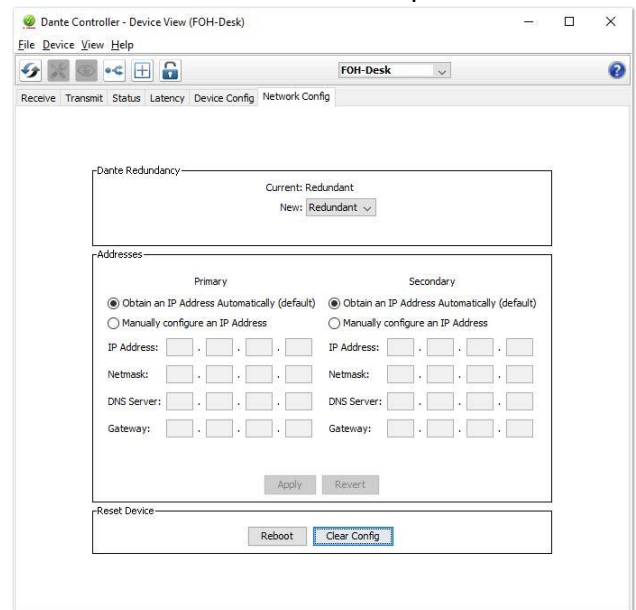

6.3 Incorrect IP address configuration

Dante network uses IP Addressing to communicate. Incorrect address configuration can make it hard or impossible for a Dante device to communicate. Dante Controller attempts to identify and report several types of incorrect IP address configuration, including:

- Having multiple DHCP servers on the same network.
- Incorrectly configured static IP addresses.
- Connecting the secondary interface of a Dante device to the primary network.
- Different interfaces on the same device using the same IP address subnet.
- Configuring a DHCP server on the primary network to use the IP address range reserved for secondary.
- link local devices (172.31.XXX.XXX).

For more information about Dante Controller, please go to:

<https://www.audinate.com/products/software/dante-controller>.

6.4 Dante Controller – Audio Routing Matrix

The following Routing tab of DANTE CONTROLLER, gives you a complete view of all of your DANTE Network devices. In your DANTE Network, this Routing section allows you to decide, by a unicast scheme (from a transmitter to a receiver), every single audio routing of all the available streams: which desired device transmits and which other device receives the transmitted stream.

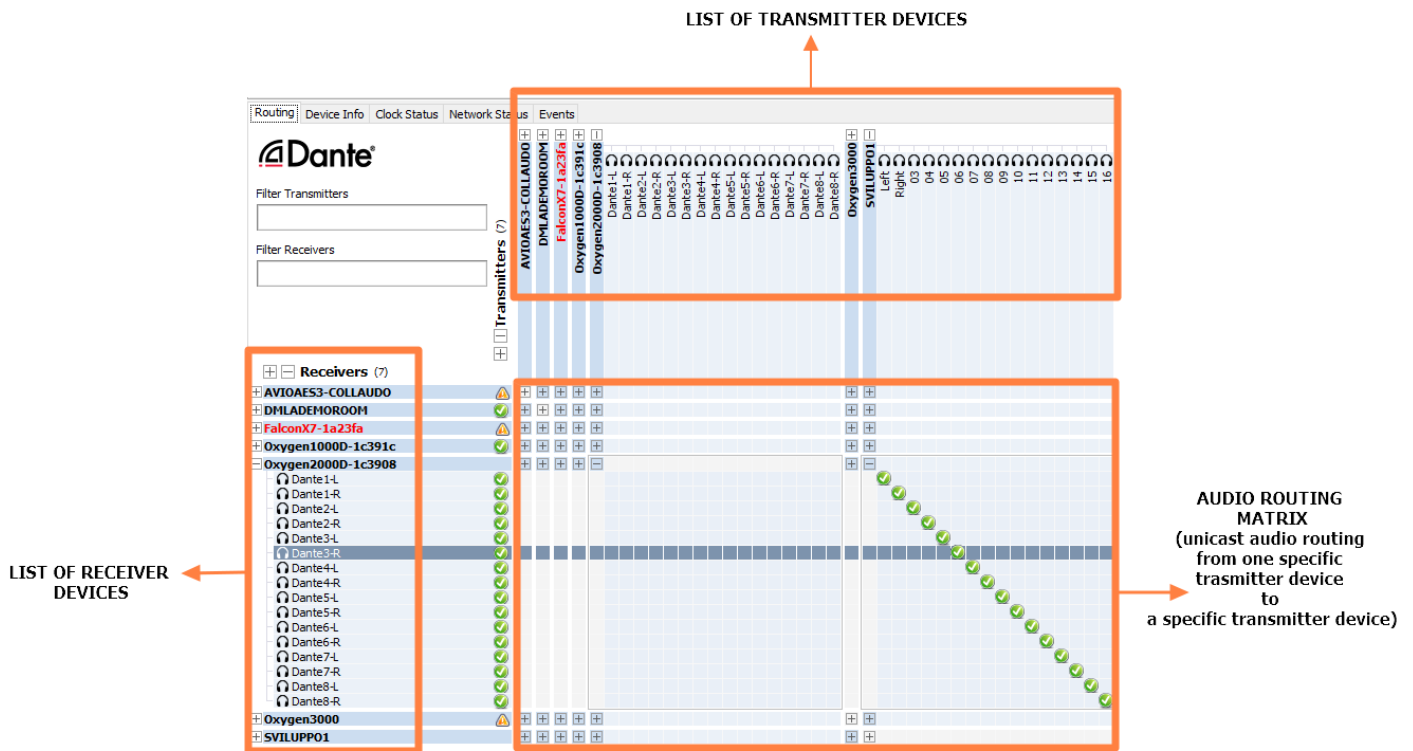

The underlying principle that guides the operation of this logic is the same as that which in the analog audio field allows the audio routing of an audio patch.

Dante Controller works as an audio patch that routes digital streams in a DANTE IP network.

The DANTE NETWORK consists of all those devices which have a specific DANTE network card inside them.

A device that does not have the Dante LAN card cannot be viewed in this Routing section.

PCs can become compatible within the environment of a DANTE NETWORK, by adding:

- By connecting to the same PC a special DANTE USB AVIO adapter

[HTTPS://WWW.AUDINATE.COM/PRODUCTS/DEVICES/DANTE-AVIO](https://www.audinate.com/products/devices/dante-avio)

or

- by installing in the same PC an audio driver called DANTE VIRTUAL SOUND CARD

[HTTPS://WWW.AUDINATE.COM/PRODUCTS/SOFTWARE/DANTE-VIRTUAL-SOUND CARD](https://www.audinate.com/products/software/dante-virtual-soundcard)

7 TELEPHONE LINES USAGE AND CONNECTIONS

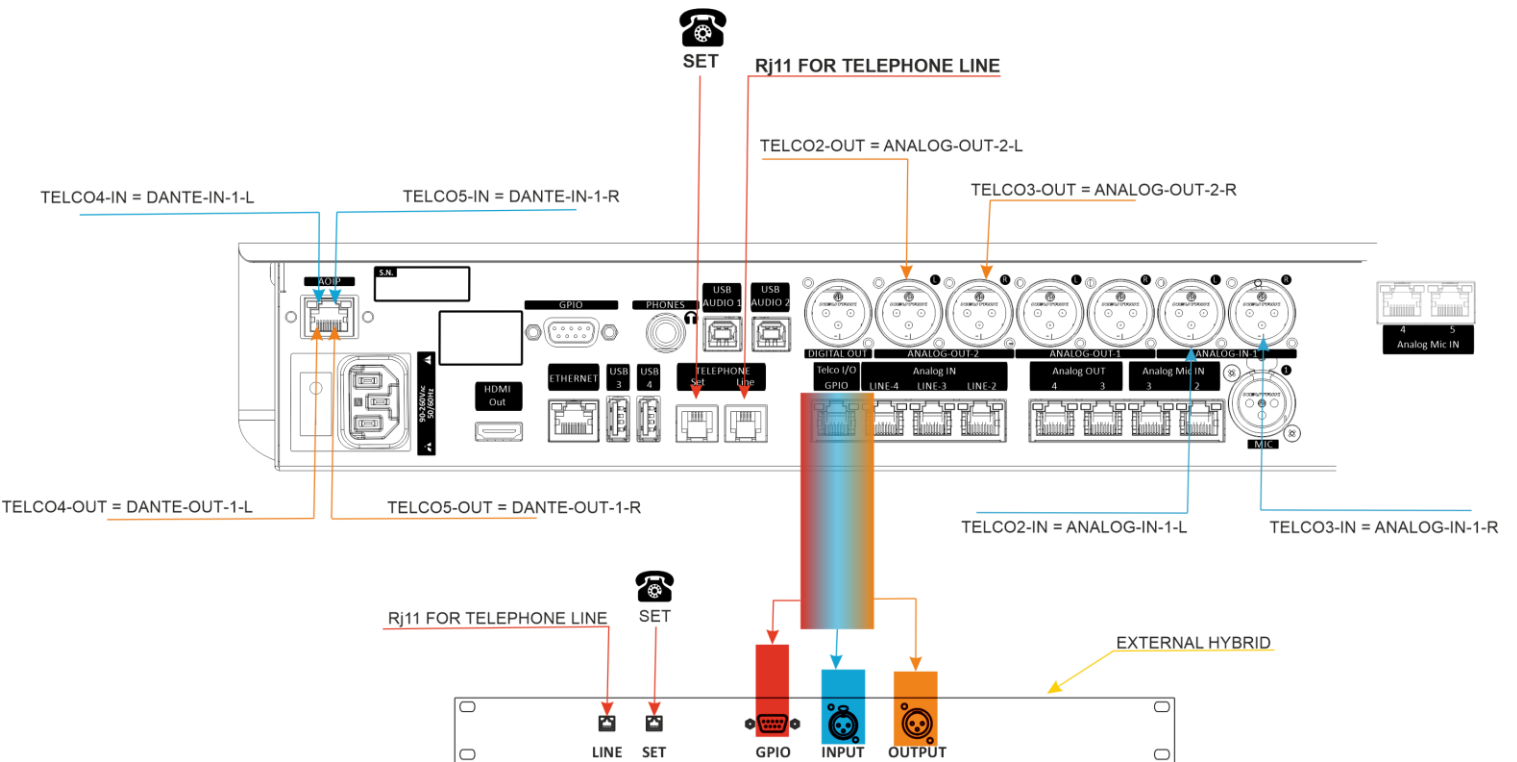

The console could manage 3 PHONE CALLS mode:

- INTEGRATED HYBRID LINE
- EXTERNAL TELCO DEVICE
- EXTERNAL BLUETOOTH DEVICE

7.3 INTEGRATED HYBRID LINE

You can directly connect a POTS/PSTN phone line to the OXYGEN back panel through the RJ11 connector called TELEPHONE LINE.

Before to send the phone-call on air it is also possible to manage the phonecall through the parallel POTS/PSTN phone device connected to the next SET port on the RJ11 connector.

The following parameter setting

MAIN / AUDIO / INPUTS / TEL/BT / TELEPHONE / GENERAL / F1 MODE = TELEPHONE

lets you assign the HOOK / DROP function to the related F1 button.

This parameter only affects the channel on which you have assigned the TELEPHONE source (so TELCO, BLUETOOTH will not be affected).

7.4 EXTERNAL TELCO DEVICE

A phonecall could be managed by an external TELCO DEVICE.

To use the device with the console you have only to connect one RJ45 connector to the related port labeled as TELCO I/O GPIO.

The correct cable pin-out is described in the +188 – OXY1000-OXY2000-RJ45-TELCO scheme. The cable appearance will be like the following one:

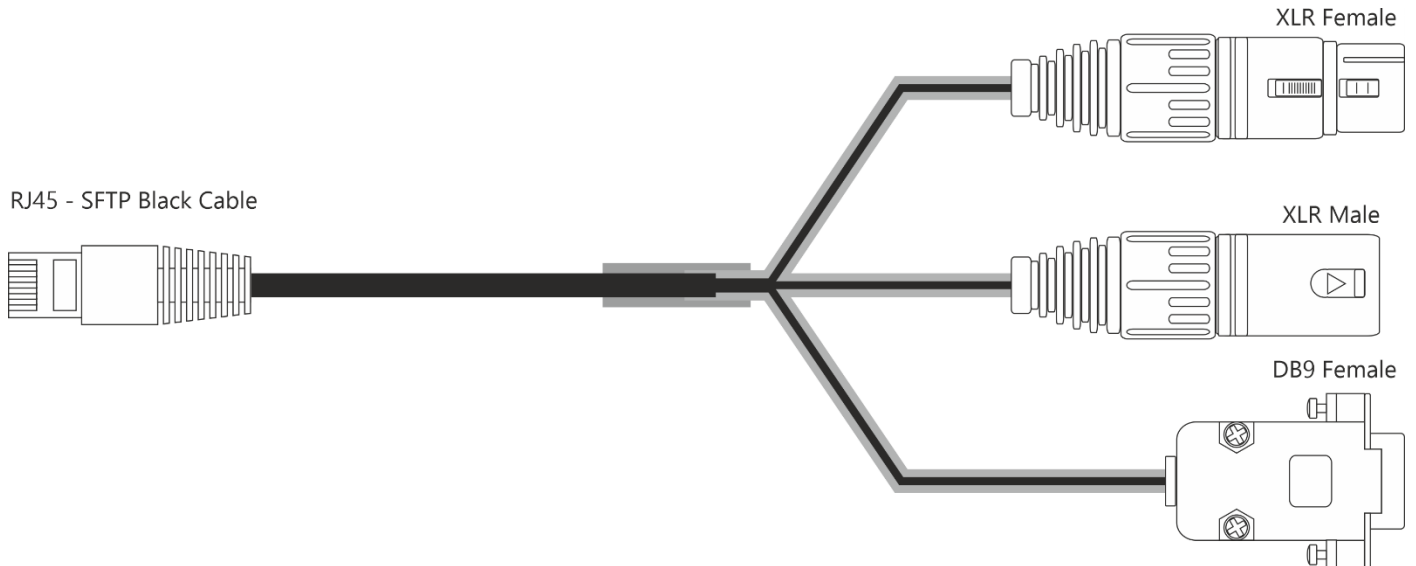

from this TELCO I / O GPIO port 4 different signals are carried: 2 audio-mono signals of the phone call itself and 2 general purpose electrical signals.

- mono telco INPUT signal
- mono telco OUTPUT signal (designed with the cleanfield / N-1 technology avoiding the INPUT signal return)
- GPI signal incoming from the external TELCO device. GPI signal forwards to the console the RING signal from the external device.
- GPO signal outgoing towards the external TELCO device. GPO signal forwards the HOOK command to the external device.

Set

MAIN / AUDIO / INPUTS / TEL/BT / TELCO 1 / GENERAL / F1 MODE = TELEPHONE

to assign the HOOK / DROP function to the related F1 button.

This parameter only affect the channel on which you have assigned the TELCO 1 source (not TELEPHONE, BLUETOOTH, TELCO 2, TELCO 3, TELCO 4).

7.4.1 TELCO 1 GPIO SETTINGS

The GPIO settings for this primary TELCO device are settable by this OXYGEN REMOTER sub menu

MAIN / GENERAL / GPIO

To manage TELCO 1 GPI signal set the TELCO 1 RING by the following submenu:

MAIN / GENERAL / GPIO / GPI / TELCO 1

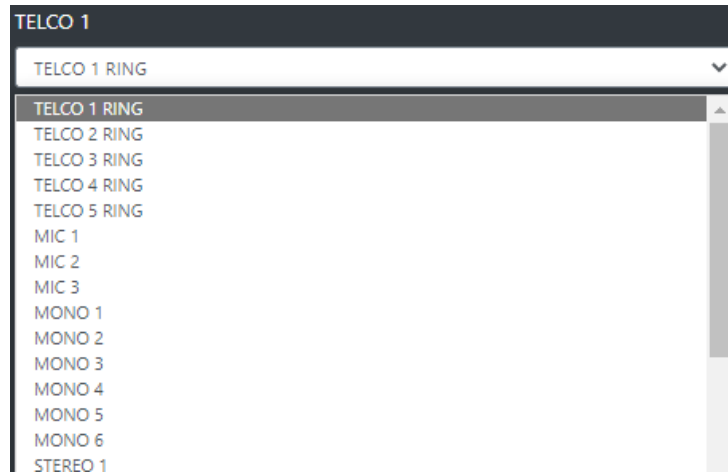

To manage TELCO 1 GPO signal set the TELCO 1 HOOK by the following submenu:

MAIN / GENERAL / GPIO / GPO / TELCO 1

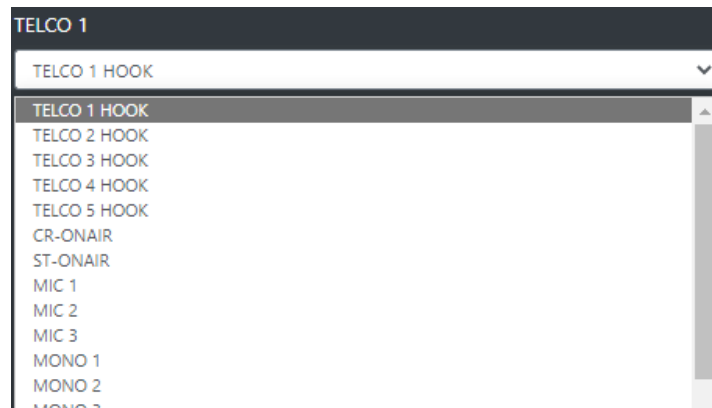

7.4.2 ADDITIONAL TELCO LINES

It is possible to use 4 more additional TELCO lines (TELCO 2 / TELCO 3 / TELCO 4 / TELCO 5) by setting the console with the correct parameters.

The following F1 MODE parameter could be set individually for each additional TELCO, in this example we are showing you the correct setting for TELCO 2:

MAIN / AUDIO / INPUTS / TEL/BT / TELCO 2 / GENERAL / F1 MODE = TELEPHONE

to assign the HOOK / DROP function to the related F1 button.

This parameter only affects the channel on which you have assigned the TELCO 2 source (not TELEPHONE, BLUETOOTH, TELCO 1, TELCO 3, TELCO 4).

The same F1 setting could be found into each TELCO input and will not affect the other TELCOs.

7.4.2.1 ADDITIONAL TELCO INPUT LINES

ANALOG-IN-1 could be configured as 2 different mono TELCO inputs:

TELCO 2: ANALOG-IN-1-L

TELCO 3: ANALOG-IN-1-R

to use the 2 above signals as 2 separate telco input lines please set the related parameter as follow:

MAIN/AUDIO/SETTINGS/INPUT MODE/LINE 1 MODE = 2 TELCO

after this setting the choosable source will be no more only ANALOG-IN-1 but the 2 input signals will be labeled in the source list as TELCO 2 and TELCO 3.

DANTE-IN-1 could be configured as 2 different TELCO mono inputs:

TELCO 4: DANTE-IN-1-L

TELCO 5: DANTE-IN-1-R

***NB:** If your console does not have the DANTE option you can not have TELCO 4 and TELCO 5. The only available additional TELCO will be TELCO 2 and TELCO 3.*

to use the 2 above signals as 2 separate telco input lines please set the related parameter as follow:

MAIN/AUDIO/SETTINGS/INPUT MODE/DANTE 1 MODE = 2 TELCO

7.4.2.2 ADDITIONAL TELCO OUTPUT LINES (CLIENFIELD / N-1 LOGIC)

OUT-2 (ANALOG-OUT-2) source could be configured as 2 different TELCO mono outputs:

TELCO 2: ANALOG-OUT-2-L

TELCO 3: ANALOG-OUT-2-R

to use the 2 above signals as 2 separate telco output lines please set the related parameter as follow:

MAIN/AUDIO/OUTPUTS/ANALOG/OUT-2/ source = N-1 T2/T3

- TELCO 2 caller can also listen TELCO 3 caller
- TELCO 3 caller can also listen TELCO 2 caller

or

MAIN/AUDIO/OUTPUTS/ANALOG/OUT-3/ source = N-1 T2+T3

- TELCO 2 caller can not listen for TELCO 3 caller
- TELCO 3 caller can not listen for TELCO 2 caller

DANTE-OUT-1 could be configured as 2 different TELCO mono outputs:

- TELCO 4: DANTE-OUT-1-L

- TELCO 5: DANTE-OUT-1-R

to use the 2 above signals as 2 separate telco output lines please set the related parameter as follow:

MAIN/AUDIO/OUTPUTS/DIGITAL/DANTE-1/ source = N-1 T4/T5

- TELCO 4 caller can also listen TELCO 5 caller
- TELCO 5 caller can also listen TELCO 4 caller

or

MAIN/AUDIO/OUTPUTS/DIGITAL/DANTE-1/ source = N-1 T4+T5

- TELCO 4 caller can not listen for TELCO 5 caller
- TELCO 5 caller can not listen for TELCO 4 caller.

7.4.2.3 USABLE GPIO FOR THE ADDITIONAL TELCO LINES

If the GPIO port is not already used, it is possible to implement a GPIO communication with all of the additional external TELCO devices by using the GPIO port.

The SUB-D9 pin-out is described into the GPIO PINOUT scheme, resumed by the picture below:

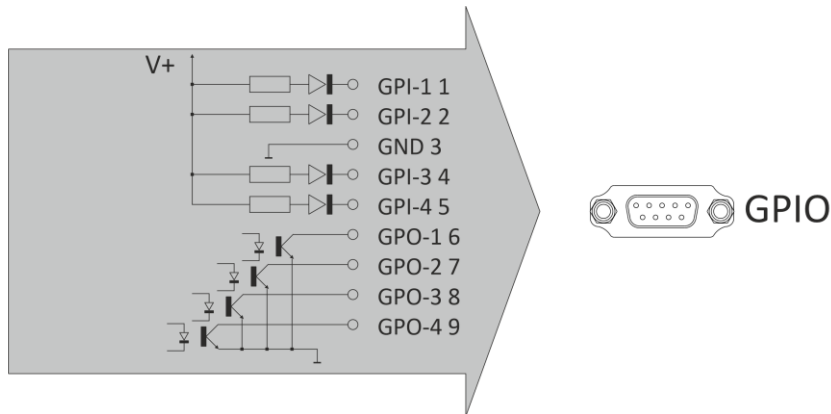

In this previous scheme is described the pinout of this SUB D9 connector.

Each GPI and each GPO is manageable by the OXYGEN REMOTER menu SETUP > GENERAL > GPIO.

The involved GPIs are:

- GPI-1**
- GPI-2**
- GPI-3**
- GPI-4**

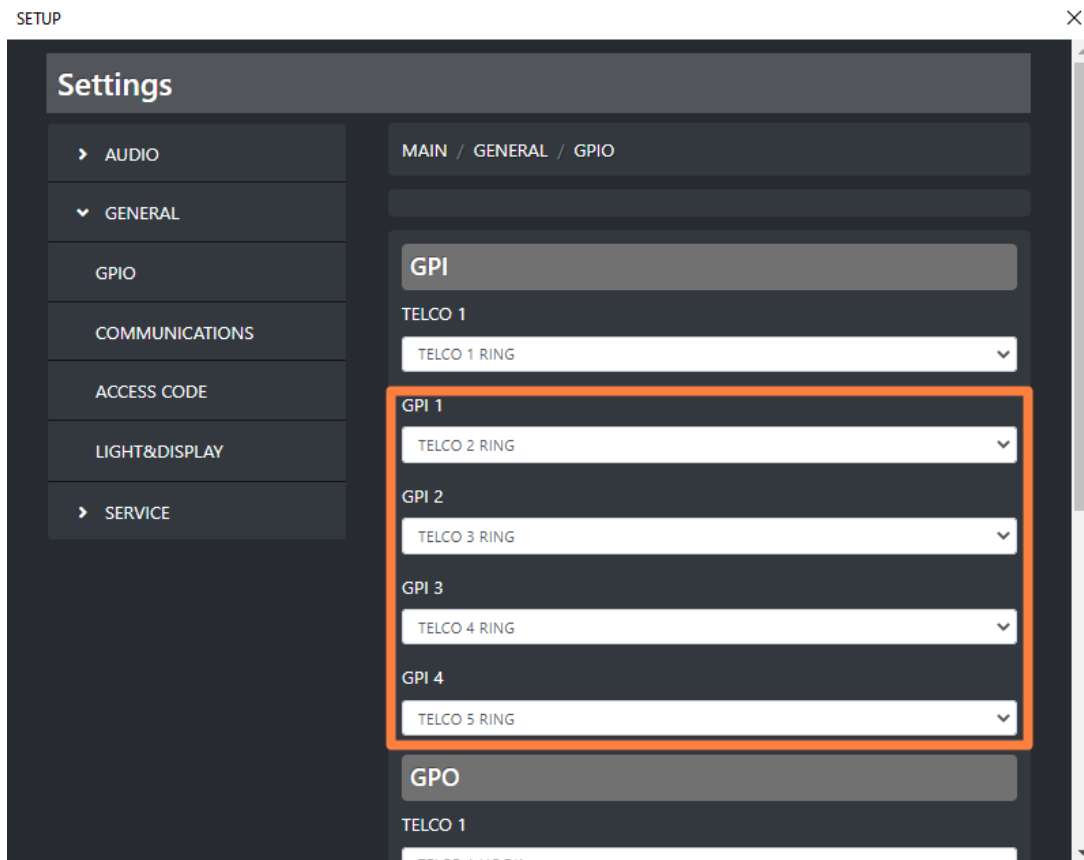

The involved options are:

- TELCO 2 RING**
- TELCO 3 RING**
- TELCO 4 RING**
- TELCO 5 RING**

The involved GPOs are:

- GPO-1**
- GPO-2**
- GPO-3**
- GPO-4**

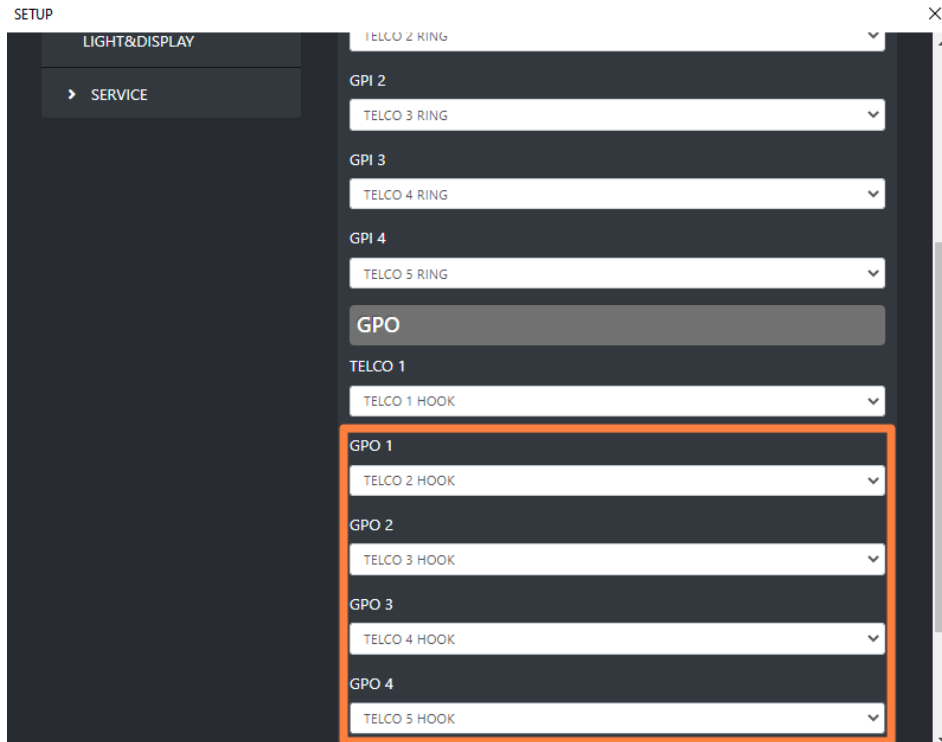

The involved options are

- TELCO 2 HOOK**
- TELCO 3 HOOK**
- TELCO 4 HOOK**
- TELCO 5 HOOK**

7.5 EXTERNAL BLUETOOTH DEVICE

The console allows you to pair an external bluetooth device for the following 2 excluding purposes:

- Microphone **TX**(Mono)- **RX**(Mono) Interface for telephone communication (GSM call, Skype, FaceTime, WhatsApp, Facebook, Etc.)
- **RX** (Stereo) interface for file/streaming player...

The device is in pairing mode after a fast press (< 1 sec) of the Bluetooth button. It starts to blink in blue color.



search for the **Oxygen 1000D-XXXX** if you have an Oxygen 1000 (or search for the **Oxygen 2000D-XXXX** if you have an Oxygen 2000) in Bluetooth device and connect with it. Once the device is connected the blue light stops blinking.



From OXYGEN REMOTER assign the Bluetooth audio source by selecting it into the desired drop-down menu (for example in 4th channel CH-A)



Press the desired BUS on the channel (in example PGM).



start the audio streaming (music, audio from YouTube/Music Player) or the phone call (Call, Skype, WhatsApp,) from the Bluetooth device.



With a long press of the Bluetooth button , you will disconnect the device.

If you turn on again the Bluetooth in the device and if the device is still associated with the console, it will be automatically paired. You will see a fixed blue light. The console is included **RN52 Bluetooth Audio Module**.

Note: For the module certifications, check this website please:

[HTTPS://WWW.MICROCHIP.COM/WWWPRODUCTS/EN/RN52](https://www.microchip.com/wwwproducts/en/rn52)

The F1 button for the channel in which you have assigned the BLUETOOTH source works differently from the other TELEPHONE sources (intenal TELEPHONE and external TELCOs).

The HOOK/DROP function has to be done by the external mobile device.

By F1 you only allow the audio signal forwarding to the same console channel.

8 ADDITIONAL VIRTUAL CHANNELS

ADDITIONAL VIRTUAL CHANNELS allow you to add up to 8 virtual channels to your existing physical channels of the OXYGEN console.

To do that you have to set the **ENABLE VIRTUAL CHANNELS** parameter as follow:

MAIN / AUDIO / SETTINGS / ENABLE VIRTUAL CHANNELS = ON

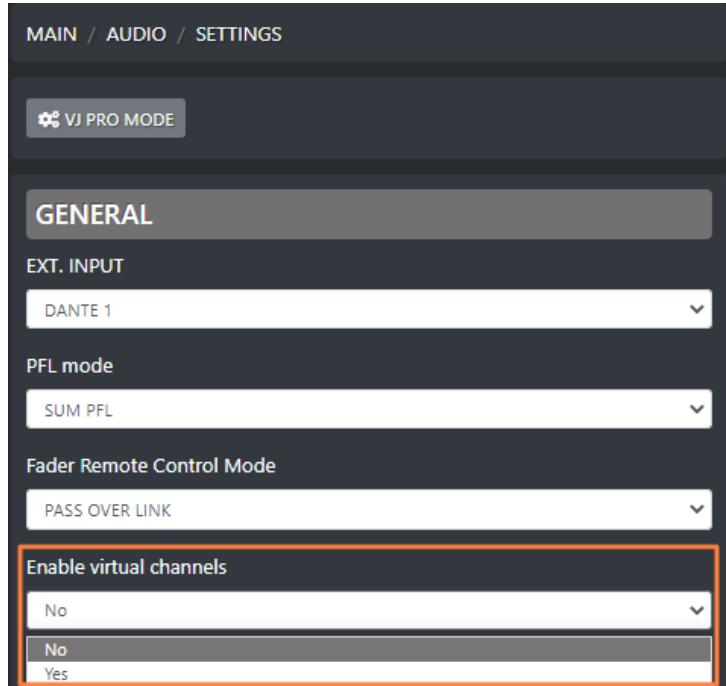

After the previous parameter was correctly set, you will see a **+** button appearing at the right of your last Oxygen Remoter channel as described below:



By pressing it you will add one Virtual channel manageable by OXYGEN REMOTER and not manageable by the console surface:

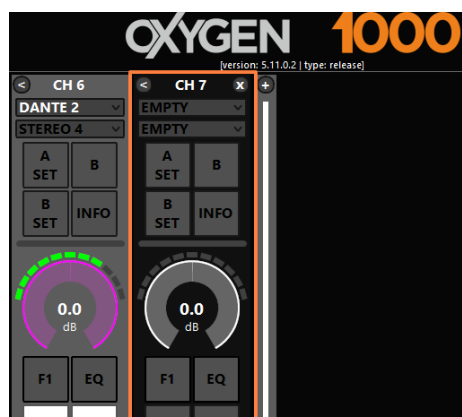

The Virtual Channels settings and workflow are exactly the same of the other ones.

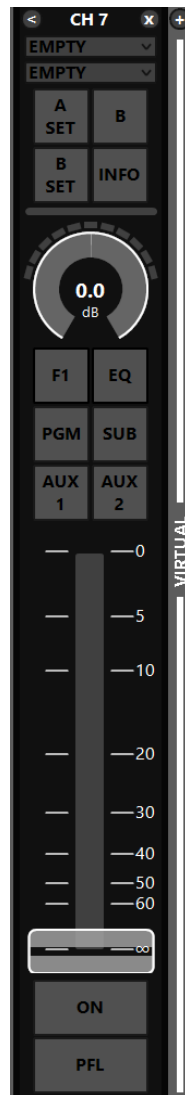

9 HDMI OUTPUT

By connecting an HDMI screen to the console's HDMI port, it is possible to have a general view of the current general status of the mixer in real time in a compact and beautifully designed display.

9.3 HDMI OUTPUT – NORMAL MODE

The HDMI screen has to be connected to the console before the console startup.

The following picture is the HDMI OUTPUT – Normal Mode:

1. Channel numbers.
ON/OFF channel STATUS.
Source names associated with channels.
Audio Led Meters of the channels.
The added virtual channels too will be visible.
2. Label showing the current activation of the VIRTUAL CHANNELS ON function &
Display label of the current presence of remote clients via OXYGEN REMOTER
3. OXYGEN model
4. Firmware release and console IP Address.
5. STUDIO mics and CONTROL ROOM mics timers.
NTP synchronized Date/Time.
6. Customizable - Station Logo
7. general Snapshot currently loaded
8. ONAIR MIC status
9. GPIO status
10. Speakers and Headphones status.
11. PFL / PGM / SUB / AUX1 / AUX2 output ledmeters



However, it is possible to choose between the available display layouts from the menu:

MAIN / GENERAL / LIGHT&DISPLAY / DISPLAY

It is possible to choose a provided TEST PAGE to help you in the first HDMI screen connection.

9.4 HDMI MENU NAVIGATION – SPECIAL MODE

Oxygen 1000 & Oxygen 2000 let you navigate through the setting menus also by the external plugged HDMI screen.

The HDMI screen has to be connected to the console before the console startup.

9.2.1 HDMI MENU NAVIGATION - ACTIVATION

The HDMI menu navigation has to be activated as a console SPECIAL MODE, by pressing the following 4 last right knobs simultaneously.

OXYGEN 1000 – HDMI MENU NAVIGATION – ACTIVATION



Simultaneous pressure of the GAIN knobs on the OXYGEN 1000 to activate the HDMI MENU NAVIGATION:

- CHANNEL-3 GAIN - pressure
- CHANNEL-4 GAIN - pressure
- CHANNEL-5 GAIN - pressure
- CHANNEL-6 GAIN - pressure

OXYGEN 2000 – HDMI MENU NAVIGATION – ACTIVATION



Simultaneous pressure of the GAIN knobs on the OXYGEN 2000 to activate the HDMI MENU NAVIGATION:

- CHANNEL-9 GAIN - pressure
- CHANNEL-10 GAIN - pressure
- CHANNEL-11 GAIN - pressure
- CHANNEL-12 GAIN - pressure

9.2.2 BROWSING CONTROLS FOR THE HDMI MENU NAVIGATION

After the special mode was successfully activated,

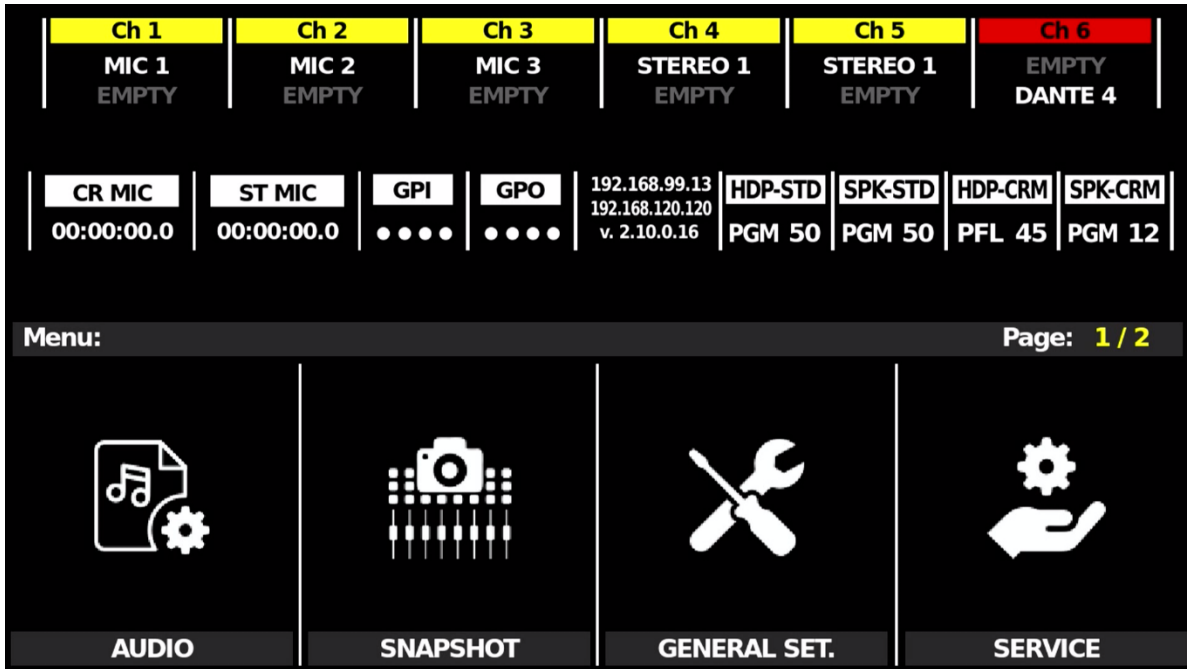

you will be able to move into all of your console menu pages and subsections by the same previously specified GAIN KNOBS and the related F1 BUTTONS as described by the following 2 pictures:

GENERAL NAVIGATION BUTTONS

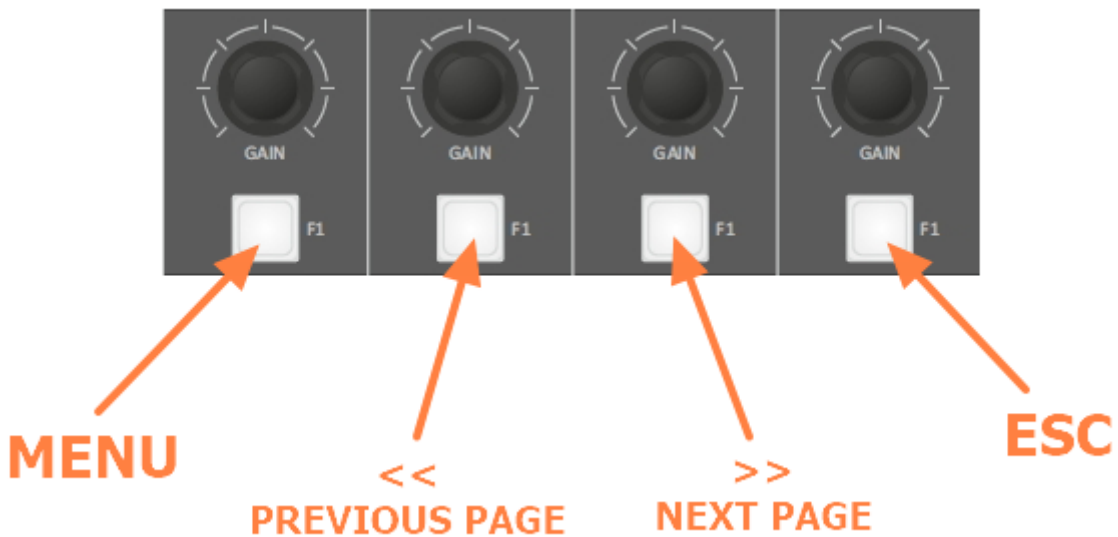

Some menu needs more than a page to show you all the settable parameters.

By

- << PREVIOUS PAGE
- NEXT PAGE >>

It will be possible for you to skip to the desired page. (From the picture below you can see the current page index: you are currently at page 1 of the 2 available):

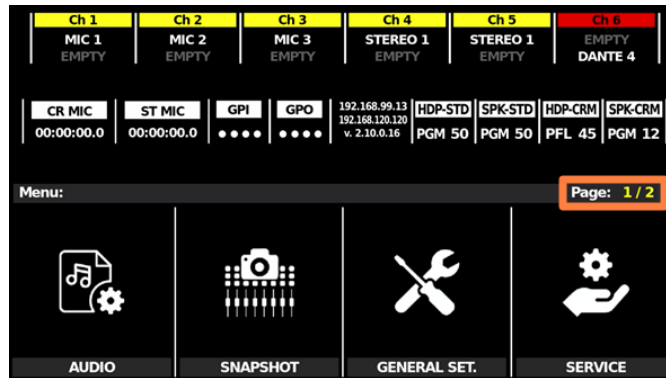

NB: the repeated pressure of the ESC button will take you again on the HDMI OUTPUT – Normal Mode

SINGLE PARAMETER SETTING

Push to confirm the value

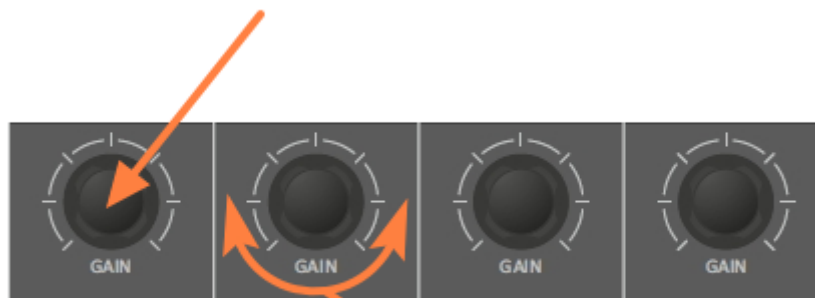

Rotate to modify the value

In the following picture the relation between HDMI MENU NAVIGATION sections and above KNOBS:

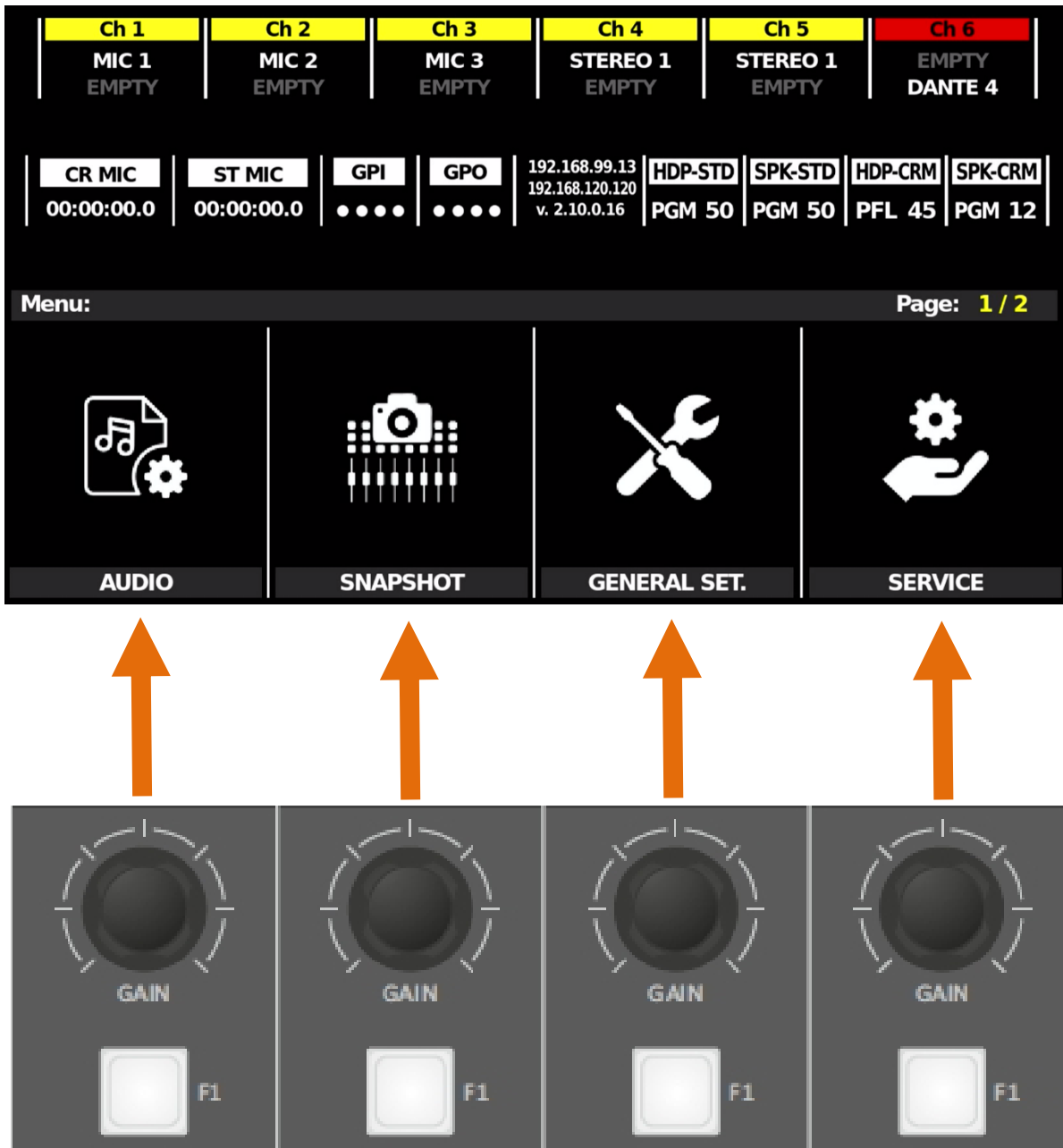

10 SUBD9-GPIO

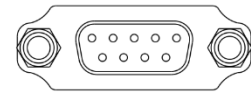
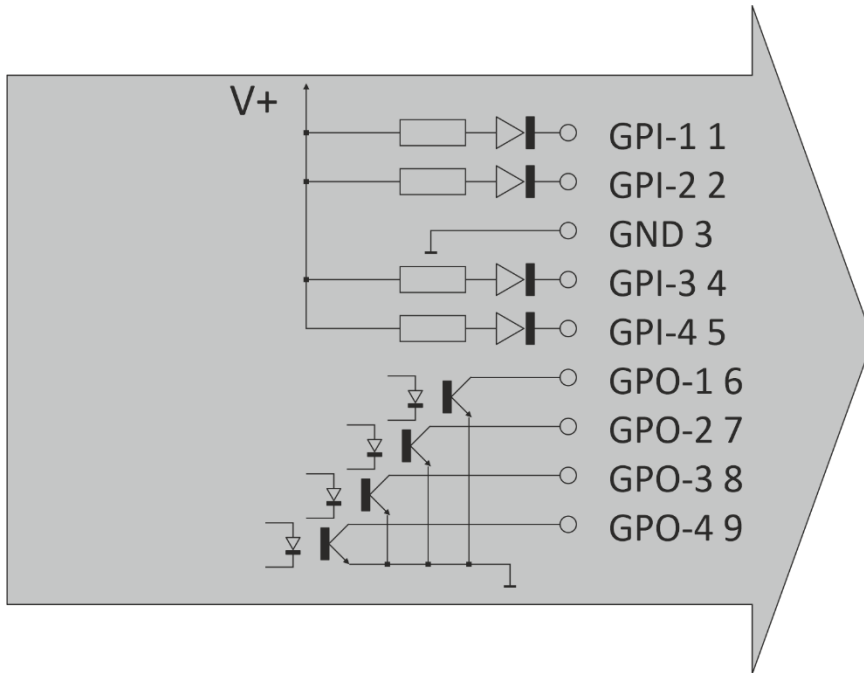

GPIO

11 + 187 – OXY1000-OXY2000-RJ45-MIC

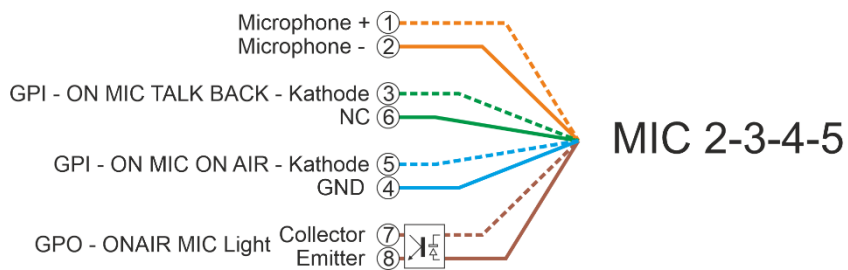
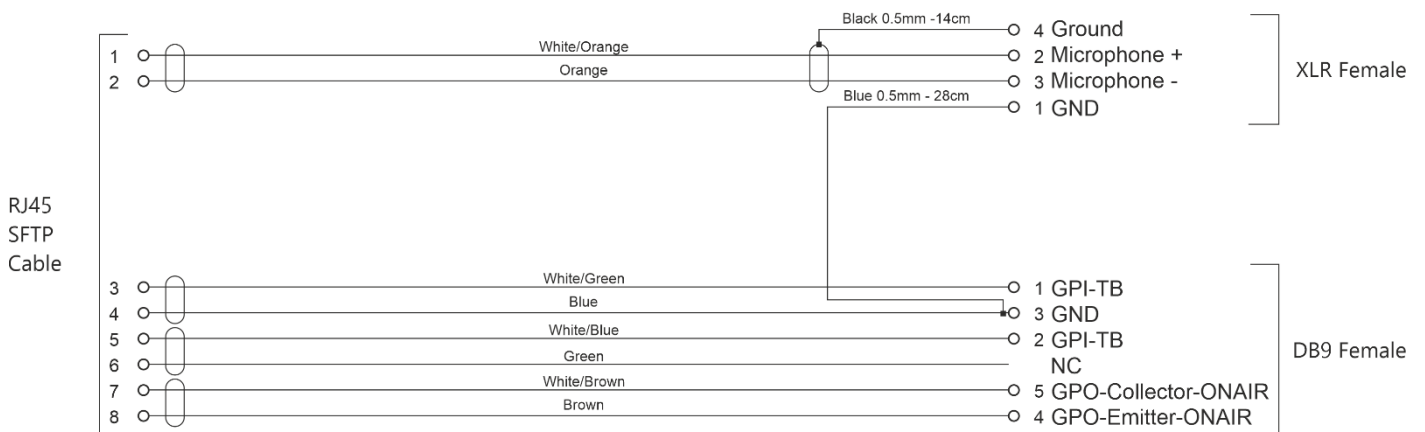
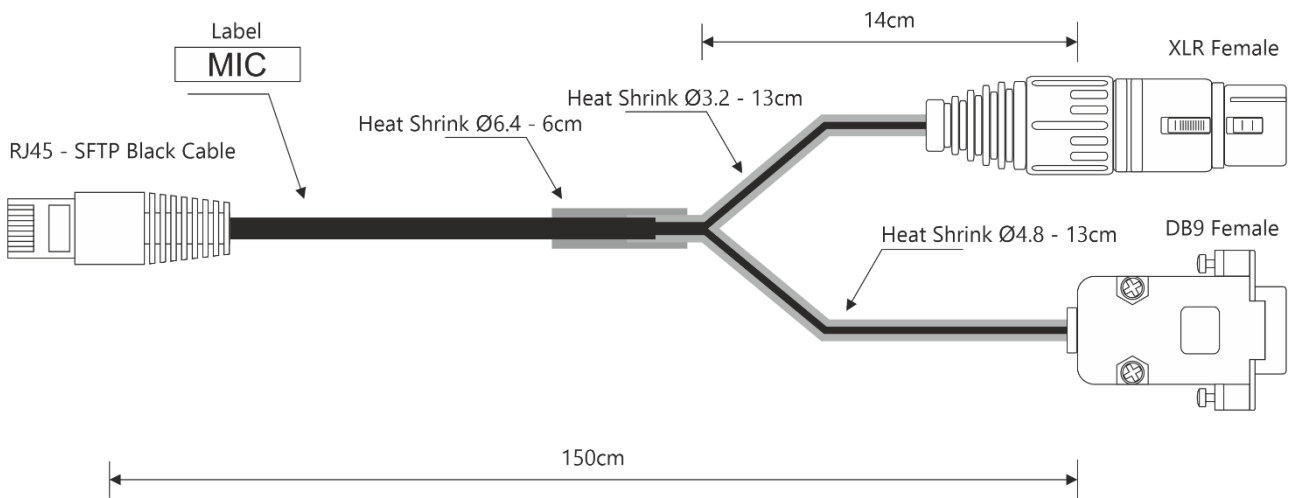

12 + 188 – OXY1000-OXY2000-RJ45-TELCO

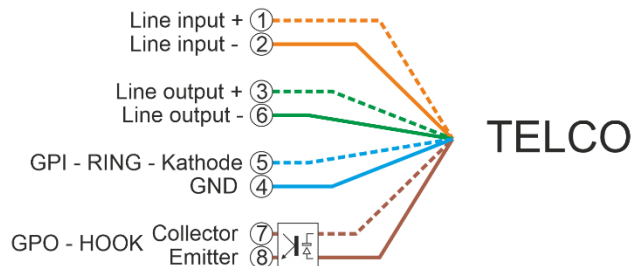
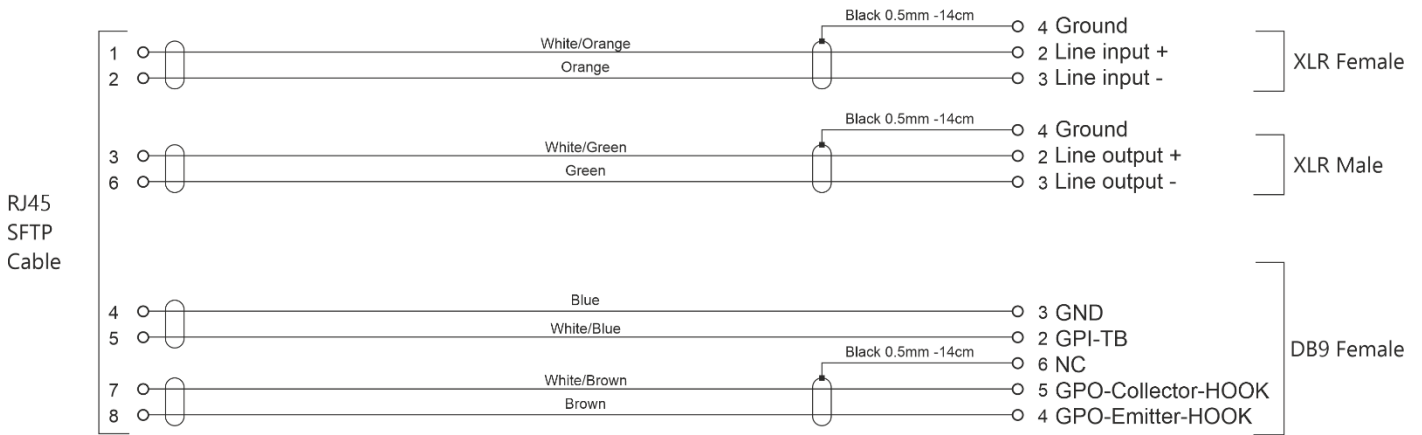
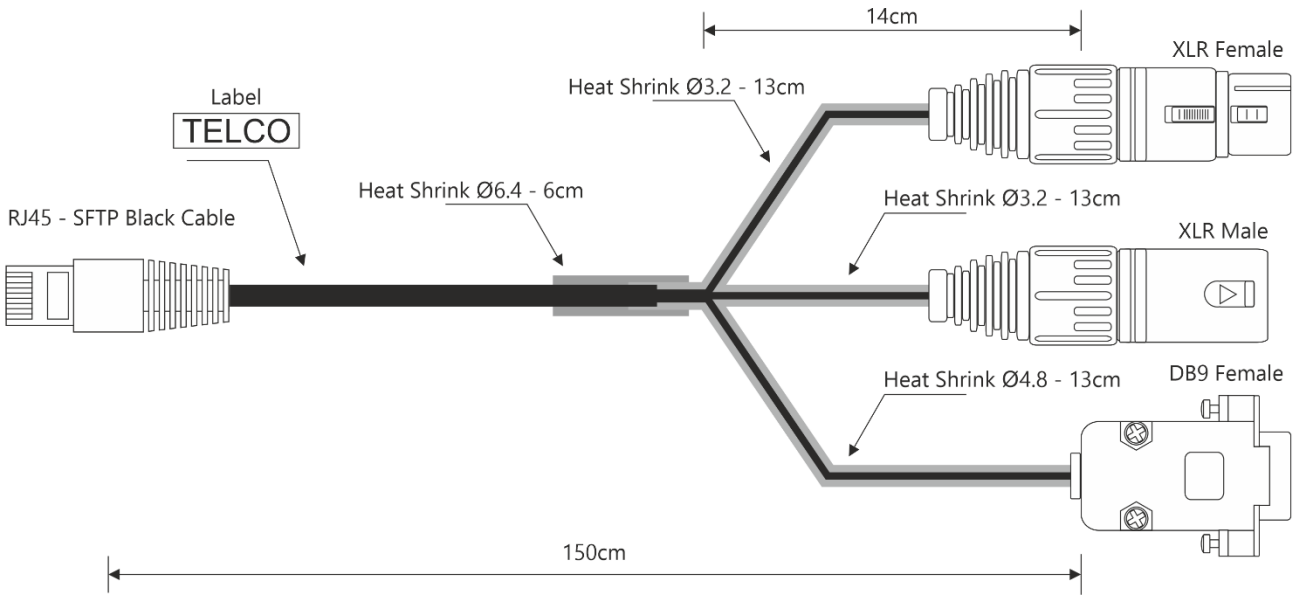

13 + 189 – OXY1000-OXY2000-RJ45-LINE-IN

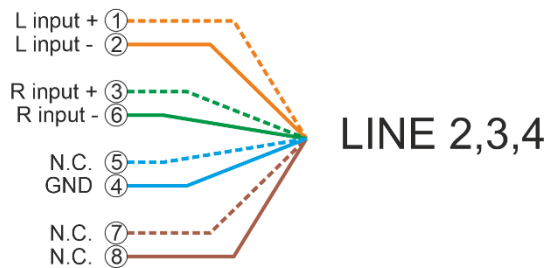
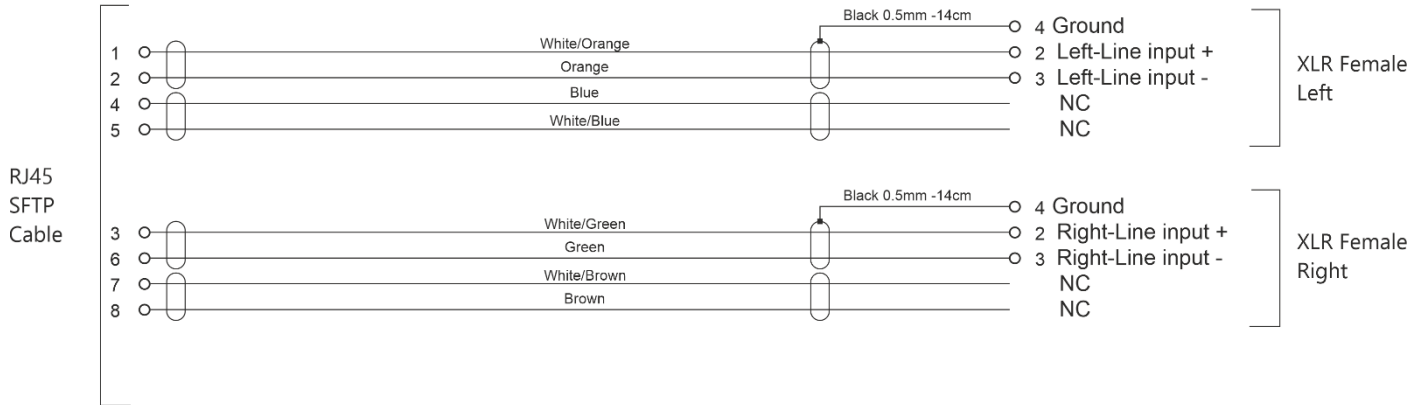
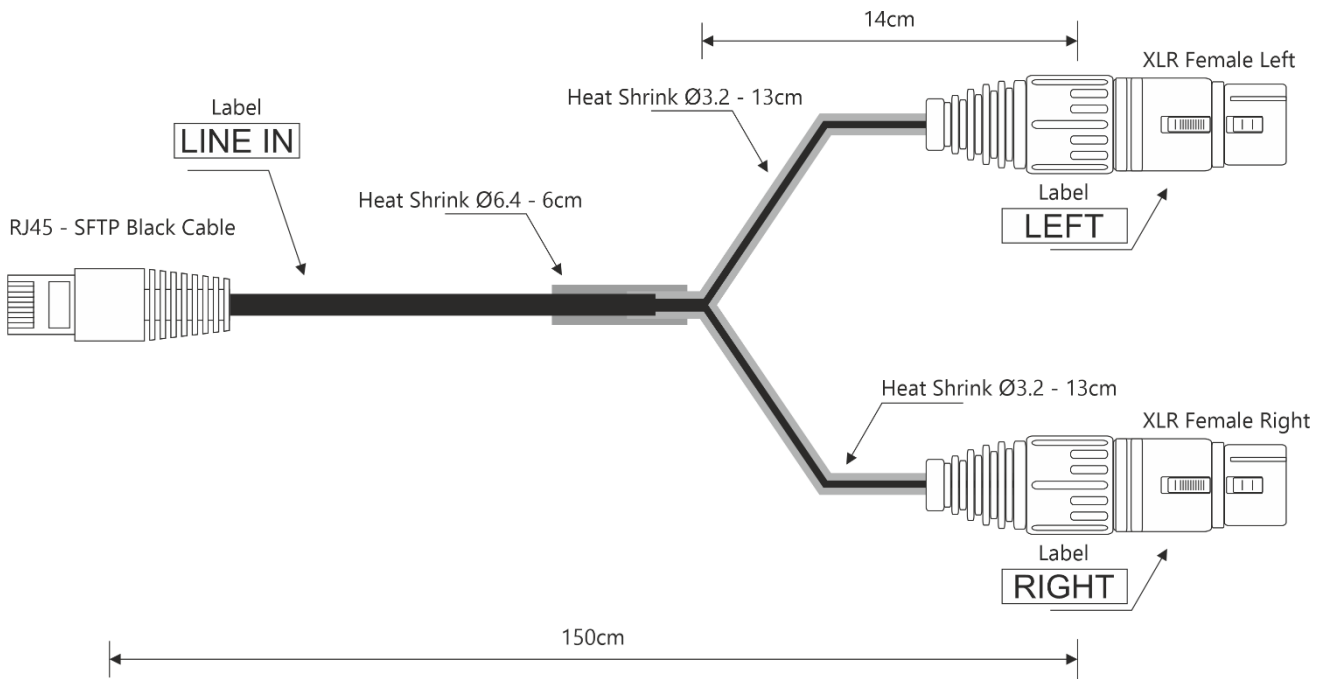

14 + 190 – OXY1000-OXY2000-RJ45-LINE-OUT

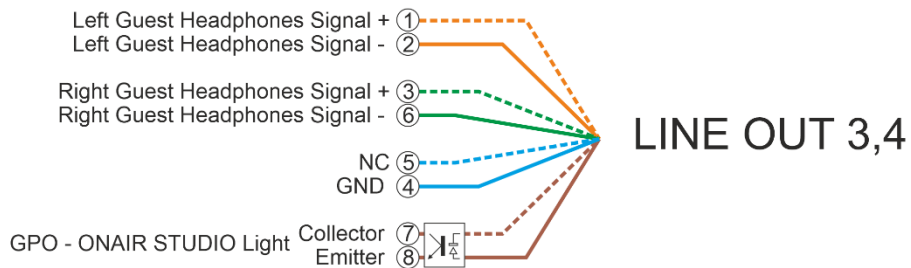
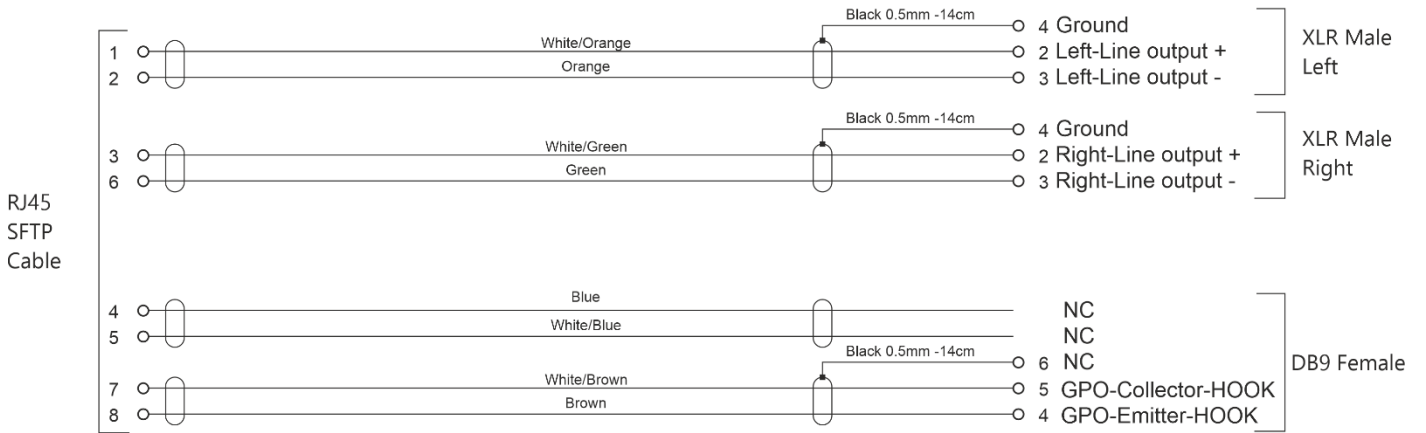
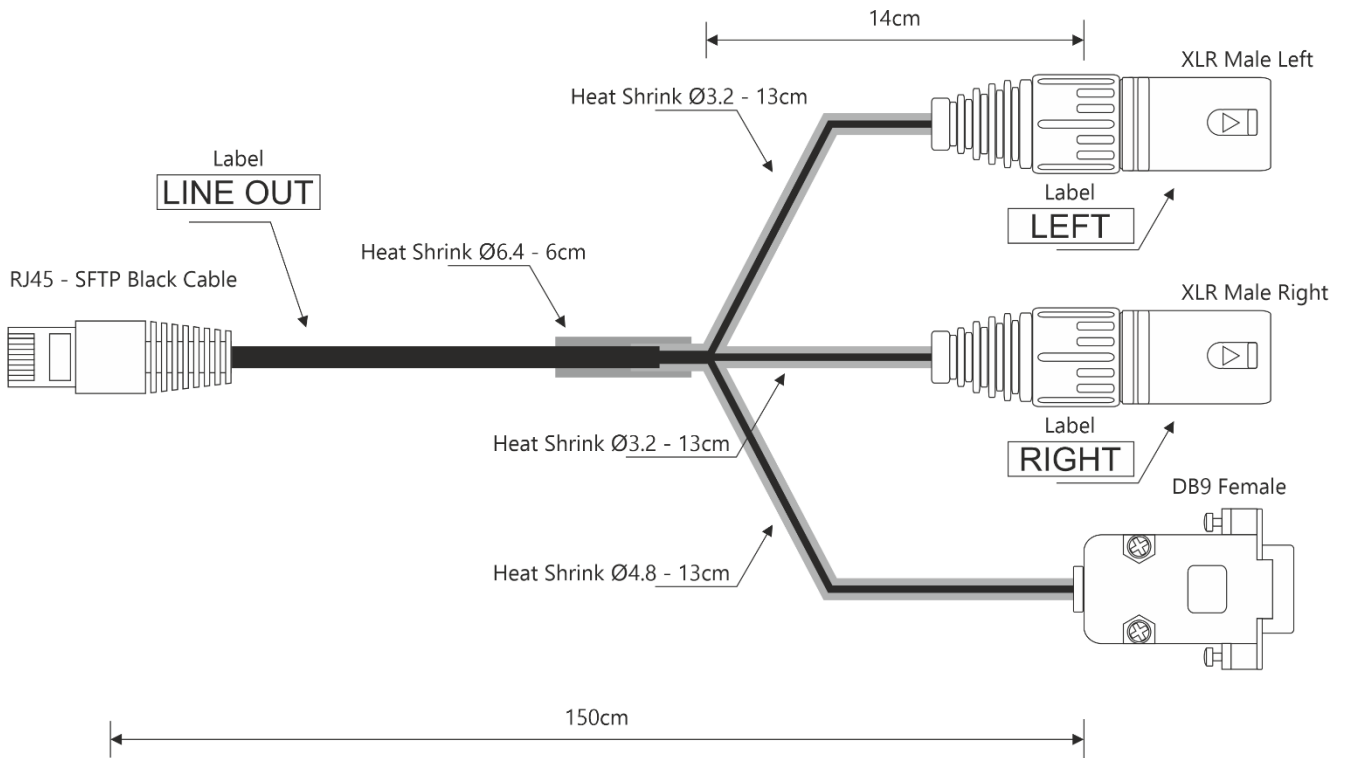

15 TECH SPECS

Analog Balanced Microphone Inputs

Connector	RJ45 & XLR Balanced – EMI Suppressed
Input Impedance	2,4 K Ω
Nominal Input Level (sensitivity)	-9/-66 dBu
Max Input Level (clipping point)	+9 dBu
A/D conversion	24 bit / 48 Khz
Signal To Noise Ratio (referred to peak level)	>90 dB
THD+N	<0,01%
Analog Gain	Adjustable +0 ÷ +57 dB (3dB step)
Phantom Power	+48V

Analog Balanced Stereo Inputs

Connector	XLR & RJ45 Balanced – EMI Suppressed
Input Impedance	10 K Ω
Nominal Input Level (sensitivity)	0 dBu
Max Input Level (clipping point)	+18 dBu
A/D conversion	24 bit / 48 Khz
Frequency response	+/-0,5 dB from 20 Hz to 20 kHz
Signal To Noise Ratio (referred to peak level)	>100 dB
Stereo Separation (referred to peak level)	>90 dB
THD+N	<0,002 %

Analog Balanced Telco Input

Connector	RJ45 Balanced – EMI Suppressed
Input Impedance	10 K Ω
Nominal Input Level (sensitivity)	0 dBu

Analog Balanced Telco Input

Max Input Level (clipping point) **+18 dBu**

A/D conversion **24 bit / 48 Khz**

Signal To Noise Ratio (referred to peak level) **>100 dB**

THD+N **<0,002%**

PSTN Interface

Connector **RJ11**

Transhybrid loss **>20 dB**

Analog Balanced Stereo Outputs

Connector **RJ45 Balanced – EMI Suppressed**

Output Impedance **23 Ω , nominal 600 Ω**

Nominal Output Level **0 dBu**

Max Output Level (clipping point) **+18 dBu**

D/A conversion **24 bit / 48 Khz**

Signal To Noise Ratio (referred to peak level) **>100 dB**

Stereo Separation (referred to peak level) **>90 dB**

THD+N **<0,002 %**

USB Audio Digital I/O

Connector **USB Type B – EMI Suppressed**

Playback And Recording Sample Rate **SRC 44.1-48 KHz**

Resolution **16 bit**

Available Stereo Channels **1 Play & 1 Rec for each USB interface**

Digital Output

Connector **Balanced on 1 XLR – EMI Suppressed**

Input Impedance **110 Ω**

Standard **AES3**

Audio Sample Rate **48 KHz**

Digital Output

Resolution 24 bit

Dynamic Range (Converter Values) 124 dB

Analog Balanced Telco Output

Connector RJ45 Balanced – EMI Suppressed

Output Impedance 23 Ω , nominal 600 Ω

Nominal Output Level 0 dBu

Max Output Level (clipping point) +18 dBu

D/A conversion 24 bit / 48 KHz

Signal To Noise Ratio (referred to peak level) >100 dB

THD+N <0,002 %

System

Audio Core Analog Devices ADAU1452 32bit 294 MHz fixed point DSP

Audio CODECs Cirrus CS42448 24 bit/192 kHz

System Core Allwinner A20 dual core cortex-A7 at 800MHz, 1GB RAM

LAN Connection RJ45 - 100Mbit

Nominal Delay (analog input to analog output) 0,7 ms

GPIO Inputs/Outputs 4 GPI/4 GPO on DB9; 4 GPI/2 GPO on Mic2 & Mic3 RJ45; 2 GPO on Out3 & Out4 RJ45; 1 GPI/1 GPO on Telco RJ45

Communication Port 2xUSB type-A, 2xUSB type-B , 1xLAN, 1xHDMI

Operating Temperature 0°C ÷ 40°C

PSU

Power Supply 90-260 VAC / 47-63 Hz / 30 W

Dimensions

Dimensions (W; H; D) – OXYGEN 1000

OXYGEN 1000
344mm; 80mm; 343mm

Dimensions (W; H; D) – OXYGEN 2000

OXYGEN 2000
614mm; 80mm; 343mm

Weight – OXYGEN 1000

OXYGEN 1000
< 5.0 Kg

Weight – OXYGEN 2000

OXYGEN 2000
7.1 Kg

WEEE DIRECTIVE – INFORMATIVA RAEE



In line with EU Directive 2002/96/EC for waste electrical and electronic equipment (WEEE), this electrical product must not be disposed of as unsorted municipal waste. Please dispose of this product by returning it to the point of sale or to your local municipal collection point for recycling.

In Übereinstimmung mit der Richtlinie 2002/96/EG des Europäischen Parlaments

und des Rates über Elektro- und Elektronik-Altgeräte (WEEE) darf dieses Elektrogerät nicht im normalen Hausmüll oder dem Gelben Sack entsorgt werden. Wenn Sie dieses Produkt entsorgen möchten, bringen Sie es bitte zur Verkaufsstelle zurück oder zum Recycling-Sammelpunkt Ihrer Gemeinde.

Conformément à la Directive 2002/96/EC sur les déchets d'équipements électriques et électroniques (DEEE), ce produit électrique ne doit en aucun cas être mis au rebut sous forme de déchet municipal non trié. Veuillez vous débarrasser de ce produit en le renvoyant à son point de vente ou au point de ramassage local dans votre municipalité, à des fins de recyclage.

In navolging van richtlijn 2002/96/EG van het Europees Parlement en de Raad betreffende afgedankte elektrische en elektronische apparatuur (AEEA) mag dit elektrische product niet als ongescheiden huisvuil worden weggedaan. Breng dit product terug naar de plaats van aankoop of naar het gemeentelijke afvalinzamelingspunt voor recycling.

In ottemperanza alla Direttiva UE 2002/96/EC sui rifiuti di apparecchiature elettriche ed elettroniche (RAEE), questo prodotto elettrico non deve essere smaltito come rifiuto municipale misto. Si prega di smaltire il prodotto riportandolo al punto vendita o al punto di raccolta municipale locale per un opportuno riciclaggio.

De conformidad con la Directiva 2002/96/CE de la UE sobre residuos de aparatos eléctricos y electrónicos (RAEE), este producto eléctrico no puede desecharse con el resto de residuos no clasificados. Deshágase de este producto devolviéndolo al punto de venta o a un punto de recogida municipal para su reciclaje.

I henhold til EU-direktiv 2002/96/EF om affald af elektrisk og elektronisk udstyr (WEEE) må dette udstyr ikke bortskaffes som usorteret husholdningsaffald. Bortskaf dette produkt ved at returnere det til salgsstedet eller til det lokale indsamlingssted, så det kan genbruges.

I linje med EU-direktiv 2002/96/EG om avfall som utgörs av eller innehåller elektriska eller elektroniska produkter (WEEE) får denna elektriska produkt inte bortskaffas som osorterat kommunalt avfall. Bortskaffa den i stället genom att lämna in den på försäljningsstället eller din lokala återvinningsstation.

EU:n sähkö- ja elektroniikkalaiteromudirektiivin (2002/96/EY) mukaisesti tätä elektroniikkalaitetta ei saa laittaa lajittelemattoman yhdyskuntajätteen sekaan. Hävitä laite palauttamalla se ostopaikkaan tai viemällä se elektroniikkaromun keräyspisteeseen.

De acordo com a Directiva Europeia 2002/96/EC sobre resíduos sólidos de equipamento eléctrico e electrónico (WEEE), este produto eléctrico não pode ser deixado fora juntamente com o lixo municipal indiferenciado. Por favor, no final da vida útil deste produto, devolva-o ao estabelecimento de aquisição, ou entregue no local de recolha apropriado para reciclagem designado pelo seu município.

V souladu se smrnici EU . 2002/96/ES o odpadních elektrických a elektronických zařizeniích (OEEZ) se tento elektrický výrobek nesmí likvidovat jako neřídny komunální odpad. PŮi likvidacento výrobek vraťte prodejci nebo ho odevzdejte k recyklaci do komunálního sbrného zařizení.

Vastavalt EL direktiivile 2002/96/EÜ, mis käsitleb elektri- ja elektroonikaseadmete jäätmeid (WEEE), ei või antud toodet visata majapidamisjäätmete hulka. Palun tagastage antud toode taaskasutamise eesmärgil müügipunkti või kohaliku piirkonna jäätmekogumise punkti.

V súlade so smernicou 2002/96/ES o odpade z elektrických a elektronických zariadení (OEEZ) sa toto elektrické zariadenie nesmie odstranovať ako netriedený komunálny odpad. Výrobok odstráňte jeho vrátením v mieste nákupu alebo odovzdaním v miestnom zbernom zariadení na recyklovanie.

V súlade so smernicou 2002/96/ES o odpade z elektrických a elektronických zariadení (OEEZ) sa toto elektrické zariadenie nesmie odstranovať ako netriedený komunálny odpad. Výrobok odstráňte jeho vrátením v mieste nákupu alebo odovzdaním v miestnom zbernom zariadení na recyklovanie.

WARRANTY

The manufacturer offers a one-year warranty ex-works. Do not open the equipment. Any breaking of the seals will result in forfeiture of the same. The manufacturer is not liable for damages of any kind arising from, or in connection with, the use of the wrong product.



Declaration of conformity

I the undersigned Giuseppe Vaccari	
as CEO Axel Technology S.r.l.	
based in: Via Caduti di Sabbiuno, 6/F – 40011 – Anzola Emilia (BO) - Italy	
VAT NUMBER: IT01735031203	
HEREBY DECLARE	
That the following equipment	
Model: OXYGEN 1000D	
Manufacturing date: See Serial Number label	SN Number: see Serial Number label
Has been manufactured following the following rules:	
<ul style="list-style-type: none"> • Directive 2014/53/UE know as “RED Radio Equipment Directive” • Directive 2014/35/UE know as “LVD Low Voltage Directive” • Directive 2014/30/UE know as “EMC Electromagnetic Compatibility Directive” • Directive 2011/65/CE know as “RoHS Restriction Of the use of certain Hazardous Substances in electrical and electronic equipment Directive” • Commission delegated directive (UE) 2015/863 of 31 March 2015 amending Annex II to Directive 2011/65/EU of the European Parliament and of the Council • Directive 2012/19/UE know as “WEEE Waste Electrical and Electronic Equipment Directive” • Directive 2001/95/CE Know as “General product safety” • UNI EN ISO 7010:2020 Title: Graphical symbols - Safety colours and safety signs - Registered safety signs • EN 62368-1:2018 - Audio/video, information and communication technology equipment • IEC 62311:2019 - Assessment of electronic and electrical equipment related to human exposure restrictions for electromagnetic fields (0 Hz to 300 GHz) • EN 301 489-1 V2.2.3 (2019-11) - ElectroMagnetic Compatibility (EMC) standard for radio equipment and services; Part 1: Common technical requirements; Harmonised Standard for ElectroMagnetic Compatibility • EN 301 489-17 V3.2.4 (2020-09) - ElectroMagnetic Compatibility (EMC) standard for radio equipment and services Part 17: Specific conditions for Broadband Data Transmission Systems; Harmonised Standard for ElectroMagnetic Compatibility • EN 300 328 V2.2.2 (2019-07) Wideband transmission systems; Data transmission equipment operating in the 2,4 GHz band; Harmonised Standard for access to radio spectrum • EN 55032:2015+A1:2020 - Electromagnetic compatibility of multimedia equipment. Emission requirements • EN 55103-2:2009 Product family standard for audio, video, audio-visual and entertainment lighting control apparatus for professional use – Part 2 Immunity. • EN 60065:2019 Audio, video and similar electronic apparatus - Safety requirements • EN 61000-6-1:2016 – EMC – Part 6.1 Immunity standard for residential, commercial and light-industrial environments • EN 61000-6-3:2020 – EMC – Part 6.3 Immunity standard for residential, commercial and light-industrial environments • EN 60950-1:2014 – Information Technology Equipment - Safety • EN 55024:2010+A1:2015 Information technology equipment. Immunity characteristics. Limits and methods of measurement • EN IEC 63000:2018 New Harmonized Standard to Demonstrate RoHS Compliance • EN 55032:2015+A11:2020 Electromagnetic compatibility of multimedia equipment - Emission Requirements 	
And it is therefore compliant to the current rules and laws.	
10/01/2022	Signature: 
ANZOLA DELL'EMILIA (BO) - ITALY	



Dichiarazione di conformità

Il sottoscritto Giuseppe Vaccari	
In qualità di legale rappresentante della ditta Axel Technology S.r.l.	
con sede in: Via Caduti di Sabbiuno, 6/F – 40011 – Anzola Emilia (BO)	
Partita IVA: IT01735031203	
Dichiara	
che il prodotto: Console Broadcast digitale.	
Modello e codice: OXYGEN 1000D	
Data Fabbricazione: VEDI ETICHETTA NR. DI SERIE	Numero di serie: VEDI ETICHETTA NR. DI SERIE
È stato costruito rispettando le seguenti direttive e norme:	
<ul style="list-style-type: none">• Direttiva 2014/53/UE nota come "Direttiva RED"• Direttiva 2014/35/UE nota come "Direttiva bassa tensione"• Direttiva 2014/30/UE nota come "Direttiva compatibilità elettromagnetica"• Direttiva 2011/65/CE nota come "RoHS"• Direttiva delegata (UE) 2015/863 della commissione del 31 marzo 2015 recante modifica dell'allegato II della direttiva 2011/65/UE• Direttiva 2012/19/UE nota come "RAEE"• Direttiva 2001/95/CE nota "Sicurezza generale dei prodotti"• UNI EN ISO 7010:2020 Titolo: Segni grafici - Colori e segnali di sicurezza - Segnali di sicurezza registrati• EN 62368-1:2018 - relativa alla sicurezza elettrica per le apparecchiature informatiche e i prodotti audio/video• IEC 62311:2019 - Valutazione degli apparecchi elettronici ed elettrici in relazione alle restrizioni per l'esposizione umana ai campi elettromagnetici (0 Hz – 300 GHz)• EN 301 489-1 V2.2.3 (2019-11) - ElectroMagnetic Compatibility (EMC) standard for radio equipment and services; Part 1: Common technical requirements; Harmonised Standard for ElectroMagnetic Compatibility• EN 301 489-17 V3.2.4 (2020-09) - ElectroMagnetic Compatibility (EMC) standard for radio equipment and services Part 17: Specific conditions for Broadband Data Transmission Systems; Harmonised Standard for ElectroMagnetic Compatibility• EN 300 328 V2.2.2 (2019-07) Wideband transmission systems; Data transmission equipment operating in the 2,4 GHz band; Harmonised Standard for access to radio spectrum• EN 55032:2015+A1:2020 - Electromagnetic compatibility of multimedia equipment. Emission requirements• EN 55103-2:2009 Norme di famiglie di prodotto per apparecchi audio, video, audiovisivi e di comando di luci da intrattenimento per uso professionale - Parte 2: Immunità.• EN 60065:2019 Apparecchi audio, video e apparecchi elettronici similari Requisiti di sicurezza.• EN 61000-6-1:2016 – EMC – Immunità per ambienti residenziali, commerciali e industria leggera.• EN 61000-6-3:2020 – EMC – Emissione per ambienti residenziali, commerciali e industria leggera.• EN 60950-1:2014 – Sicurezza degli apparati ITE (Information Technology Equipment)• EN 55024:2010+A1:2015 Apparecchiature per la tecnologia dell'informazione - Caratteristiche di immunità Limiti e metodi di misura.• EN IEC 63000:2018 New Harmonized Standard to Demonstrate RoHS Compliance• EN 55032:2015+A11:2020 Electromagnetic compatibility of multimedia equipment - Emission Requirements	
Ed è quindi conforme alle direttive e normative vigenti.	
La presente dichiarazione di conformità è rilasciata sotto la responsabilità esclusiva del fabbricante.	
Data: 10/01/2022	Firma: 
Luogo: ANZOLA DELL'EMILIA (BO) - ITALIA	