

The Complete Commentary Guide

Icon Key



One Commentator



Two Commentators



Three Commentators



Four Commentators



One Talkback Circuit



Two Talkback Circuits



Three Talkback Circuits



Four Talkback Circuits



One Headphone Output



Two Headphone Outputs



Three Headphone Outputs



Analogue System



Digital System



Battery Powered



Internal Mains Power



External DC Power



Stand Alone System



Multi-Part System



Fibre Connection in Multi-Part System



Copper Ethernet Connection in Multi-Part System



Multi Wire Connection in Multi-Part System



Coaxial Connection in Multi-Part System



CAT 5 Connection in Multi-Part System



GlenSound Electronics Ltd
 6 Brooks Place, Maidstone, Kent, ME14 1HE, UK
 Tel: +44 (0) 1622 753 662 Fax: +44 (0) 1622 762 330
 Email: sales@glen-sound.co.uk
 Web: www.glen-sound.co.uk

Table of Contents

History.....	4
UNITS FOR ONE COMMENTATOR	5
GS-CU004.....	6
GS-CU008.....	7
GS-CU010.....	8
UNITS FOR TWO COMMENTATORS.....	9
GS-VC1.....	10
GS-BC2.....	11
Express Box.....	12
UNITS FOR THREE COMMENTATORS.....	13
GS-CU001B.....	14,15
Talent Box.....	16,17
GS-OC26/24.....	18,19
GS-OC33/34.....	20,21
GDC-6432.....	22,23,24
UNITS FOR MULTI COMMENTATORS.....	25
GS-GC21/19/22.....	26,27
GS-CCU002/CU006.....	28,29
GS-GX3.....	30,31
Talent Box (multiple commentators).....	32
Headset and Mic Guide.....	33
Specifications.....	34-37
Q and A's.....	38,39
On Tour.....	40
GlenSound Commentary - Under the skin.....	41
Glossary.....	42,43

GlenSound Electronics Ltd. was established in 1966 by ex BBC engineer Len Davis. Initially, GlenSound's main role was designing new products to solve problems at the BBC. Custom design and solutions are still a key part of operations today, but this is joined now by key lines of tried and tested products in various audio product areas. The following chronological list details key moments in GlenSound's history.

- 1966 Len Davis leaves BBC designs department to concentrate on [public address designs](#) and equipment manufacture. Company called Glen Sound Services
- 1966 Len Davis invents the world's first [telephone balancing unit](#) for use on BBC Radio's first phone in programme 'It's Your Line'.
- 1967 [Audio mixers](#) designed for use in schools.
- 1969 First GlenSound design for the BBC of a [distribution amplifier](#) for Prince Charles' investiture
- 1971 First [semi-modular unitised mixing desks](#) designed and manufactured for the BBC
- 1973 MX6 range of [mixers](#) designed and manufactured for the BBC
- 1974 DK2/21 popular [monitoring & output unit](#) made for the BBC
- 1977 MICR (Mobile International Control Room) [specialist commentators' equipment](#) built for BBC
- 1978 Glen Sound Services becomes GlenSound Electronics Ltd
- 1980 Worlds first [assignable mixer](#) designed & manufactured for BBC Outside Broadcast.
- 1983 Design and installation of BBC [mobile studios](#)
- 1984 [Coaxial Commentators' equipment](#) designed for the BBC for use at the 1986 Commonwealth Games in Edinburgh, Scotland
- 1986 Gavin Davis joins GlenSound
- 1992 Design & supply of broadcast & [sound enhancement audio systems](#) for the House of Commons
- 1994 Introduction of the world's first portable, battery operated [ISDN Codec](#)
- 1994 Design & supply of broadcast & [sound enhancement audio systems](#) for the House of Lords
- 2001 Design & supply of broadcast & [sound enhancement audio systems](#) for the Greater London Authority
- 2002 Design & manufacture of 600 [commentators positions](#) (GS-OC33/34) for football World Cup in Korea and Japan
- 2003 [AES47 equipment](#) designed & supplied to the BBC
- 2004 The leading stand alone [commentary system GS-CU001](#) introduced
- 2005 Len Davis semi-retires and Gavin Davis appointed Managing Director
- 2006 Intelligent, [multi-zone, Ethernet controllable amplifier](#) designed for installation in all HSBC branches
- 2006 New [GSLC intercom system](#) designed and supplied for BBC local radio
- 2007 [Broadcasters' mobile phone GS-MPI004](#) introduced
- 2008 Eight thousandth [ISDN Codec](#) sold
- 2009 The world's first [IP controllable, digital commentary system, GDC 6432](#), is launched
- 2010 First stage delivery, of the next generation of the GlenSound's [Meeting Room Audio System](#) delivered to Committee Room 2 at the UK's House Of Lords.
- 2011 The world's first [hybrid commentary and intercom unit, the COIN GT-013](#) introduced in partnership with RTS/Telex
- 2011 The world's first digital stand alone commentary system, [The Talent Box](#), launched.
- 2011 The world's first broadcast [GlenSound HD Voice mobile phone](#) range launched,

At GlenSound we never stand still. We are always looking for ways to solve new problems encountered by broadcast engineers. Please talk to us if you would like help you with your new challenge, and who knows....the resultant product could end up joining our esteemed history list!

Units For One Commentator

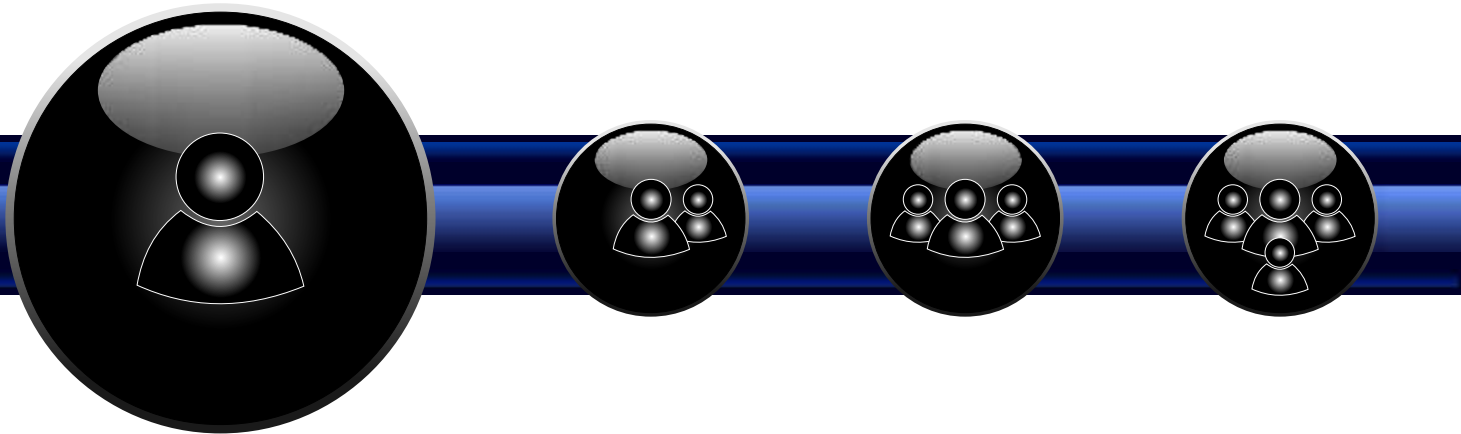

- GS-CU004** Battery powered, belt pack style unit with a single talkback circuit
- GS-CU008** Desktop single commentator's box, with options on talk back circuits
- GS-CU010** Small battery powered commentary unit cube, with a single talkback circuit, and optional 5 talkback send unit



Battery powered, belt pack style unit with a single talkback circuit

The GS-CU004 offers complete commentary functionality in the convenience of a small belt pack format.

- Main mic/line input is electronically balanced on XLR with adjustable gain control
- Input is switchable from line, mic, or mic + 12v phantom power
- Headphone output on 6.35mm jack socket
- Two outputs: one for main programme audio, one for talk back circuit, are both transformer balanced
- Independently configurable buttons for both outputs using Config+: latching, momentary or lazy
- Two inputs for headphone monitoring on XLR, both with adjustable level
- Headphone inputs have left/both/right switching
- Battery powered via 1 x 9v PP3
- External 12V DC power input



Inputs

The main input is switchable between mic, mic+12v phantom power, and line. The input has an adjustable gain control to meet a wide range of dynamic, condenser, and ribbon microphones. The input passes through a broadcast quality compressor/limiter circuit designed to manage the peaks of excited commentary.

Outputs/Talkback

There are two output circuits. One is used as the main programme audio, the other as a talkback circuit. There are separate button controls for each of these using Config+. They can each be independently configured for latching or momentary, with the programme button also having a 'cough' feature. Both outputs are transformer balanced.

Monitoring

There are two monitoring inputs each with independent level control. Each of these inputs can be switched from the left ear, right ear, or both ears. There is a 4 LED level meter from -6 to +6 dB.

Power

Battery power is from 1 x 9v PP3, or an external DC power supply.

The GS-CU004 is often used as a remote link to the main commentary unit. It is favoured by pitch side interviewers, and is popular in combinations with wireless systems.

Elevations

Front Panel

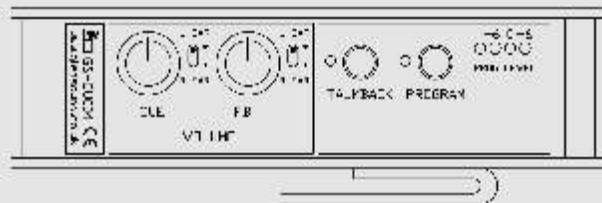

Rear Panel

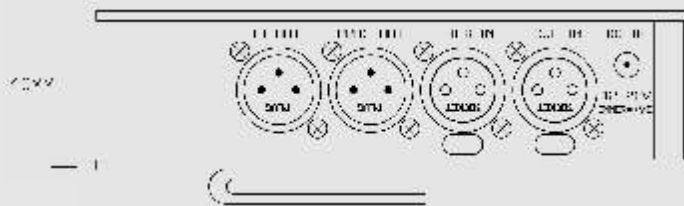

Left Side Panel

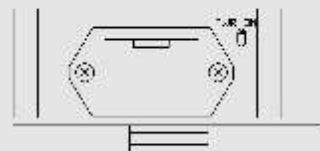

Right Side Panel

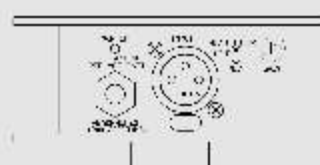

Features



GS-CU008



Desktop single commentator's box, with options on talk back circuits

The GS-CU008 is a popular general purpose mic and headphone interface. It's flexibility has resulted in various custom designs with multiple mic inputs, or multiple monitoring inputs. These options can interface with wireless systems, or be used for audio description

- Single mic input with selectable 48v phantom power
- Band pass filter optimised for voice
- Transformer balanced inputs and outputs
- Output level feature limiter on/off, or extra headroom mode
- Available with no talkback circuits, or add as many as required
- Any talkback circuits that are added feature Config+
- LED PPM meter with 7 segments
- Commentator's headphone output on 6.35mm jack socket (A or B gauge)
- Headphone inputs have level control and left/right/both switching
- Commentator side tone level control



Inputs

The front panel input is transformer balanced at microphone level with a selectable 48v phantom power switch. A small pot is on the front panel for adjusting gain control, and the mic on/off switch can also be set to act as a cough switch. For optimising the voice input, a band pass filter is used.

Outputs/Talkback

The standard unit features a single transformer balanced programme output. The output level is configurable by a three position selector switch which would typically be used with the compressor / limiter active above 0dB. The limiter can also be turned off for a 0dB output. If the compressor / limiter is not required, but more headroom is, the user can select a -10dB output without compressor/limiter. As each extra talkback circuit is added, a corresponding XLR output is added. Talkback buttons feature Config+ and can be configured as either lazy or momentary.

Monitoring

There is a single audio input with a variable pot for headphone monitoring for a single commentator, with a control for adjusting sidetone level in the headphones. Each additional talkback circuit will add an additional pot for headphone monitoring. All pots have left/both/right headphone switching so to adjust any input to either side of the headphones. The operator has a single 6.35mm headphone socket. There is a 7 segment LED PPM meter.

Power

Internal switch mode power supply 90-240v AC. An external power input is also provided on a 4 pin XLR 10-18v DC.

Elevations

Top Panel

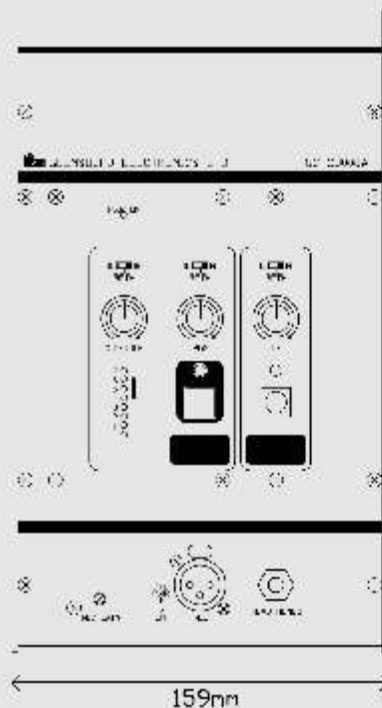

Side Panel

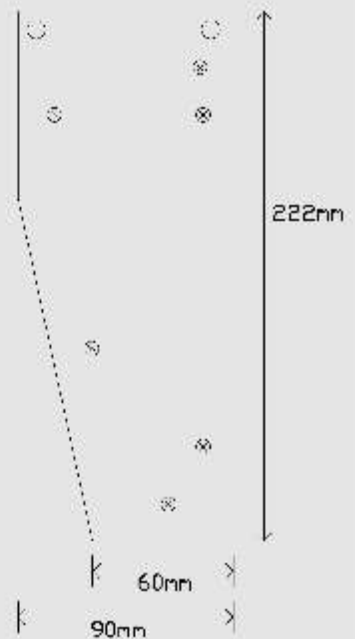

Rear Panel

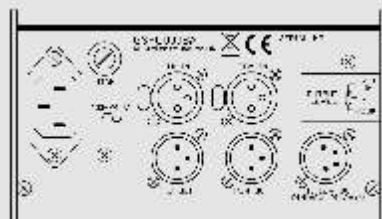

Features



For a block diagram please visit www.glen sound.co.uk
For technical specifications please see page 34



Small battery powered commentary unit cube, with a single talkback circuit, and optional 5 talkback send unit

The GS-CU010 is the choice if you need a small, battery powered desktop commentary unit. The cube shape gives a small footprint so is useful if space is limited. The GS-CU010 contains 1 talkback circuit. The optional GS-CU010A unit is the same footprint as the standard unit and contains five buttons for extra talkback sends. The GS-CU010A can be added as an upgrade at any time.

- One mic input, with gain control, compressor/limiter, and 12v phantom power
- Main output with additional talkback output, then 5 additional talkback outputs on GS-CU010A
- Mic on/off and talkback buttons feature Config+
- Two headphone monitoring inputs with left/both/right headphone switching
- CAT5 cable link between units
- Each unit powers via external DC or battery power (4 x AA)



Inputs

The mic input has adjustable gain and a switch to select 12v phantom power.

Outputs/Talkback

The main GS-CU010 unit has two outputs and the GS-CU010A unit has an additional 5 outputs. Each output has its own talkback switch featuring Config+ that can be programmed for lazy or momentary operation.

Monitoring

The GS-CU010 has two monitoring inputs with independent level control pots. Both inputs have left/both/right switching for the operator to adjust the mix balance to their preference. There is a front panel 6.35mm jack socket for a single commentator. Sidetone is selectable on/off via a front panel switch.

Power

The power requirements of both units are independent and identical. The battery caddy holds 4 x AA cells, or an external 12 to 20v DC power supply can be used.

The GS-CU010 is a very cost effective headphone/microphone interface. It is popular when space is limited and battery portability is required. The addition of the GS-CU010A talkback unit is a useful option especially as even if it is not needed at first, it is good to know that it can be a simple upgrade, and there will be no need to replace the main commentary unit first.

Elevations

Front Panel

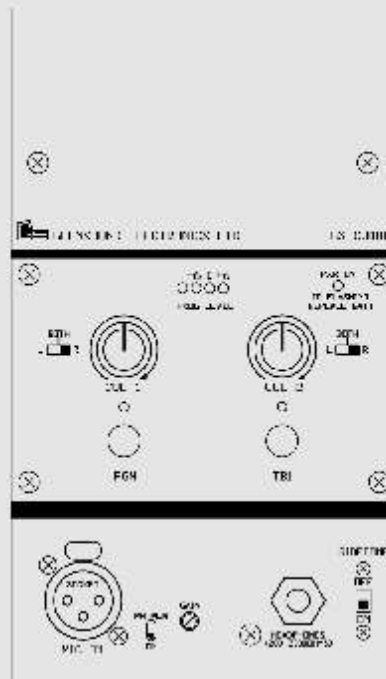

Left Side Panel

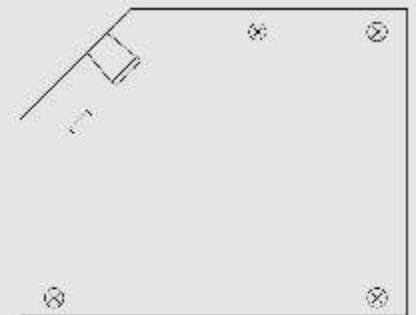

Rear Panel

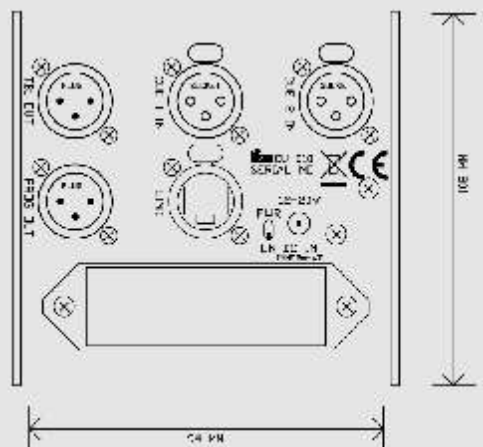

Features



Units For Two Commentators

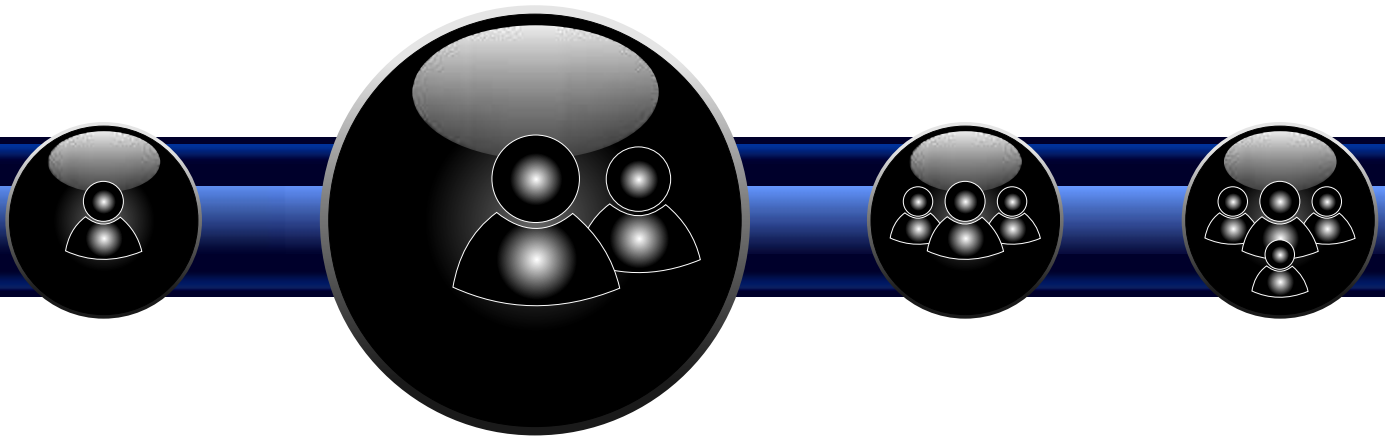

- GS-VC1 Two commentators' unit with individual talkback channels
- GS-BC2 A two commentator unit with switching options
- Express Box Basic two commentators box

The GS-VC1 presents the commentary facilities in a slightly different way to other units. Individual monitoring pots are per ear (rather than a switch for balancing), and a separate cough button is available alongside the mic on/off button.



Two commentators' unit with individual talkback channels

- Two independent commentators' positions
- Two transformer balanced mic inputs (12v phantom power via internal link)
- Single talkback circuit for each commentator
- Individual cough buttons
- Three external inputs for monitoring (2 shared, plus 1 exclusive talkback return each)
- Inputs and outputs on Varicon (GS-VC1A) or XLR (GS-VC1X)



Inputs

Each commentator has their own transformer balanced mic input on XLR, with 12v phantom power available via an internal link. These inputs feature a compressor/limiter circuit. In addition to the mic on/off button, each commentator also has an independent cough button.

Outputs/Talkback

Each mic output is available individually on the rear panel. Each commentator also has an independent talkback circuit that is available individually on the rear panel, and is activated by their own talkback button on the top panel. Two different versions are available with options on rear panel connectors: GS-VC1A uses a single Varicon connector, GS-VC1X uses XLR connectors.

Monitoring

Headphones are connected via individual front panel 6.35mm jack sockets. Both commentators have a shared source of 2 external inputs plus an individual input that is usually used for their own talkback return. Each commentator has controls available to make an independent level and balance mix of the available sources with each input having separate level controls for the left and right ear.

Power

Internal switch mode power supply 100-250v AC.

The GS-VC1 is an interesting unit with its un-usual combination of features. This makes it suitable for traditional commentary and off tube work, but also for the non-traditional requirements such as interpreting.

Elevations

Top Panel

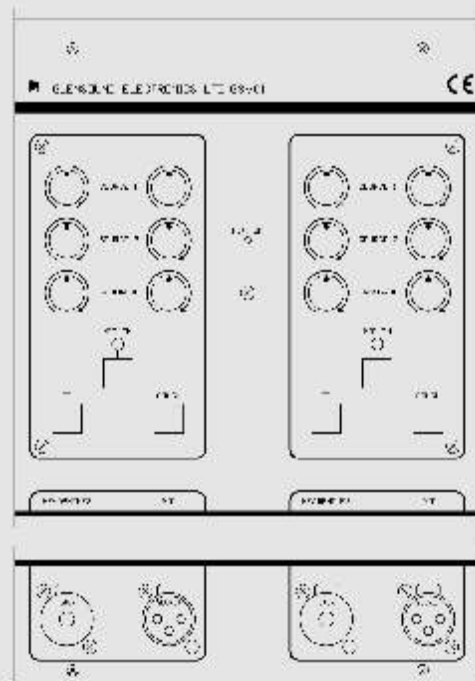

Side Panel

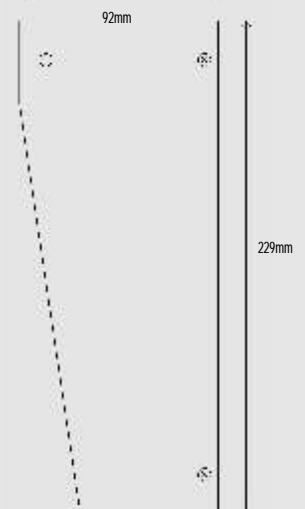

Rear Panel



For a block diagram please visit www.glen-sound.co.uk
For technical specifications please see page 34

Features



GS-BC2



*A two commentator unit
with switching options*

The GS-BC2(A) offers some interesting options when the operator may need to switch an output on and off regularly – if used with a PA for example. Another example is when they would like expert advice or guidance during the broadcast, to be fed directly into their headphones – a non broadcasting technical expert for example.

- Two commentator positions
- Mic inputs with switchable 12v phantom power
- Two selectable options on output configuration
- Two common talkback circuits
- Four external inputs for headphone monitoring
- Individual sidetone for each commentator
- 45dBs of headroom
- Balanced 50ohm outputs can drive long line lengths
- High quality audio with wide bandwidth and low noise
- Internal battery back up



Inputs

Individual XLR mic input for each commentator with selectable 12v phantom power. Each input has separate mic on/off buttons.

Outputs/Talkback

Two common talkback circuits are activated by top panel talkback buttons. Two master programme outputs on XLR have two modes of operation within each of the two available model options:

GS-BC2: Two main programme outputs are identical and a mix of both commentators' mics. The second programme output can be cut using the top panel yellow switch.

GS-BC2A: Programme 2 output is always commentator B mic. Programme 1 is either 1) commentator A mic, or 2) a mixed output of commentator A and B. This is selectable by the top panel yellow switch.

A top panel switch can route commentator B's mic signal to either the programme output or to the headphone monitoring of commentator A.

Monitoring

A 6.35mm jack socket is available for each commentator. Each commentator has 4 common sources for headphone monitoring with an additional pot allowing sidetone monitoring control of their own voice. Commentator A has a level control of the commentator B audio. The monitoring of commentator B is only active if the top panel red switch re-routes the audio of commentary B from the programme outputs to the commentator A headphones. Each input has its own pot for level control.

Power

There is a rear panel on/off switch and an internal switch mode power supply 100-250v AC. There is an internal automatic battery back up.

Elevations

Top Panel

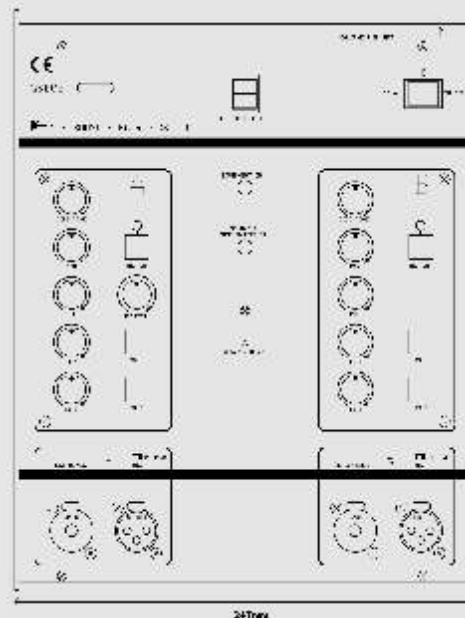

Side Panel

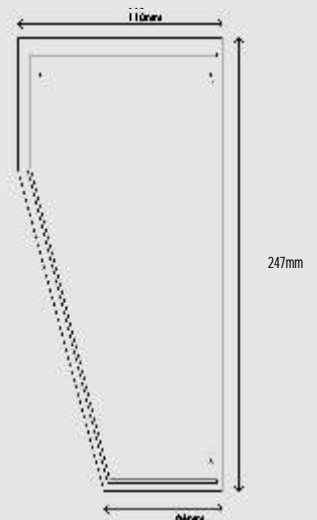

Rear Panel

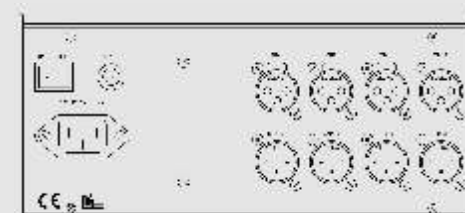

Features



For a block diagram please visit www.glen-sound.co.uk
For technical specifications please see page 34

The Express Box was designed to provide a quick and easy solution when it is necessary to provide interfacing for two commentators, with simple facilities. This high quality commentary unit is ideal for those looking for cost effective solutions without paying for unwanted features; the Express Box is worthy of investigation.



A high quality, no frills approach for 2 commentators

- Two commentary positions
- Four external monitor inputs plus sidetone
- Two common talkback circuits
- Operation of talkback buttons configurable
- Mic inputs with selectable 48v phantom power
- 7 LED PPM meter
- Easy to use and cost effective



Inputs

Two front panel mic inputs with selectable 48v phantom power.

Outputs/Talkback

Each mic input has its own individual output. There is also a mixed output of the two mic inputs. The two talkback circuits have individual outputs and are common for both commentators.

Monitoring

There are four inputs for external sources, and one sidetone pot of their own voice. These are available independently to each commentator on individual pots, so each can adjust the inputs for their own preference of mix level. There are two 6.35mm headphone sockets - 1 for each commentator. A 7 segment LED PPM meter displays level.

Power

Power is via an internal switch mode power supply from 100-240v AC.



Elevations

Top Panel

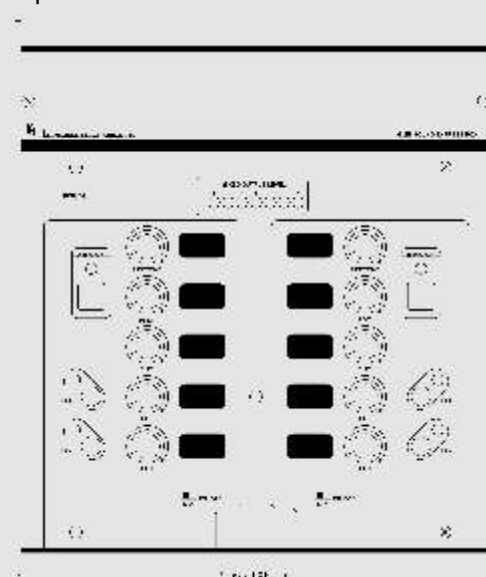

Side Panel

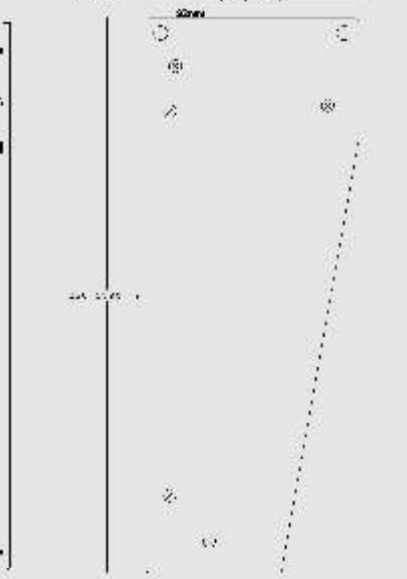

Rear Panel



Features



For a block diagram please visit www.glen-sound.co.uk
For technical specifications please see page 35

Units For Three Commentators

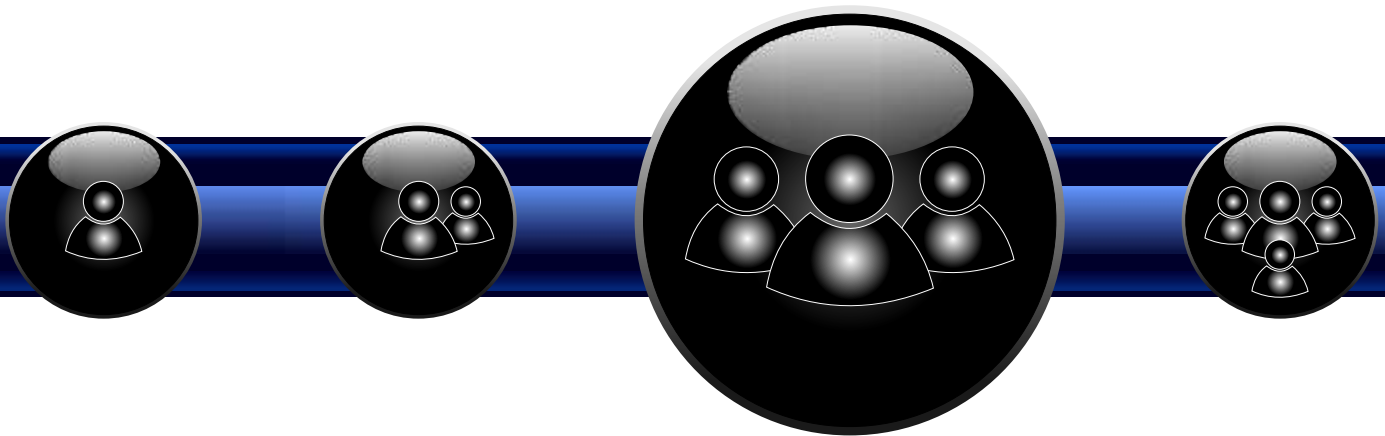

GS-CU001B

Talent Box and Remote

A 3 commentators' unit with comprehensive features and options

The most powerful and advanced single unit commentary system available

GS-OC26/OC24

Analogue two part commentary system using coax

GS-OC33/34

A 2 part analogue commentary system as part of a multiple commentary control base station

GDC-6432

Powerful and versatile digital commentary system with three linking options

The GS-CU001B is a highly versatile commentary unit. It was designed after close consultation with end users and the result is a stand alone unit which offers a wide range of facilities, and it is equally at home on the terraces, as it is in a studio.



A 3 commentators unit with comprehensive features and options

- Positions for 3 commentators
- 3 x mic/line inputs with 12v phantom power (48v option)
- Individual outputs plus a mixed output
- 5 external inputs for monitoring plus sidetone
- Output compressor / limiter
- 3 common talkback outputs with Config+ push buttons
- 7 segment LED PPM
- Many custom options available
- Options on electronic and transformer balancing



Elevations

Top Panel

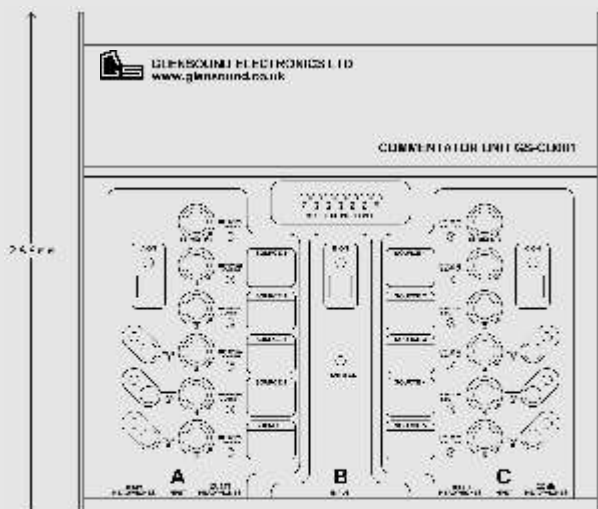

Side Panel



Rear Panel

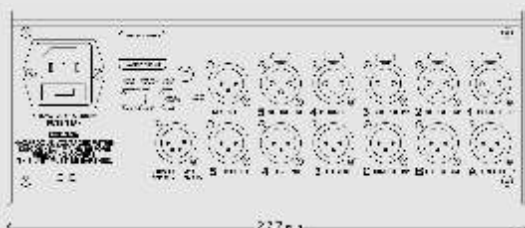

Inputs

Three front panel inputs are mic/line switchable with selectable 12v phantom power (48v option). The front panel also has a small gain adjustment pot. Mic on/off switches can be selected in on/off mode or in cough mode. There is a global low frequency cut that can be selected on or off, and a preset compressor/limiter per input.

Outputs/Talkback

Each input has a direct discrete output on the rear panel along with a mixed output of all of the inputs, all on XLR. The mixed output is also available on an un-balanced 3.5mm jack socket as a local record. The direct output levels can be set in 3 positions:

- 1: 0dB + limiter: This is the normal operation and it limits peak levels.
- 2: 0dB: This feeds the output with an un-compressed nominal level of 0dB, for when the peak signal level will be controlled by outboard equipment.
- 3: -20dB: This feeds the output with a nominal level of -20dB providing extra headroom.

There are 3 common talkback circuits with individual buttons on the two main commentators' sections (Position B's input cannot be switched to a talkback output). The operation of the talkback buttons features Config+ for configuring in different modes.

Features





Monitoring

There are two main commentator monitoring sections, each with two separate 6.35mm A or B gauge jack sockets for headphones. In this way, the centre position B commentator can choose to share the monitoring of commentator A or C. There are 5 common external sources available for monitoring, plus an additional control which is the sum of the other 2 commentators/inputs. Each of the 6 pots has variable level control and left/both/right switching allowing commentator A and C to achieve their desired mix and balance levels. The sidetone control is located on the rear panel for commentator A and C to adjust the level of their own voice. There is a 7 segment LED PPM meter.

Power

There is an internal switch mode power supply 100-250v AC, with external power via a 4 pin XLR 9-18v DC.

Flight Case

By popular demand a hard wearing strong polypropylene flight case is now available for all of the GS-CU001 range. It features long life hinges, easy to use catches and being made out of hardwearing polypropylene plastic, it will last for years. Internally the case is lined with cut out medium density foam. The multipurpose cut outs can be adapted to accept any of the different size GS-CU001 units. A second small cut out is included suitable for two HMD25 headsets & mains cable.

Multiple versions of the GS-CU001 are available:

GS-CU001D

In addition to the normal features of the GS-CU001, the D version provides an additional talkback channel between the 2 commentators.

Size 277x266x105mm

GS-CU001E

In addition to the GS-CU001D the E version brings the sidetone pot to the front panel (with a smaller knob than other headphone controls). Additionally there are 2 completely passive outputs from the 2 main commentators mics. The E version adds 4 individual inputs for each of the 2 headphone amps, allowing each commentator to listen to 4 different sources. For ease of wiring it is possible to switch any of these 4 inputs to both the headphone amps.

Size: 277x289x123mm

GS-CU001F

This is similar to the GS-CU001B, but it does not have sidetone. The sixth headphone level control is the mixed output of all the mic/line inputs.

Size 277x266x105mm

GS-CU001G

In addition to the normal features of the GS-CU001B, the G version has full size sidetone pots on the front panel, and 1 extra audio input into the headphone amps. There are 3 individual inputs for the 2 headphone amps, with switching to allow 1 of these inputs to be sent to both headphone amps.

Size: 277x289x123mm

GS-CU001L

Based on the GS-CU001E, the L version offers a choice of 2 separate inputs for each of the main commentators mics (A and C). To accommodate the extra inputs it is physically wider than the normal version at 345mm. Each of the main commentators inputs is mic/line/mic + phantom power selectable. For each of the 2 main commentators inputs, a recessed front panel toggle switch selects which of the 2 inputs is routed to that commentators outputs. 48 Volt phantom power is also supplied instead of 12 volt phantom power.

Size 345x289x123mm

Input And Output Balancing

Any version can be provided with electronic or transformer balancing:

VERSION 1 (EE): Has electronically balanced audio input & output circuits.

VERSION 2 (ET): Has electronically balanced inputs with transformer balanced outputs.

VERSION 3 (TT): Has transformer balanced inputs & outputs with high quality Lundhall transformers on the individual mic outputs.

Modifications

The GS-CU001 is a complete and versatile base system, and Glensound's most popular commentary unit. It is therefore a perfect starting point for custom requirements. This has resulted in many custom modified units, some listed above, and some not. We are always happy to investigate a particular requirement that you may have. To give you an idea of what is possible, these are some of the modifications, we have designed previously for others:

- Added 48v phantom power and GPIO on a 9 pin D-type
- Moved the sidetone control to the top panel on a full size pot
- Added a talkback channel and monitor between the A and C commentary positions (GS-CU001D and E)
- Independent monitoring inputs for commentator A and C (GS-CU001E)
- Additional mic passive outputs (GS-CU001E)
- Added an additional headphone monitoring input (GS-CU001G)
- Added two mic inputs for commentator A and C with a simple toggle switch between them (GS-CU001L)



The most powerful and advanced single unit commentary system available

The GlenSound Talent Box is the next generation of single unit commentary systems. Digital in both control and internal audio circuits with extended positions, gives each commentator their own remote control unit. A web page allows an engineer to remotely control incoming audio levels - a first for a single unit commentary box. Talent Boxes can also link for multiple commentator systems.

- Fully digital operation and control
- Fully featured remote controls for every commentator
- Remote control of gains via web page
- Five external sources for monitoring
- Three talkback buttons with Config+
- Analogue I/O option has transformer balancing options
- Digital I/O option (AES 3)



Elevations

Talent Box Front Panel

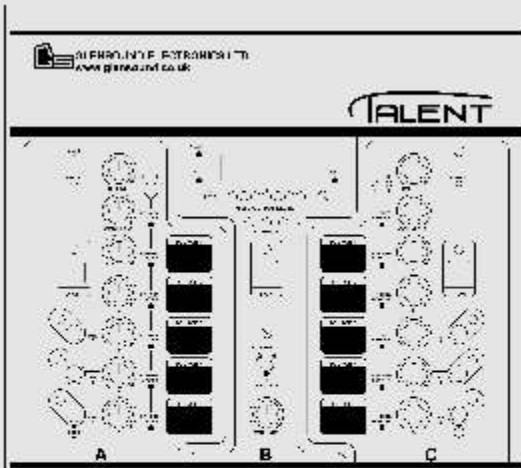

Talent Box Side Panel



Talent Remote Rear Panel

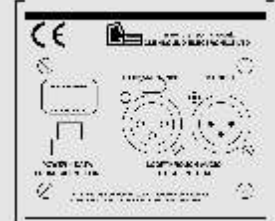

Talent Remote Front Panel



Talent Remote Side Panel

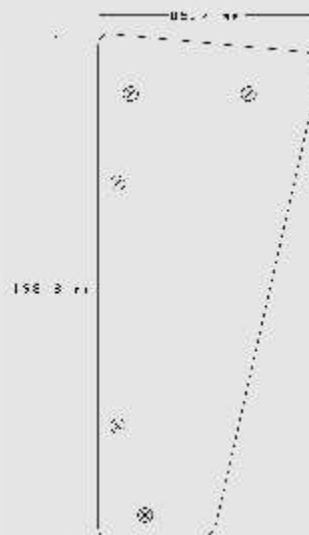

Talent Remote Top Panel

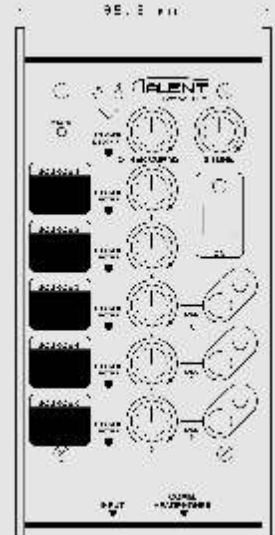

Talent Box Rear Panel



TALENT BOX



Talent Box

CMBuss System Linking

This facilitates the linking of multiple Talent Boxes, allowing programme and talkback inputs and outputs to connect to a single unit, but be shared across all connected units. Multiple commentators can therefore be added to a single programme – 30 or more if required! All mixed programme outputs on every connected Talent Box will be a mix of every input from every box. Individual direct outputs are still available on each individual box. CMBuss features link technology only available to Glensound which provides quick, trouble free linking in harsh outside broadcast environments. See page 32 for further information.



Talent Remote

Talent Box

Inputs

Three front panel inputs on XLR are mic/line switchable. Input B has an additional parallel input on a 3.5mm jack socket. There is an adjustable gain control and a phantom power switch to add 12v or 48v phantom power (this can be locked on/off in the configuration menu). The mic on/off button can also be configured as a cough button. The inputs have a configurable compressor/limiter.

Outputs/Talkback

There are three direct outputs of the mic/line inputs. These are at adjustable level with optional limiter. There are two configurable master outputs, that are a mix of the three inputs. An unbalanced 3.5mm jack socket is available as a local record out. There are three common talkback outputs with Config+ push buttons, which are level adjustable to match an external talkback system. A digital line ident is provided and is controllable via a rear panel switch, which gives a looped message and 1.6kHz tone to the outputs.

Monitoring

With two fully featured commentators' positions A and C, the centre B position has no access to the talkback circuits (unless using external remote) and can choose to share monitoring with commentator A or B. The three headphone connections are via front panel 6.35mm jack sockets. There are five variable pots for external source level mixing, one pot for the commentators sidetone, and one for monitoring the other two inputs. Each of these inputs (ex sidetone) has soft headphone switching between left/both/right ears. Two of the external source pots can be linked to a single pot to provide a control for an incoming stereo signal – useful for the commentator to monitor dual channel international sound. Incoming talkbacks have LEDs that illuminate if audio is detected for operators to identify the talkback source.

Remote Control/Other

A network connection on CAT5, allows an engineer on a remote web browser to connect and adjust the input gain levels. Configuration settings on the Talent Box can be locked by the engineer to avoid unwanted changes.

Talent Remote

USB Remote Controls

A locking and secure USB connection links out to a fully featured commentary position with access to all monitoring and talkbacks exactly as the main unit top panel. Using the Talent Remote, allows each commentator more space as the remote is a small desktop unit, and gives them direct access to their own controls. Headphones and microphones connect to the front of the main Talent Box as normal. Using a Talent Remote will give the centre B commentator a fully featured set of controls that are not available on the main unit.

A network connection on RJ45 allows an engineer on a remote browser to connect and adjust the input gain levels. Configuration settings on the Talent Box can be locked by the engineer to avoid unwanted changes.

Power

Internal switch mode power supply 100-240v AC. External 9-18v DC power input on 4 pin XLR.

Features



This system connects the GS-OC26 1U base station to the GS-OC24 Commentators Box via a standard coaxial cable. All communications and programme lines including the power for the commentators box are carried by this connection.



Analogue 2 Part Commentary System Using Coax

- 3 commentary positions
- Separate 1U 19" Commentary Control Unit
- Mic inputs with 12v phantom power
- Inputs feature a compressor limiter and automatic gain control
- 5 external monitoring inputs
- 1 talkback circuit
- Coaxial link between units allows up to 500m range



Elevations

Front Panel

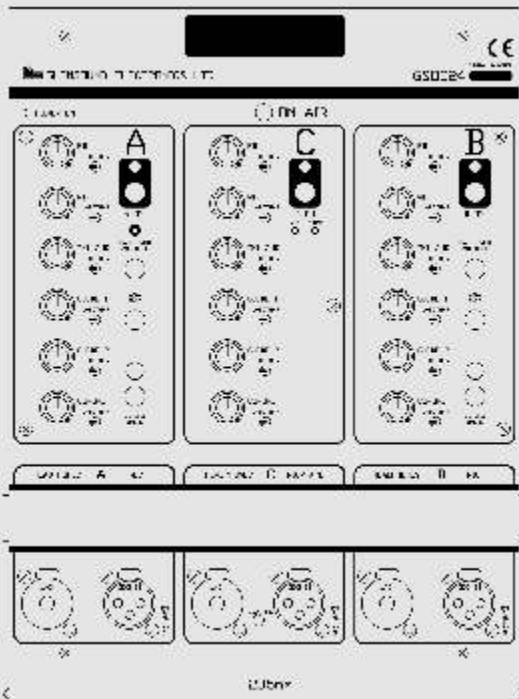

Side Panel



GS-OC26 Front Panel



Rear Panel



GS-OC26 Rear Panel





GS-OC26 Commentary Control Unit

Link

The system links via coaxial cable. Using suitable cable, the GS-OC24 can be up 500m away from the GS-OC26. The link carries bi-directional audio, data, and remote power for the GS-OC24 via its cable connection, omitting the need for local power. Multiple GS-OC26s can also be linked for sharing of monitoring where one engineer can easily control multiple systems whilst being connected to only one.

Extras

There is a call function enabling the two main commentators, the engineer, and the co-ordinator to call each other.



GS-OC24 Commentators Unit

GS-OC26 Commentary Control Unit

Inputs

There is a front panel microphone for the engineer. International sound comes in via a rear panel 'D' connector.

Outputs/Talkback

An additional talkback circuit is available only to the engineer on the GS-OC26. All rear panel audio input/output are on 'D' type connectors. There are direct outputs of the 3 commentator inputs plus a mixed programme output of all commentator inputs. A single common talkback output, plus the engineers talkback output are available. The rear panel also features 2 outputs for local monitor speakers. The front panel has an output mixer to mix levels between the 3 commentary unit inputs, and the international sound. In addition, the front panel features two line idents, one for the programme output and one for the co-ordination talkback circuit.

Monitoring

The engineer can monitor all audio via a front panel 6.35mm jack socket for headphones or via the rear panel monitor outputs for loudspeakers (audio on these is identical). The two channels each have a level pot for independent channel adjustment. The engineer can monitor all inputs and outputs via front panel push buttons which are pre-defined across the left or right monitoring channels. There is a 14 segment LED PPM meter.

Power

The GS-OC26 has an internal switch mode power supply 110-240v.

GS-OC24 Commentators' Unit

Inputs

There are 3 inputs via front panel XLRs where two are mic inputs and the centre position is mic/line switchable. Each input has a separate compressor/limiter and an automatic gain control, in addition to selectable 12v phantom power.

Outputs/Talkback

There is one talkback circuit that can be accessed via push buttons by commentator A & C on the GS-OC24, and the engineer on the GS-OC26. The rear panel of the GS-OC24 also has an XLR output of the main programme.

Monitoring

Each of the 3 commentators has 6 input pots plus a 7th source from the technician (for talkback - this has no level control) for creating their own headphone mix. Five of these are external inputs and 1 is the mix of all the microphone inputs. The commentators headphones connect on the front panel via 6.35mm jack sockets.

Power

The GS-OC24 is powered via the coaxial link to the GS-OC26.

Features





A 2 part analogue commentary system as part of a multiple commentary control base station

This system was developed for large sporting events to make the sharing of joint resources (such as international sound) easily accessible. This makes the whole system easier to manage and means that the operation of multiple channels is possible with fewer engineers.

- 2 part analogue system with a master commentary control base station
- Desktop base station with a modular design to allow a single engineer to control up to 10 programme channels
- One GS-OC33 channel card plus one GS-OC34 equals one independent programme channel
- Modular base station gives excellent resource sharing between GS-OC33s in large events
- GS-OC34 has three commentary positions
- Each GS-OC34 has 6 monitoring sources and 2 talkback circuits
- Two line idents
- Redundant power supply option



Elevations

Front Panel

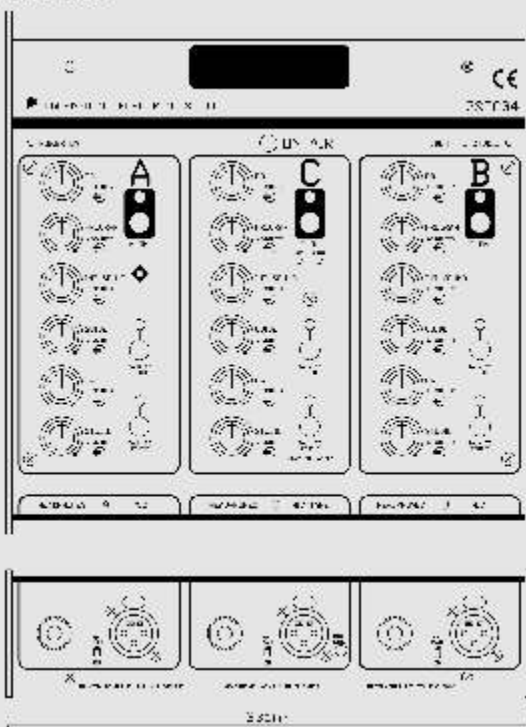

Rear Panel



Side Panel



GS-OC33 Panels

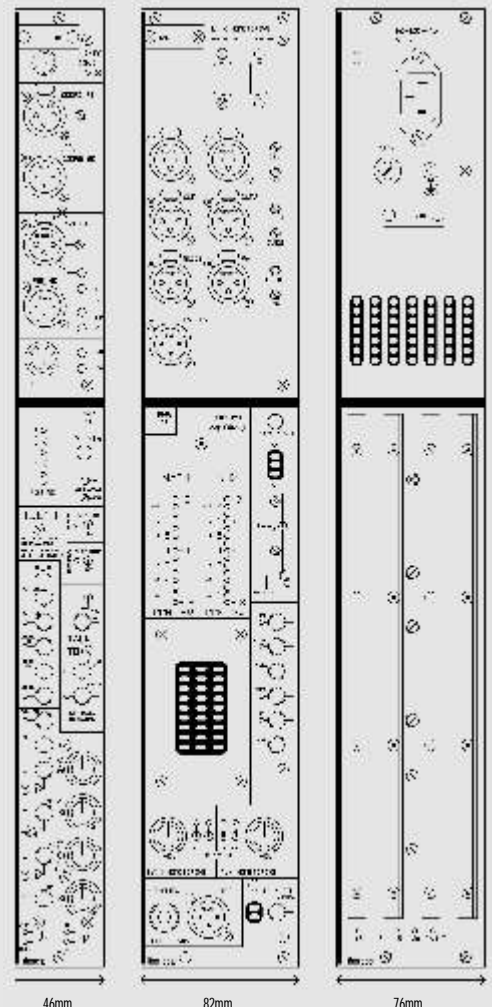

GS-OC33 Base Station

Input

The base station has an XLR socket for connection of an external microphone (phantom option), or a top panel microphone for engineer talkback.

Outputs/Talkback

The engineer has talkback controls for communicating with all the commentators together, the co-ordination circuit, or directly on the programme output. On the rear panel, there are direct pre-fade outputs of the 3 commentator inputs plus a mixed programme output of all commentator inputs - these are available on bantam jacks. Outputs for the co-ordination talkback circuit and programme output are on XLR. There are two line idents, one on the programme output, and one on the co-ordination circuit. The rear panel of the GS-OC33 module features a din connector with a bi-directional loop connection on the co-ordination circuit. This is for connection to an external talkback system.

Monitoring

The GS-OC33 has a very comprehensive monitoring function. The engineers 6.35mm headphone connection is on the monitoring module of the base station. There are two monitoring channels, the MAIN (left ear) and AUX (right ear). Each channel is level adjustable and can be monitored on headphones, switched to an internal speaker, or switched to an external speaker. The MAIN monitoring (blue buttons) is the commentators and programme audio, whilst the AUX (green buttons) is all general inputs and outputs. The MAIN and AUX monitors have independent 15 segment LED meters that are switchable between PPM and VU. There are several common inputs across all GS-OC33 channel modules that can be monitored: PA and GUIDE (that are presented on the GS-OC34), CUE1 and CUE2 (one of which is selected as a master non-mutable input on the GS-OC34), and IS1 and IS2 (one of which the engineers selects for routing to the international sound input on the GS-OC34). These shared common inputs are presented on a 9 pin D-type for linking to other GS-OC33 base stations. Each GS-OC33 channel module has a rear panel local GUIDE input on a bantam connection which will override the shared GUIDE input. There is also a rear panel insert point for the B mic on a bantam socket.



GS-OC34 Commentators' Box



GS-OC33 Base Station

Power Supply

The base station can contain 2 switch mode power supplies 100-250v AC for redundant operation. These include fault light indicators. The system can be used with a single power supply in smaller configurations if required.

Link

Each GS-OC34 links to an individual GS-OC33 module via a coaxial cable. Using suitable cable, the GS-OC34 can be up 500m away from the GS-OC33 module. The link carries bi-directional audio, data, and remote power for the GS-OC34 so omitting the need for any local power.

GS-OC34 Commentators' Box

Inputs

Each of the three commentators has a mic input on XLR with a selectable 12v phantom power where the centre commentator C position also has a selectable line input. There is an independent preset compressor/limiter per input.

Outputs/Talkback

Each commentator has 2 separate push buttons for 2 talkback circuits - one for the engineer at the base station and one for the external co-ordinator. The rear panel has a mixed programme output.

Monitoring

Each of the three commentators has a 6.35mm jack socket for headphones. There are 6 variable pots per commentator, 5 external sources, and 1 mix of the incoming commentators' audio sources. Each monitoring input can be switched between left/both/right channels of the headphones. Two of these sources, GUIDE and PA, are common across all connected GS-OC34 units connected to the same base station. There is a hidden seventh monitoring input that cannot be turned down and will enter the commentators' headphones at a fixed level. This is selected from one of two global external inputs on the base station, CUE1 or CUE2 - often a global director, as it will appear on every GS-OC34 connected to the base station.

Power Supply

The GS-OC34 is powered via the coax link to the GS-OC33 channel module.

Features



The GlenSound Digital Commentary GDC 6432 is a powerful high quality digital audio system. The system comprises the GDC 6432 dCCU (or dCCUx) Commentary Control Unit base station, and the GDC 6432 dCU/3 (or dCU/3S) commentators' box - they must always be a pair. The dCCU includes the free software, Java remote, mixer/router controller, and switch profile software.



Powerful and versatile digital commentary system with three linking options

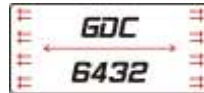

- Three commentator system with separate commentators' unit and commentary control unit
- Facilities for 3 commentators
- Digital link available as coaxial, copper Ethernet or fibre Ethernet
- Digital router internally - 64 inputs and 32 outputs
- Full remote control and communication via open internet and a web browser
- Internal digital resolution of 32 bits allows for the essential management of commentary audio peaks

Elevations

Front Panel

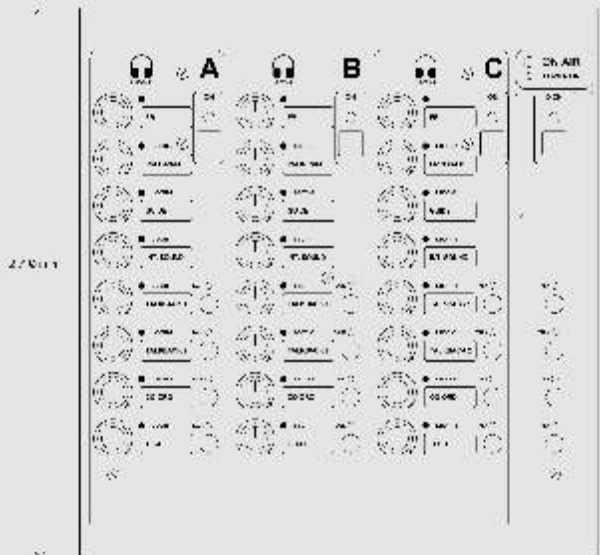

Side Panel



GDC-6432-dCCU Front Panel



Rear Panel



GDC-6432-dCCU Rear Panel



For a block diagram please visit www.glenSound.co.uk
For technical specifications please see page 36



GDC-6432 dCCU Digital Commentary Control Unit

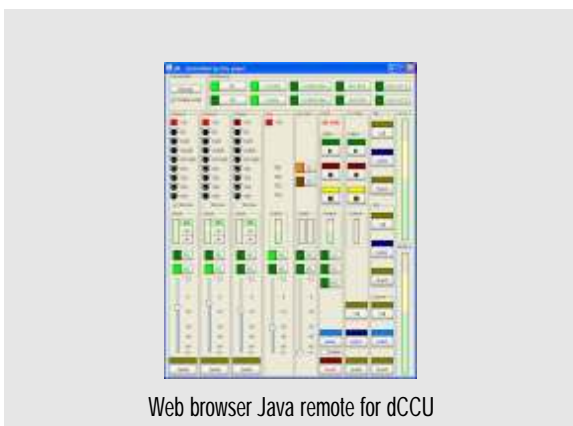

Web browser Java remote for dCCU

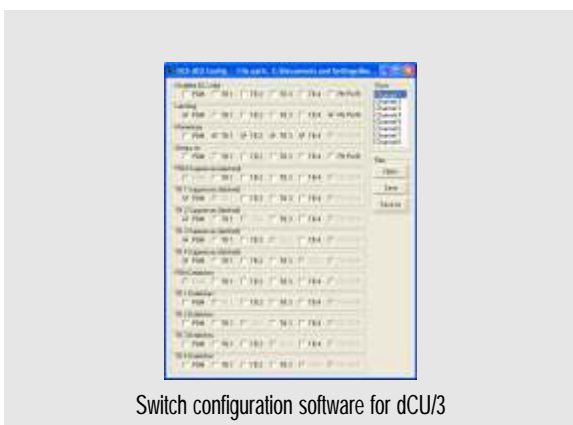

Switch configuration software for dCU/3

GDC 6432 dCCU - Digital Commentary Control

Inputs

There is a front panel mic and an XLR connection for an external mic with phantom power select and gain control.

Master Input/Output

As the GDC 6432 is a digital router, the inputs and outputs can be configured to suit any requirement. There are 16 inputs and 16 outputs; these are presented as 8 AES ins and outs as standard on 9 pin D-types (balanced or unbalanced). Analogue inputs and outputs can be added in combination to AES by replacing 1, 2, 4, 6 or 8 AES cards. Adding analogue I/O increases the number of 9 pin D-types on the rear panel.

Outputs/Talkback

The front panel has push buttons for direct talkback with each commentator individually and a global button for all commentators. In addition there are also push buttons for the other 3 talkback circuits. The engineer can also hold down two buttons to talk down the programme output if required. There are 2 digital line idents; the outputs can be routed as required but by default they are for the programme and co-ordination circuits. The line idents can contain 46 seconds of audio with any unused time being filled with tone.

Monitoring

The front panel has a 6.35mm jack socket for headphone monitoring - these two channels can be configured in the router. There are two pots for headphone level control; left ear and right ear. By default the programme output goes to the right ear, and the left ear is assigned via the monitoring section. The sources for monitoring are selected via a rotary encoder, with each push of the encoder adding the source to the left ear monitor mix.

Power

The dCCU has an internal switch mode power supply from 100-240v AC.

Link

The dCCU and dCU/3 can connect in three different ways, each carrying 8 channels of bi-directional audio at 24bit 48kHz:

- 1) A normal coaxial link will allow for up to 400m range and also power the d C U / 3 . This is still many engineers preferred link and using the GDC 6432 maintains high quality and a low noise floor.
- 2) Copper Ethernet allowing up 100m range and also power for the dCU/3. This is linked using a normal network cable on RJ45 connections.
- 3) Fibre Ethernet allows connections over many kilometres with local power required for the dCU/3. A pair of suitable SFP modules are required to interface between the GDC 6432 units when using fibre.

Web browser remote and more

The dCCU features 8 DC Loops. These can be used as input or output contact closures for interfacing with external intercom systems, or signalling mic open for example. The expansion port is used for linking multiple dCCU units together. Monitoring and talkback circuits are linked so one engineer needs only connect to 1 dCCU to be able to monitor or communicate on any system. The entire system can be controlled using the dCCUs internal web server and a web browser on any internet connected PC. The status of all pot positions and gain levels are available in real time and an engineer can remotely control any function: gain level, mix levels, or phantom power for example. If 2MB bandwidth is available in each direction, audio can be enabled, then using the sound card on the remotes PC, an engineer can talk to any commentator or talkback, and they can talk to him.

Features





GDC-6432 dCU/3 Digital Commentators' Unit

The world's most advanced commentary unit



GDC 6432 dCU/3 Digital Commentators' Unit

Inputs

There are four front panel XLR inputs: 3 of these with selectable 48v phantom power, and the fourth is line only. The fourth input is also paralleled with a 3.5mm jack socket. All inputs have a configurable, common compressor/limiter. Input on/off buttons can be configured as on/off or always on with cough/mute. The rear panel has auxiliary inputs that can be configured in the router to any output in any combination, as part of the digital router control. A single AES3 on XLR provides 2 digital inputs. Two XLRs provide two channels of balanced analogue audio inputs. Paralleled to these are 3 x 3.5mm jacks: a mono for each channel, and a stereo that is internally split left and right to the two channels.

Outputs/Talkback

The main three commentators have 6.35mm jack sockets for headphones. Each commentator has independent pushbuttons to four talkback circuits. These push buttons feature Config+ and can be configured individually to operate as required. The rear panel has two digital outputs on a single AES XLR connection. These are paralleled to the analogue outputs: two balanced outputs on XLR, two 3.5mm jack sockets, or a single stereo 3.5mm jack socket.

Monitoring

There are 8 pots per commentator for independent adjustment of monitoring levels. As these can be configured by the router, they could all be external sources or all generated internally. Standard configuration allows for 6 external sources, 1 engineer and 1 mix of all incoming commentators. Each input has soft switching between left/both/right ears with LED indication. The pots can be individually configured to go down to cut or just to dim.

Power

The dCU/3 is powered via the link to the dCCU using coaxial or CAT5 cable. If fibre is used as the link, the dCU/3 is powered via an external 48v DC power supply.



Units For Multi Commentators

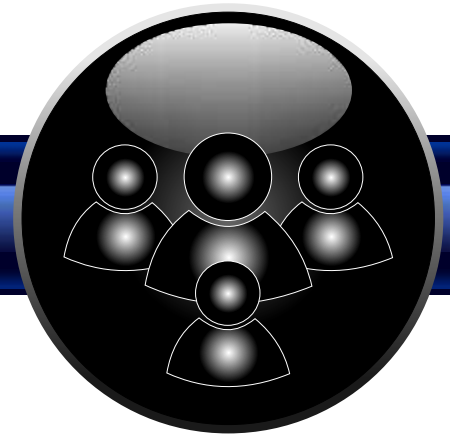

GS-GC21/19/22

Two part Cat 5 system with producers box

GS-CCU002/CU006

Two part multiwire system for high audio quality

GS-GX3

High quality modular portable outside broadcast mixer

Talent Box

The most powerful and advanced single unit commentary system available



A specialist CAT5 commentary system featuring up to 4 individual commentary units, a separate producer's unit, and producing two programme outputs.

This CAT 5 system is very popular in studios where having small, individual commentary boxes is an advantage. The two programme outputs also make it very useful when the same event may require two separate commentary outputs. For example, two separate programmes in different languages, or one programme for the 2D commentary and the other for the 3D commentary. The CAT5 link also provides a high audio quality level. A very versatile all round commentary system.

- Features up to 4 small, individual commentary units
- Optional single producer's unit
- CAT 5 cable links with 150m range
- 6 monitoring sources
- 4 talkback circuits
- Produces 2 separate programme outputs



Elevations

GS-GC19 Front Panel

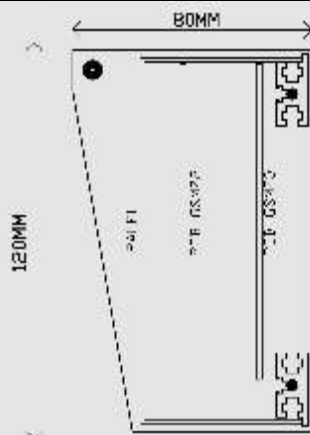
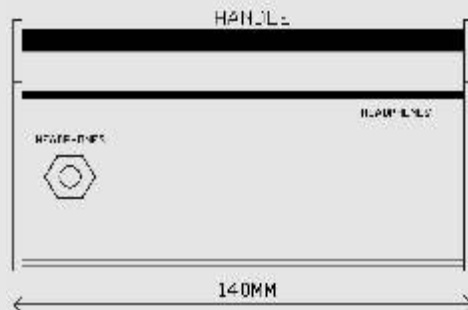
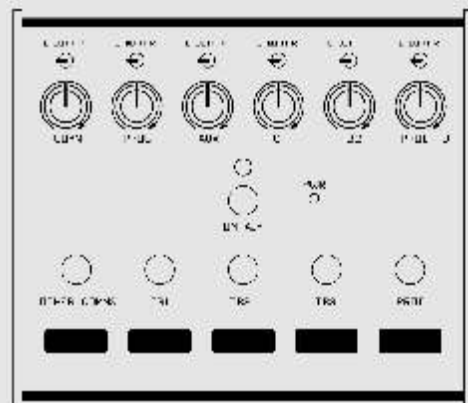

GS-GC19 Side Panel

GS-GC19 Rear Panel

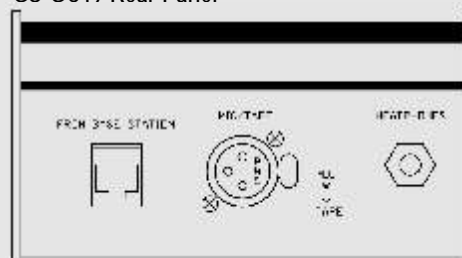

GS-GC22 Front Panel

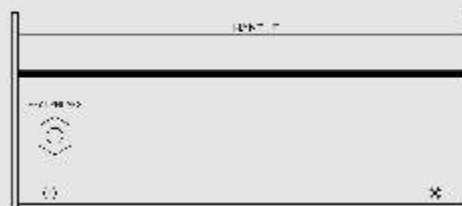
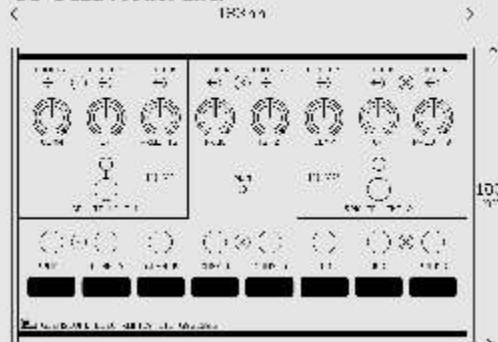

GS-GC19 Rear Panel

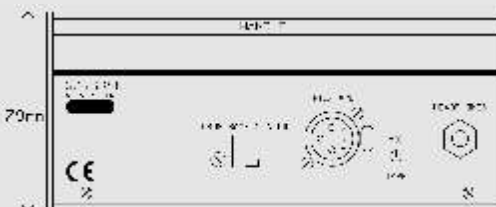

GS-GC21 Front Panel

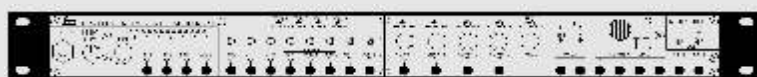

GS-GC21 Rear Panel

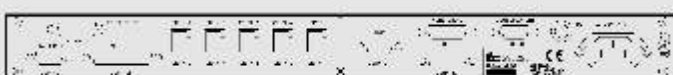



GS-GC21B Commentary Control Unit

GS-GC21B Commentary Control Unit

Inputs/Outputs/Talkback

There is a front panel microphone for engineer talkback. The engineer has access to pushbuttons for direct talkback to each individual commentator, talkback 2 and 3, and the 2 producer's circuits. There is a separate line ident for each of the 2 programme outputs. Each of the 4 commentators can be selected to either the programme 1 or programme 2 outputs. All outputs are on the rear panel are on D-type connectors with direct commentator pre-fades, master I/O and talkback, all on separate connectors.

Monitoring

The front panel features a 6.35mm jack socket for headphone monitoring where there are two pots for level adjust of the left ear and the right ear. Talkbacks are coloured red and are presented in the left ear, all other monitoring sources are coloured green and appear in the right ear. The monitoring outputs are also presented on a D-type connector on the rear of the unit. There is a 14 segment LED PPM meter.

Power

There is an internal switch mode power supply 100-250v AC.

Link

The remote unit links back to the GS-GC21B are all via CAT5. This link carries bi-directional audio information, data, and power, and has a maximum useable distance of 150m.

GS-GC22B Producers Unit

Inputs

A rear panel XLR is available for a single mic or line input with a small gain control. There are two separate top panel mic/on/off switches for talking to programme 1 or programme 2.

Outputs/Talkback

The producer has multiple talkback buttons which can be used to talk individually to both of the mixed programme outputs or for directly talking to each of the 4 commentators plus the other 2 talkback circuits. Two other producer-only talkback circuits are independent circuits but are typically split in use between programme 1 and programme 2.

Monitoring

In total, there are 8 variable pots for the monitoring of 8 individual sources, two of which are common audio sources for both programme outputs. Three sources are dedicated for the monitoring of each programme output where each source has left/both/right headphone switching. For headphone monitoring, a 6.35mm jack socket is located on the front and rear of the panel.

Power

This unit is powered from the GS-GC21B via the CAT5 connection.



GS-GC22B Producer's Unit

GS-GC19B Commentators' Unit

Inputs

A rear panel XLR is available for a single mic or line input with a small rear panel gain control. There is a top panel mic/on/off push button where the input features a preset compressor/limiter.

Outputs/Talkback

There are 3 push buttons for the 3 talkback circuits and additional pushbuttons for talkback to the other commentators or to the producer's box.

Monitoring

There are 6 variable pots for monitoring of 6 individual sources where each source has left/both/right headphone switching. For headphone monitoring, there is a 6.35mm jack socket on the front and rear panel.

Power

This unit is powered from the GS-GC21B via the CAT5 connection.



GS-GC19B Commentators' Unit

Features





Two part multiwire system for high audio quality

The GS-CCU002 and GS-CU006 commentators' system has a 3RU base station and up to 4 commentators boxes. The interconnection is via multicore cable and the system offers excellent audio quality.

- Up to 4 commentators each with individual commentary units
- 4 talkback circuits
- Superior audio quality
- Audio links using high quality and rugged DEF32 (Amphenol) connectors



Elevations

GS-CU006 Front Panel

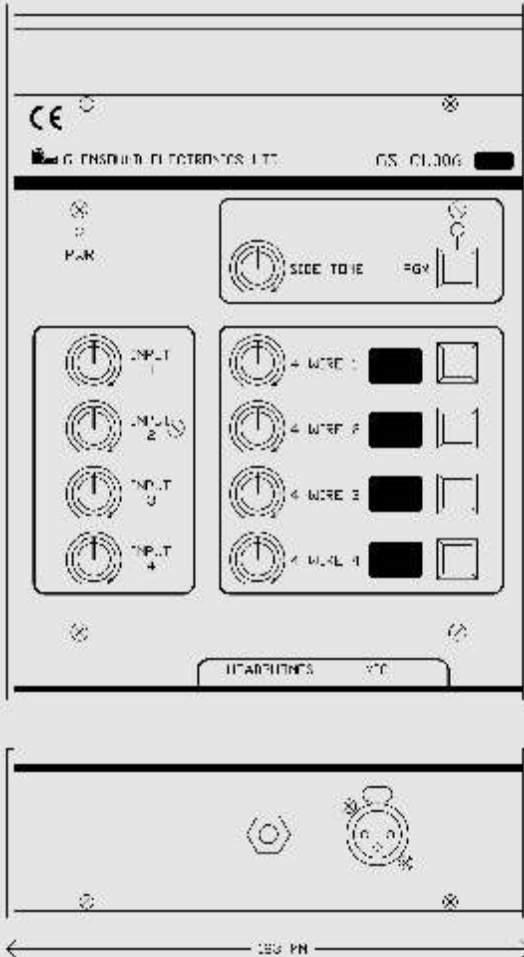

GS-CU006 Side Panel

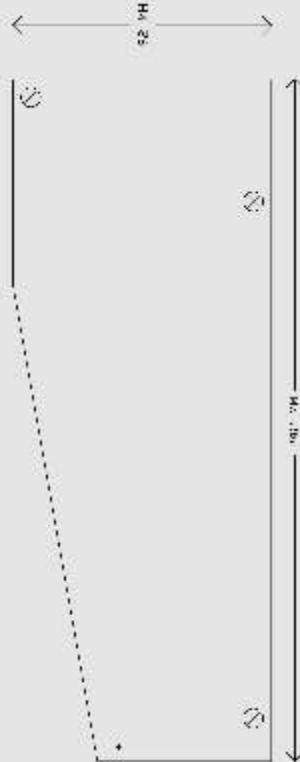

GS-CU006 Rear Panel

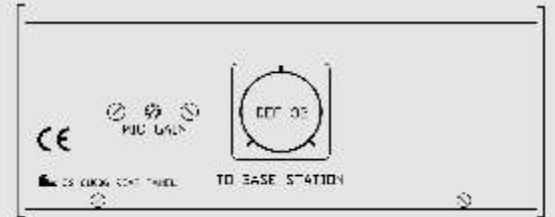

GS-CCU002 Front Panel

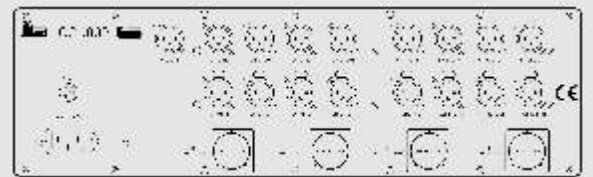

GS-CCU002 Rear Panel

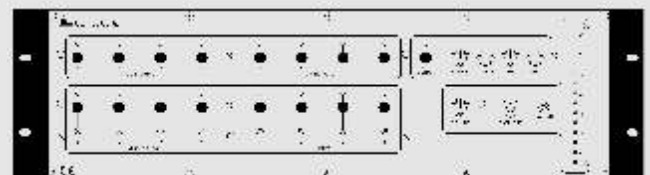



GS-CCU002 Base Station

GS-CCU002 Base Station

Outputs/Talkback

A master programme output is achieved via a mix from the 4 output mixer that has a single variable pot for each of the 4 commentators. This enables the engineer to set the master programme output mix level. The rear panel has individual XLRs for the programme mix of all commentators with a direct out of each individual commentator. There are also 4 x XLR outputs, 1 for each talkback circuit.

Monitoring

There is a front panel 6.35mm socket for headphone monitoring with an overall level pot. The following pushbuttons are available for individual monitoring (one at a time): an overall output mix, individually the 4 commentators, individually the 4 wire inputs or outputs, and then individually the four external inputs. There is a 28 segment LED PPM meter.

Power

The GS-CCU002 contains an internal switch mode power supply 90-240v AC.

Link

The GS-CCU002 and GSCU006s connect via multi-pin DEF32 (Amphenol) connectors. This connection carries high quality bi-directional audio, data, and power. The cables are generally quite short (around 3m long) as both parts of the system are used in the same location. These cables also offer high connection security.



DEF32 CONNECTORS



GS-CU006 Commentators' Unit

GS-CU006 Commentators Unit

Inputs

XLR mic input on the front panel with mic gain on the rear panel. There is a top panel pushbutton for mic on/off. The input features a preset compressor/limiter.

Outputs/Talkback

There are four pushbuttons for the four talkback circuits.

Monitoring

There is a front panel 6.35mm socket for headphone monitoring. There are 9 variable monitoring pots in total on the top panel; four are the 4 talkback circuit returns, 4 are additional external monitoring sources, and there is a single sidetone control.

Power

There are 4 x DEF32 (Amphenol) connectors out to the GS-CU006 commentary units which provide the power to each unit.

Four individual commentary boxes, multiple sources to monitor, flexible talkback, and high audio quality

Features



The GS-GX3 was designed as a hybrid between an outside broadcast mixer and a commentary unit. The commentator's connect their microphones and headphones directly to the GS-GX3 input channel where the engineer operating the desk controls their individual headphone mix, and can talk to any commentator individually.



High quality modular portable outside broadcast mixer

- Complete outside broadcast workstation
- Dedicated commentary facilities
- Headphone output on every mono input channel
- 4 monitoring sources on every mono channel
- Integrated talkback
- Line Ident
- Up to 16 commentator inputs if required
- Commentary output mix on vertical faders
- Optional producer's box

Elevations

GS-GX3 Channel Modules

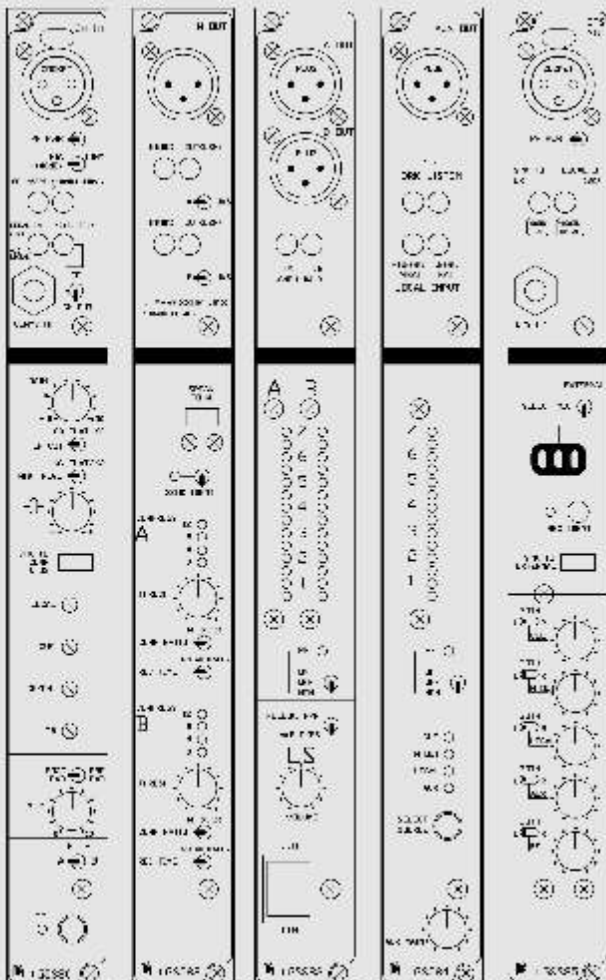

GS-GX3 Producers Box Top Panel

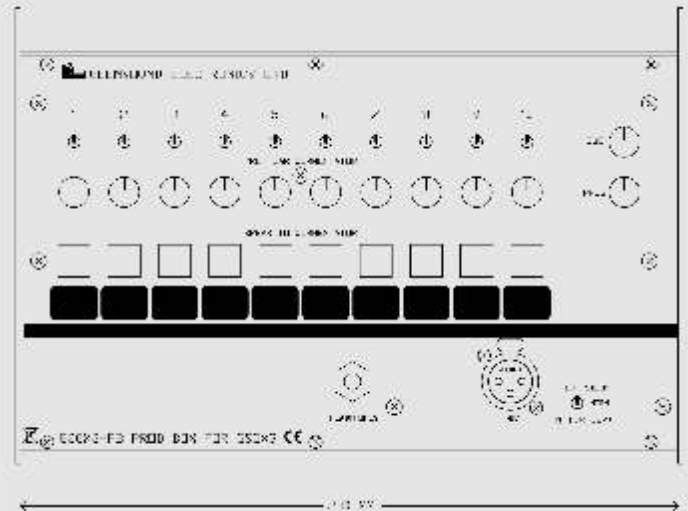

GS-GX3 Producers Box Side Panel

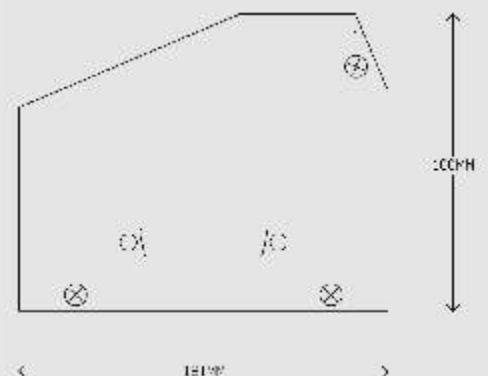

Modules

GS-GX3Fxx	Modular frame from 4-16 input channels wide
GS-GX3/MONO MKII	Mono/Commentator input channel
GS-GX3/STEREO	Stereo channel
GS-GX3/ISDN	ISDN channel
GS-GX3/HEAD	Operator's headphone & talkback channel
GS-GX3/HEAD MKII	Operator's headphone & talkback channel MKII
GS-GX3/AMO	Aux monitoring & output channel
GS-GX3/OUT	Main monitoring & output channel
GS-GX3/CMO MKII	Compressor & mono output channel MKII
GS-GX3/PROD	Producer's box

INPUTS

Mono/Commentator Input Channel

The analogue XLR input is mic/line switchable with selectable 48v phantom power. There is a top panel input gain with cut switch and fader.

Stereo Input Channel

There are 2 analogue inputs on 2 x XLR and 2 x phono with a preset compressor/limiter. There is a top panel input gain with cut switch and fader.

Operators Headphone & Talkback Channel (both versions)

There is an internal top panel mic or a rear panel external mic on XLR that offers selectable 48v phantom power which are used for engineer talkback.

Aux monitoring & output channel

There are unbalanced and balanced local inputs on individual bantam sockets.

ISDN Codec Channel

There is a bantam input for the top panel loudspeaker.

Compressor & mono output channel MKII

There are 2 x rear panel bantams for external (or over patched) inputs into the consoles compressors where each of them can be used separately. For example, the commentators can use one and international sound can use the other, ensuring the crowd cheering will not affect the level of the commentary audio.

OUTPUTS/TALKBACK

Mono/Commentator Input Channel

There is a pushbutton for talkback to the connected commentator (or line) and also an insert point on bantam jack sockets. The rear of the channel features individual channel outputs which can also be selected as a clean feed output (on bantam). The top panel has a variable pot for the pre or post fade aux send, a pan control, and an output fader.

Stereo Input Channel

The top panel has a variable pot for the pre or post fade aux send, a pan control, and an output fader.

ISDN Codec Channel

There are individual outputs of both of the G711/G722 ISDN channels on rear panel bantam

sockets, along with a single mono output of the programme mix (on bantam). The top panel has two talkback push buttons – one for each ISDN channel.

Operators Headphone & Talkback Channel (both versions)

There is a pushbutton for talkback to an external source (located via rear panel bantam output). The top panel includes the activation switch for the line ident.

Aux monitoring & output channel

The aux output is on a rear panel XLR. The 'listen' output for the cue bus is on a bantam.

Main monitoring & output channel

The main stereo programme outputs are on 2 x analogue rear panel XLRs. The level is set by the top panel master fader.

Compressor & mono output channel MKII

There are 2 x rear panel bantams for external (or over patched) outputs from the consoles compressors. There is a push button for the engineer to speak onto the mono output and a switch for sending the line ident to mono output.

MONITORING

Mono/Commentator Input Channel

The rear panel features a 6.35mm headphone socket and a bantam socket for connection of a local input. The top panel has 4 small variable pots for creating a headphone mix between the local input, cue, clean feed/programme mix, and talkback. There is a pushbutton for monitoring the channel in prefade. All mono input channels can be set to cut or dim the loudspeaker bus.

Stereo Input Channel

There is a pushbutton for monitoring the channel in prefade.

Operators Headphone & Talkback Channel MKI

There are 5 sources with variable pots to create the engineers monitoring mix – cue, mono output, local input, aux, and prefade. Each source has left/both/right headphone switching.

Operators Headphone & Talkback Channel MKII

There are 5 sources with variable pots to create the engineers monitoring mix – cue, mono output, local input, aux, prefade. Each source has a solo push button.

Aux monitoring & output channel

There is a single 14 segment LED PPM meter on the top panel with selectable sources. In addition, there is a master pot on the top panel for the adjusting the aux output level.

Main monitoring & output channel

There are 2 x 14 segment LED PPM meters on the top panel for master monitoring. A variable pot controls the loudspeaker output level and a speaker cut/dim control is present.

POWER

There is an internal switch mode power supply 100-250v AC and a 4 pin XLR connection for an external 12v DC battery.

PRODUCERS BOX

The producer's box connects to the GSGX3 via a 25 way 'D' cable. It provides facilities for a producer to listen to the inputs from 10 channels of the mixer plus the main output mix and the return cue. It also allows the producer to talk individually into the headphone feeds of the first 10 channels of the mixer. There is an XLR mic input with a 3 position gain switch and a 6.35mm headphone jack on the front panel.

Features



Link Talent Boxes for up to 30 commentators on a single programme, and share monitoring and talkback



TALENT BOX



The Talent Box is the next generation of single unit commentary where multiple Talent Box's can be linked to accommodate up to 30 commentators! CAT5 connections link the talkback, monitoring and programme output buses with multiple units by simply daisy chaining together if required. Glensound achieved this by developing the 'Current Mixing System' (CMBus) allowing the inputs on any individual system to be mixed into the common main programme, talkback and monitoring buses while maintaining low noise. Unlike traditional voltage mix techniques, the Glensound CMBus system is not susceptible to noise and interference that are prevalent in outside broadcast environments.

The talkback and monitoring inputs need only be connected to one unit in order for the CMBus to deliver their audio circuits to the relevant headphone feeds in all units. If duplicate monitoring inputs are connected on different boxes, the CMBus will mix them together enabling all commentators to monitor the source. A main programme output can be taken for any or all of the individual units. Direct outputs are not carried on the CMBus, although are available individually on each unit if required.

The CMBus utilises three standard RJ45 cables for linking two boxes together which are broken down in such a way that allows sets of sources to be isolated on individual boxes. This makes the Talent Box's CMBus system a truly versatile solution for multiple commentator applications.

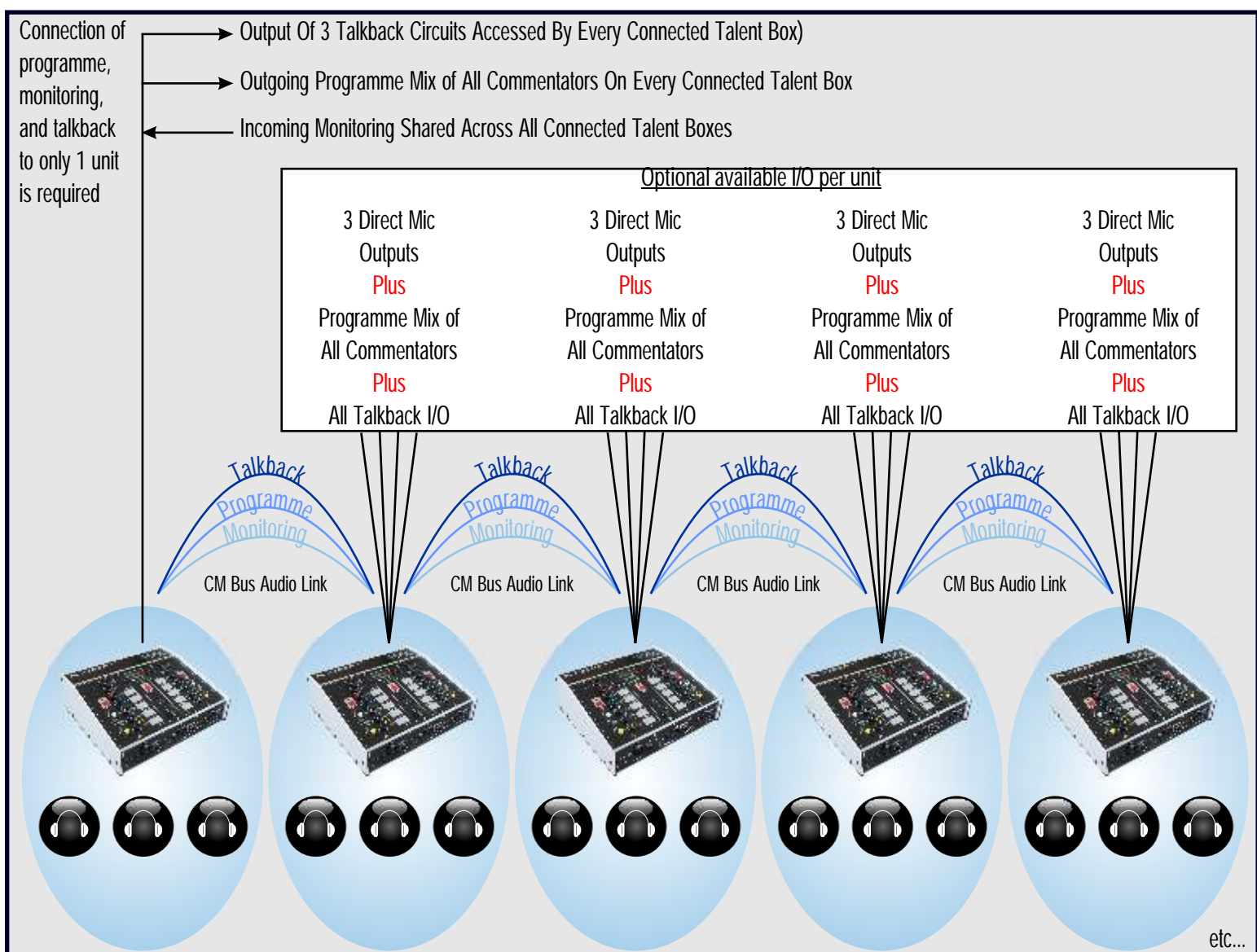

Headset and Mic Guide

The final decision of which pair of headphones, headset or microphone to purchase for use for commentary work is normally down to personal preference. There are particular headsets & mics that are very commonly found in commentary booths but, with perhaps the exception of the Coles 4104 microphone, there is no single device that outperforms all others in it's class.

Initial choices when selecting commentary mics, headphones & headsets

The first basic question that must be addressed; are you working in a quiet or noisy environment? Commentary boxes are generally used in noisy sports stadiums however they are also used in studios for 'off-tube' work and at naturally quiet sports environments such as a snooker or golf tournament.

In a noisy environment the 2 most fundamental points are the acoustical isolation normally provided by the ear pads around the headphone drivers, and the rejection of background noise by the microphone. Clearly, it is very important the commentators can hear talkback & programme circuits clearly and ensuring their voices are not drowned out due to excessive background noise. Another important decision is the extent of importance attached to aesthetics. As more and more broadcasters offer their viewers the ability to see the commentator either via televised pre-match discussion or live web cam views during the event, the look of the equipment can start to matter.

It is likely the final choice of device will address the preference of 'to hold' or 'not to hold!' Many commentators like having both hands free during their work as it generally makes access to information that they may need easier. If they are using a hand held microphone they can be restricted in movement and therefore as a general rule, commentators opt for headsets rather than a separate microphone and headphone.

Technical considerations

- Headphones have an impedance rating. It is important the headphones that are used have a rating that matches the rating of the equipment they are connected to. In very broad terms, professional headphones have higher impedances than 'domestic' versions. Most domestic headphones only have impedances of 16 or 32 ohms, whereas popular broadcast headphones such as the Sennheiser HMD25 or 26 have an impedance of 600 ohms. The electronic circuit required to correctly drive these different impedances are not the same and although you can connect a low impedance headset to a drive circuit designed for use with high impedances (or vice versa), the end result can be very poor.
- Does the microphone need phantom power and how much? Clearly, if the preference is for an electret/ condenser microphone that requires phantom power, the commentary box must be able to provide this. Did you know that by far the vast majority of broadcast headsets require 5 – 15volts of phantom power?
- Microphone pick up pattern matters a great deal in a noisy environment. If a general purpose microphone such as the ubiquitous Shure SM58 is used, the results are likely to be very poor as the microphone may not be designed for such an application. Check the specifications of your favoured mic and ensure it has been designed for commentary work.

A few commonly used devices



Coles 4104

This was originally designed by the BBC and has for many years, been manufactured by Coles Electroacoustics. It has developed a reputation as being the only hand held microphone suitable for use in very noisy environments and is favoured by many major broadcasters. It is a ribbon microphone which has a bi-directional polar response meaning it picks up very little ambient noise. Its design means that placement in respect of the commentators mouth is import and as such, there are locating bars at the top of the microphone to aid correct positioning. The output level is fairly low so the commentary box needs to have in excess of 61dB of mic gain available.



Beyerdynamic DT190

An older design of headset that has been popular due its intense 'ruggability' and the relative low cost & ease of repair. The headphones offer great acoustic isolation and the microphone works well, however, it is a little low on bandwidth (at the top end) for some peoples' tastes. The headsets' 'ruggability' is one of its major plus points but also one of its weaknesses as it is big and bulky.



Beyerdynamic DT297

We have many of these in our own hire stock. We opted for them as we believe they offer a good balance between cost & performance. The headphones fit nicely over the ears, provide good isolation and the microphone capsule (condenser (needs 12V phantom) also performs well. One big downside is the gooseneck style mic arm as it allows the microphone capsule to be rotated through 360 degrees and thus a commentator can fiddle and have the capsule facing 180 degrees away from their mouth.



Sennheiser HMD26

The HMD26 is a relatively new design and it replaces the hugely popular HMD25. In theory, the HMD26 is an updated version of the HMD25 and it continues to provide the facilities that were popular on its predecessor - the main plus points being size, weight, and acoustic performance. It has surprisingly small headphones which, although do not enclose the whole of the ear, do provide excellent isolation. Due to requests from customers, we have purchased many of these headsets for our hire stock. They are expensive and spares are also very pricey, although very popular with users. The older HMD25 was not as hard wearing as engineers would like and spare part pricing can become an issue.

Specifications

		GS-CU004	GS-CU008	GS-CU010	GS-VC1	GS-BC2
MICROPHONE INPUTS GENERAL	QTY Mic/Line inputs on XLR	1				
	QTY Mic inputs on XLR		1	1	2	2
	Qty unbalanced 3.5mm inputs					
	Mic ON switch configuration	User Programmable	User Programmable	User Programmable	Fixed	Fixed
MICROPHONE INPUTS TECHNICAL	Mic input gain range	44 to 67dB	42 to 66dB	43 to 65dB	Fixed @ 53dB Can be factory changed	Fixed @ 54dB Can be factory changed
	Phantom power input gain range	36 to 59dB	31 to 56dB	33 to 55dB		Fixed @ -44dB Can be factory changed
	Line input gain range	1 to 24dB				
	Headroom (No dB above line up before clipping)	32dB	39dB	39dB	34dB	45dB
	Input impedance	>=1K5	1K5	1K1	1K5	1K5
	Compressor/ Limiter (dB IN : dB OUT)	Fixed 3:1 ratio (approx)	Selectable complex ratio 2:1 to 5:1	complex ratio 2:1 to 5:1	complex ratio 10:7 to 5:1	complex ratio 10:7 to 5:1
	Phantom Power Voltage	12V (P12L)	48V	12V (P12L)	12V (internal link)	12V (P12L)
	Band Pass Filter -3dB Points Filters are 12dB per octave	30Hz & 24kHz	30Hz & 20kHz		20Hz & 24kHz	30Hz & 20kHz
PROGRAMME OUTPUTS GENERAL	AES digital outputs					
	QTY mixed programme outputs					GS-BC2 = 2 GS-BC2A = 1
	QTY direct mic outputs	1	1	1	2 (1 for each input)	GS-BC2A = 1
	Passive loop through outputs					
	Local record output					
PROGRAMME OUTPUTS TECHNICAL	Output Balancing	Transformer	Transformer	Transformer	Electronic	Electronic
	Output Impedance	50 Ohms	50 Ohms	50 Ohms	50 Ohms	50 Ohms
	Equivalent Input Noise (22-22kHz RMS gain @ max) input terminated 300 ohms	119dBu	121dBu	124dBu	125dBu	118dBu
	Frequency Response 50Hz to 20kHz	<-1dBu		<-1dBu	-3dB (30Hz to 20kHz)	-3dB (30Hz to 20kHz)
	Maximum output level	+8.7dBu	+18dBu (limiter off) +12.5dBu (limiter on)	+10.5dBu	+12.5dBu	+14.5dBu
	THD + NOISE (50Hz to 20kHz) @ +8dBu	<0.25%	<0.2%	<0.2%	<0.2%	<0.2%
	Selectable -20dB output level (provides extra 20 dB headroom)		-10dB out switch			
TALKBACK OUTPUTS	AES digital outputs					
	QTY talkback outputs	1	0 to X depending on model ordered	1 on CU10 and 5 on CU10A	2 (1 for each commentator)	2
	Output Balancing	Transformer	Transformer	Transformer CU10 and Electronic on CU10A	Electronic	Electronic
	Adjustable Output Level					
	Internal TB between commentators					Spotter function allows Mic 2 to talk to Comm 1
	Talkback switch operation	User Programmable	User Programmable	User Programmable	Fixed	Fixed
HEADPHONE CIRCUITS	QTY headphone amplifiers	1	1	1	2	2
	QTY 6.35mm outputs	1	1	1	2	2
	QTY external inputs	2	1 + X depending on model ordered	2	4 (2 shared 1 unique for each commentator)	4
	AES digital inputs available					
	Input balancing	Electronic	Transformer	Electronic		Transformer
	Input impedance	>80kOhms	=>15kohms	>100kOhms	>30kOhms	>20kOhms
	Sidetone own mic to own headphone	Fixed @ -10dBu	Front Panel Full Size Pot	Front Panel Switch @ Fixed -6Bu		Front Panel Full Size Pot
	Gain range of headphone pots (with end stops on)	-20 to +10dBu	-20 to +10dBu	-20 to +10dBu	-20 to +6dBu	-20 to +10dBu
	Endstops (to prevent complete attenuation of signal)	Fixed on (can be factory removed)	Internal solder links to turn endstop off	Fixed on (can be factory removed)	Fixed on (can be factory removed)	Fixed on (can be factory removed)
	Headphone impedance	200 – 2000 Ohms	200 – 2000 Ohms	200 – 2000 Ohms	200 – 2000 Ohms	200 – 2000 Ohms
	Left/Both/Right source routing	Yes	Yes	Yes	Separate pots for L/R ears	
	Max output level (into 600 Ohms)	+18dB	+18dB	+18dB	+18dB	+18dB
PPM	QTY LEDs	4	8	4		
	dB per LED + (nominal range)	6 (-12 to +6)	4 (-16 to +12)	6 (-12 to +6)		
CONNECTIVITY	GPIO		Optional		Optional	Optional
	Link					
PHYSICAL/ POWERING/ OTHER	Size W x D x H in mm	153 x 103 x 43	160 x 222 x 92 then + 31mm per extra TB	94 x 110 x 100	203 x 228 x 92	247 x 247 x 109
	Weight Kg	0.355Kg inc battery	1.4Kg then + 0.25Kg per extra TB	0.88Kg	1.78Kg	
	AC mains voltage range	100 – 240VAC 50/60Hz			100 – 240VAC 50/60Hz	100 – 240VAC 50/60Hz
	Other Power Input	12 to 20 V	10 – 18Volts 4 pin XLR	12 to 20 V		
	OTHER	Powered by 1 x PP3			Powered by 4 x AA	Internal rechargables for backup

		EXPRESS BOX	GS-CU001	TALENT BOX	GSGX3
MICROPHONE INPUTS GENERAL	QTY Mic/Line inputs on XLR		3	3	Boxes can be linked to up QTY
	QTY Mic inputs on XLR	2			
	Qty unbalanced 3.5mm inputs			1	
	Mic ON switch configuration	User Programmable	Config+	Config+	Fader
MICROPHONE INPUTS TECHNICAL	Mic input gain range	tbc	50 to 70dB	50 to 70dB	Remote control via web page
	Phantom power input gain range	tbc	25 to 45dB	25 to 45dB	
	Line input gain range		-10 to +10dB	-10 to +10dB	
	Headroom (No dB above line up before clipping)	tbc	30dB with limiter (50dB with -20 O/P)	tbc	36dB
	Input impedance	1K5	1K1	tbc	
	Compressor/ Limiter	tbc	Very complex ratio 10:4, 10:7, 10:3 & 4:2.5	Digitally controled	Fully featured adjustable module(s)
	Phantom Power Voltage	48V	12V Standard 48V No cost option	12V & 48V	48V
PROGRAMME OUTPUTS GENERAL	AES digital outputs			Optional (internal electronics are digital)	
	QTY mixed programme outputs	1	1	2	3 (A + B and Mono)
	QTY direct mic outputs	2	3	3	Up to 16
	Passive loop through outputs		On GS-CU001E		
	Local record output		On 3.5mm jack	On 3.5mm jack	
PROGRAMME OUTPUTS TECHNICAL	Output Balancing	Electronic	Electronic & transformer versions available	Electronic & transformer versions available	Mono – Transformer All other – Electronic
	Output Impedance	50 Ohms	50 Ohms	50 Ohms	50 Ohms
	Equivalent Input Noise (22-22kHz RMS gain @ max) input terminated 300ohms	tbc	126dBu	tbc	125dBu
	Frequency Response 50Hz to 20kHz	tbc	<-1dB (40Hz to 16kHz) Filter off	tbc	-1dB 25Hz to 20kHz
	Maximum output level	tbc	+20dBu (limiter off) +11dBu (limiter on)	tbc	+25dB
	THD + NOISE (50Hz to 20kHz) @ + 8dBu	tbc	<0.2%	tbc	<0.1%
TALKBACK OUTPUTS	Selectable -20dB output level (provides extra 20 dB headroom)		Yes	Yes	
	AES digital outputs			Optional (internal electronics are digital)	
	QTY talkback outputs	2	3	3	
	Output Balancing	Electronic	Electronic & transformer versions available	Electronic & transformer versions available	
	Adjustable Output Level			Yes	
	Internal TB between commentators		Versions D, E, L & M		
HEADPHONE CIRCUITS	Talkback switch operation	User Programmable	Config+	Config+	
	QTY headphone amplifiers	2	2	3	up to 17
	QTY 6.35mm outputs	2	4	3	up to 17
	QTY external inputs	4	5 (9 on versions E, G, L, M)	5 three with audio present indication	2 + 1 per Channel
	AES digital inputs available			Optional (internal electronics are digital)	
	Input balancing	Electronic	Electronic & transformer versions available	Electronic & transformer versions available	Electronic
	Input impedance	tbc		tbc	=>15kohms
	Sidetone own mic to own headphone	Front Panel Full Size Pot	Yes see brochure	Front Panel Full Size Pot	Selectable
	Gain range of headphone pots (with end stops on)	-20 to +10dBu	-20 to +10dBu	-20 to +10dBu	-60 to +10dBu
	Endstops (to prevent complete attenuation of signal)	Internal solder links to turn endstop on	Internal solder links to turn endstop on	Digitally set by menu	
	Headphone impedance	100 – 2000 Ohms	100 – 2000 Ohms	100 – 2000 Ohms	100 – 2000 Ohms
Left/Both/Right source routing		Yes	Yes digitally controlled		
PPM	Max output level (into 600 Ohms)		+19dBu	tbc	+18dB
	QTY LEDs	7	7	7	14
CONNECTIVITY	dB per LED + (range)	4 (-12 to +12)	4 (-12 to +12)	4 (-12 to +12)	2 (-14 to +12)
	GPIO		Optional	Yes configurable	
PHYSICAL/ POWERING/ OTHER	Link			CM bus to join up 10 comms coxes	External Producers box
	Size W x D x H in mm	220 x 250 x 95	Version B 277 x 266 x 105		150 + 30mm per CH x 380 x 150
	Weight Kg	1.4Kg	Version B all transformers 2.96Kg		
	AC mains voltage range	100 – 240VAC 50/60Hz	100 – 240VAC 50/60Hz		100 – 240VAC 50/60Hz
	DC Power Input		9 – 18Volts 4 pin XLR		9 – 18Volts 4 pin XLR
OTHER			Line ident & setup tone	Line ident & ISDN	

		GS-OC26/24	GS-OC33/34 (1 channel)	GDC-6432	GS-GC21/19/22	GS-CCU002/CU006
MICROPHONE INPUTS GENERAL	QTY Mic/Line inputs on XLR	1	1	1 + 2	4 + Producer	
	QTY Mic inputs on XLR	2	2	3		4
	Qty unbalanced 3.5mm inputs			3 (2 on rear)		
	Mic ON switch configuration	Fixed	Fixed	Config+	Fixed	Fixed
MICROPHONE INPUTS TECHNICAL	Mic input gain range	47 to 63 automatics or fixed @ 57dB	Switched 49 or 59dB	10 to 65dB in 1dB steps	52 to 66dB	42 to 70dB
	Phantom power input gain range	34 to 51 automatics or fixed @ 44dB	Switched 35 or 45dB	10 to 65dB in 1dB steps		
	Line input gain range	-8 to +8 automatics or fixed @ 0dB	Switched -10 or 0dB	0dB	9 to 5dB	
	Headroom (No dB above line up before clipping)	38dB	30dB above maximum gain	36dB (analogue equivalent)	35dB	40dB
	Input impedance	1K2 Mic >50K Line	1K2 Mic >50K Line	1K2 Mic >50K Line	1K2	1K to 1K5
	Compressor/ Limiter (dB IN : dB OUT)	Complex micro controlled	Complex	Digital & User Configurable	Threshold +5dB (4:1 to 5:1)	Threshold +3dB (4:1)
	Phantom Power Voltage	12V	12V	48V		
	Band Pass Filter -3dB Points Filters are 12dB per octave	25Hz & 12kHz	50Hz & 12kHz		45Hz & 16kHz 12dB/ Octave	40Hz & 15kHz 12dB/ Octave
PROGRAMME OUTPUTS GENERAL	AES digital outputs			Maximum 16 @ 48kHz		
	QTY mixed programme outputs	1	1	Configurable 0 – 16	2-Comms can be routed to either or both mixes	1
	QTY direct mic outputs	3	3	Configurable 0 – 16	4	4
	Passive loop through outputs					
	Local record output		PGM out on GSOC34	Configurable		
PROGRAMME OUTPUTS TECHNICAL	Output Balancing	Electronic	Transformer	AES – Transformer Analogue – Electronic	Electronic	Electronic
	Output Impedance	50-60 ohms	<65 ohms	AES – 110 Ohms Analogue 50 – 60 ohms	50 Ohms	50 Ohms
	Equivalent Input Noise (22-22kHz RMS gain @ max) input terminated 300 ohms	120dBu	113dBu	125dBu	119dBu	124dBu
	Frequency Response 50Hz to 20kHz	+1 -2dB 40Hz to 11kHz	+/- 2dB 40Hz to 10kHz	+/- 1dB 40Hz to 22kHz	-1dB 45Hz to 16kHz	-1dB 40Hz to 15kHz
	Maximum output level	>+12dBu	>+12dBu	0dBFS (+18dBu)	+16dBu	
	THD + NOISE (50Hz to 20kHz) @ +8dBu	<0.4% 300Hz to 3kHz	0.3% @ 1kHz	0.05%	<0.25%	<0.35%
	Selectable -20dB output level (provides extra 20 dB headroom)		Preset pot -9 to +6dBu	Configurable		
TALKBACK OUTPUTS	AES digital outputs			Maximum 16 @ 48kHz		
	QTY talkback outputs	1	1 + 1 internal	Maximum 16 analogue	3(2) + 3 internal	4
	Output Balancing	Electronic	Electronic	AES – Transformer Analogue – Electronic	Electronic	Electronic
	Adjustable Output Level		Preset pot -9 to +6dBu	Configurable		
	Internal TB between commentators	Yes via Coord	Yes via Coord	Configurable	Yes	
	Talkback switch operation	Fixed	Fixed	Config+	Fixed	Fixed
HEADPHONE CIRCUITS	QTY headphone amplifiers	3	3	6	4 + Producer	4
	QTY 6.35mm outputs	3	3	3	8 + Producer	4
	QTY external inputs		8 (only 6 routed to h'phones)	External up to 16 Internal up to 48	8 (6 to any comm)	8
	AES digital inputs available			Up to 16		
	Input balancing	Electronic	Electronic	AES – Transformer Analogue – Electronic	Electronic	Transformer
	Input impedance	>50kohms	>50kohms	AES – 110 Ohms Analogue >50kohms	>50kohms	>15kohms
	Sidetone own mic to own headphone	Via PGM Mix circuit	Via PGM Mix circuit	Configurable	Via PGM Mix circuit	Via PGM Mix circuit
	Gain range of headphone pots (with end stops on)	-20 to +10dBu	-20 to +10dBu	Configurable	-20 to +9dBu	-20 to +10dBu
	Endstops (to prevent complete attenuation of signal)	Internal solder links to turn endstop off	Internal solder links to turn endstop off	Configurable	Fixed on (can be factory removed)	Internal solder links to turn endstop off
	Headphone impedance	100 – 2000 ohms	100 – 2000 ohms	100 – 2000 ohms	100 – 2000 ohms	100 – 2000 ohms
	Left/Both/Right source routing	Yes	Yes	Configurable	Yes	
	Max output level (into 600 Ohms)	+18dB	+18dB	+18dB		+18dB
PPM	QTY LEDs	14	8 on channel 15 on main	8 Channel PF 2 x 14 Main Monitors	14	28
	dB per LED + (nominal range)	2 (-14 to +12)	CH is 4 (-16 to +12) MAIN is 2 (-14 to +14)	Configurable	2 (-14 to +12)	1 (-14 to +13)
CONNECTIVITY	GPIO			8 Configurable		
	Link	COAX Analogue time division multiplex	COAX Improved analogue time division multiplex	Digital 24bit Coax/ Ethernet	Bi-directional analogue audio, remote data mix	Multewire analogue on DEF32 (MIL) Connectors
PHYSICAL/ POWERING/ OTHER	Size W x D x H in mm	GSOC24 235 x 227 x 91 GSOC26 1RU 290mm	GSOC34 235 x 235 x 90	dCU 259 x 279 x 108 dCCU 1RU 272mm	GSGC19 140 x 120 x 80 GSGC21 1RU 285mm	GSCU006 183 x 242 x 92 GSCCU002 3RU 305mm
	Weight Kg	GSOC24 2.1Kg	GSOC34 2.1Kg	DCU 2.1Kg	GSGC19 0.66Kg	GSCU006 1.5Kg
	AC mains voltage range	110 – 240VAC 47-63 Hz	100 – 250VAC 47-63 Hz	100 – 240VAC 50/60Hz	100 – 240VAC 50/60Hz	90 – 240VAC 50/60Hz
	DC Power Input	Box powered by base station over COAX	Box powered by base station over COAX	Box powered by base station fully POE safe	Boxes powered by base station over CAT5	Boxes powered by base station over DEF32
	OTHER	Line ident & setup tone	Line ident & setup tone PPM is PPM / VU	It can't make tea but does EVERYTHING else!	Line ident & setup tone	

Glen sounds Real World Approach to Technical Specification

The measurement of technical specifications for broadcast (and even more so for 'pro audio') is anything but standard. Specifications can be very easily manipulated to appear considerably better than they are when the equipment is used for its intended purpose. Here at Glen sound, we have always taken what we consider to be a real world approach to our specifications where we try to provide information to our customers that is accurate and practical for every day situations. When conducting a quick comparison of Glen sound specifications to those of other manufacturers, their products may at first appear favourable, which in turn would lead the unsuspecting purchaser to assume that alternate equipment might perform better.....however this is rarely the case.

The purpose of these notes therefore, is to try to explain in simple terms how we measure a couple of our specifications and how we could mislead you if we wanted too!

Equivalent Input Noise (E.I.N.)

This measurement is provided to indicate how good (quiet) the audio electronic circuits within the equipment are. It is often specified in dB but should actually be specified as dBu or dBv. The aim for us manufacturers is to design equipment with the highest figure of E.I.N. possible. A genuine E.I.N. figure of -115 to -120dBu is good, -120 to -125dBu is very good and anything over -126dBu is pretty exceptional (when measured at 20 deg C for 20Hz to 22kHz and with a mic impedance of 300 ohms). As with most things in physics, there are actual maximum possible figures that are achievable, in the case of E.I.N. this maximum is attributed to 'Johnson noise'. Johnson noise is a calculation which takes into account the temperature, audio bandwidth and the resistance (in this case of the microphone attached to the circuit) and a constant figure called Boltzmann which is $1.3806504 \times 10^{-23}$. If a calculation is performed for a temperature of 20 deg C, a bandwidth of 21980 Hz (20Hz to 22kHz) and a resistance of 300 ohms, the absolute maximum theoretical E.I.N. is -127.49dBu is found. If the same calculation is conducted but using a resistance of 150 ohms, the absolute maximum increases to -130.5dBu.

Our spec sheets provide E.I.N. figures calculated on resistances of 300 ohmswhy?..... if you check the specification of a Sennheiser HMD26 or Beyerdynamic DT297 microphone (which are by far the most likely ones that will be used) you will find their mic capsule impedance is 300 ohms NOT 150 ohms. If we provided the specification measured at 150 ohms it may make our headline figure look better however, the equipment would not achieve the spec when connected in a real world situation.

E.I.N. figures can also be manipulated by reducing the bandwidth or changing the temperature value, therefore to be useful to understand the importance of as many of these parameters as possible when comparing figures.

Total Harmonic Distortion (THD) + Noise

This is another classic measurement that can easily be distorted (no pun intended) to provide meaningless figures. THD + NOISE provides a measurement of the distortion and noise of an output signal in relation to the input signal. Firstly, to compare any two measurements the frequency and amplitude of the signal must be known. Due to the non-linearity of electronic components, the measurement will vary greatly depending on the frequency that it is taken at. It is quite common to measure THD + NOISE at a single frequency, often at 1kHz (because this normally provides a very good result!). In 'Real World' applications, the commentators' mic amp will never be used at just 1kHz, thus, the THD + Noise figures across a much larger range will need to be known. In our opinion, the optimum figure required is across 50Hz to 20kHz as this is a much more realistic acoustic range that will be worked over.

Frequency Response in Commentary Boxes

In theory, the frequency response of equipment should be a relatively standard measurement and on the face of it, it is. Frequency response is often measured from 50Hz to 20kHz and for most equipment the flatter the response, in theory, the better the equipment. Therefore, in theory, something with frequency response of +/- 0.5dB across 50Hz to 20kHz is quite acceptable (and from a manufacturer's point of view not hugely challenging to achieve). However, the problem comes with the fact that in commentary circuits you really don't want a dead flat signal!.....why not?.....because you will be dealing with harsh environments, long cable runs and lots of unwanted noise (both acoustic and electronic (RF & magnetic induction)). The challenge is to keep any noise apart from the commentators voice out of the signal chain as much as possible. To alleviate unwanted out of band noise, we use 'band pass filters' which are electronic circuits that remove noise outside their parameters. In general, we design these filters to start rolling off the audio at about 50/60Hz and 19kHz. The filters we design start a gentle roll off and then increase to a steep 12dB per octave. Due to these filters (which are a good thing), the frequency response figures in our technical specifications will not appear flat!

You can review our units technical specifications with confidence as a true reflection of how they perform. If you have any questions about our specifications and how they are calculated, please contact me at any time. Thank you for using and trusting Glen sound commentary equipment for over 46 years, and making us the world leader.

Gavin Davis, Managing Director



www.glen sound.co.uk



Some of the questions that you had about commentary systems but were afraid to ask!

- Question 1** *What type of commentary system do I need for interviewing?*
A truly portable unit for interviewing and roaming is the belt pack GS-CU004. It is battery powered, clips on your belt and provides you with a talkback circuit.
- Question 2** *Which system is best suited to off tube work?*
Any of our desk top or rack mount systems can perform this. The most frequently used is the GS-CU001B which is a great all rounder.
- Question 3** *We carry lots of coaxial cable on our truck, and often we are a long way out from the commentary area. Which of your systems gives the best range between commentators' box and base station?*
Our workhouse unit in this environment is the GS-OC24 and GS-OC26 system. The units can be up to 500m apart. If you need more than this, the Glensound Digital Commentary GDC6432 can use fibre as a link and will give you many kilometres of range.
- Question 4** *I know that the analogue coaxial systems do have a certain amount of noise introduced on the link. If I want a two part system, but want to keep the audio as high quality as possible, what are my options?*
You would need the analogue systems that use real audio along multi-wire links. This would be the GS-GC19/20/21 system, or the GS-CCU02/CU006 systems. You could also use the GDC 6432 digital system. This will maintain 24 bit 48kHz audio even on a 400m coaxial link.
- Question 5** *Commentators are not always the most technical or people (we chose our words carefully!). Is there anything I can do to remote control their commentary box?*
The Glensound Digital Commentary GDC6432 offers complete remote control of the entire system from any internet connected PC just using a web browser interface. This includes remote control of mic gain, phantom power and even the output mix. On the Talent Box you also get network remote control of mic gains.
- Question 6** *How important is the microphone gain level range?*
The gain range of the mic input must be wide enough to adequately adjust for the input level of the microphone being used. On some units there are switches to adjust the gain range, but most will accommodate the normal range of dynamic and condenser microphones. Any unit can be preset to required gain ranges free of charge. Just let us know what mic you intend to use.
- Question 7** *Should I be worried about headroom figures?*
In short, YES! This is one of the most important aspects of any commentary unit. A commentary unit must have headroom of at least 32dB. This ensures that peaks can be accommodated without clipping on the outputs. If you do not have headroom of at least 32dB you do not really have a proper commentary unit, and an excited commentator shouting when a goal goes in may well clip.
- Question 8** *How many commentator positions are usually required?*
The majority of events usually have 2 - the main and co-commentator. A third is also quite popular, either as a sports specialist (an ex player for example), or for a producer. Some sporting events require numerous inputs from specialists, statisticians and all manner of others, as well as the main commentators. For these events we have the GS-GX3 commentary mixer, and the Talent Box that links together for numerous commentary inputs.
- Question 9** *Why would I need a producer input?*
Having a producer at the commentary box allows them to monitor all the incoming sources and have access to the talkback circuits, so it is a common combination. In some events a producer is essential, that is why some Glensound units have dedicated producer units separate from the commentators.

- Question 10** *Why do you have mixed programme outputs and direct mic outputs?*
 In the simplest operation, the programme mix happens on the commentary unit itself and a programme output is produced ready for broadcast. In larger events where there is a main audio mixer, the engineer would rather have direct separate control of the commentary audio. In this scenario, the commentators' audio is taken from the individual direct outputs and brought onto the audio mixer as separate channels. Now the engineer mixes the commentary on the audio mixer.
- Question 11** *Is a DC power input important?*
 An external DC power input has two functions. One is as a backup. In certain events, it is an extra level of security to have a battery connected and on standby, should the main power fail. Secondly, it is a direct power source, so if mains power is not available your unit can be powered from an external 12v DC battery source.
- Question 12** *Why do I need a commentary system to be in two parts?*
 On an outside broadcast, it is common to have a broadcast vehicle parked outside a sports ground with the commentary booth inside the ground. Connecting all the commentators' mics, talkbacks, and outputs independently would result in a lot of cable runs, often at distances of up to 500m. Using a suitable GlenSound system, a single cable will connect all bi-directional audio circuits and provide power to the commentary box too. It is a much more elegant solution.
- Question 13** *What are the differences between coax, multi-wire, copper Ethernet, and fibre Ethernet links in the two part commentary systems?*
 Coax cable is readily available on an outside broadcast vehicle and it is very rugged. As well as carrying the audio, data and power can also be passed along the same cable. However, analogue co-axial systems do not have the same audio quality as direct multi-wire audio links, digital coaxial, or Ethernet links. Multi-wire systems preserve audio quality and offer great performance figures. The DEF32 systems require the commentators' unit and the commentary control unit to be in the same location and uses very large cable. The CAT5 systems allows a link distance of about 150m, but the network cables used are not as robust or reliable as coax. Fibre systems offer the best audio quality and the longest possible link distances. Fibre is not as tough as a coax link and it does not carry power, so commentary units on a fibre link system need to be powered locally.
- Question 14** *Are the compressor/limiter systems necessary?*
 Critical, that is why all GlenSound commentary systems have a carefully designed compressor/limiter system. Sports commentary has to manage audio inputs from whispered tones of snooker commentators, up to the screams of football commentators. The commentary system must manage these varying input levels and output low noise, undistorted audio. The compressor/limiter is a very important part of this quality preservation chain.
- Question 15** *Why do the commentators need so many sources to monitor?*
 The more relevant information that the commentator receives, the better he will be able to perform his job. If he receives the programme audio feed as broadcast, he will hear if any problems occur. If he hears the international sound of the stadium crowd he can react to it in the appropriate way. If he receives advice on mic levels or popping from the engineer he can make correct actions. If he receives off air instruction from his co-ordinator he can hit his cues and be aware of timings. If he has a local input from a sports statistician he can appear expert on the sport as if he knew it himself. All of these sources require a multiple input headphone mixer, and they will ultimately result in a better commentary production.
- Question 16** *Can I modify one of your standard units?*
 GlenSound was born out of making and developing custom designs. If you requirements differ from what we have, please let us know and we will design the unit that you want, providing block diagrams and panel views in advance so you can really see what you will get and how it will perform.

GlenSound Around The World Of Sport

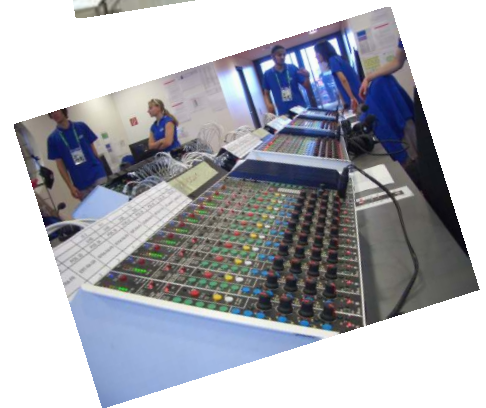

Glensound Commentary - Under the Skin

The products of Glensound are well known for reliability and long life, but what you may not know is some of the reasons why. Glensound have a total quality procedure during development, manufacture and testing to minimise the risk of problems in the field and to ensure long life.

There are numerous design features that add to Glensound's long life quality system. Here are a few examples:

Pot Shafts

We use short shafts and wide flange pot knobs. Outside broadcast environments are harsh where equipment inevitably receives bangs and knocks and is occasionally dropped. Should anything land on the top of our units, the wide pot flanges will hit the units top panel before putting any pressure on the pot shaft itself, thus reducing the possibility of pot damage.

Side Cheeks

Most Glensound units have nylon dipped sides. We nylon dip rather than paint due to the expected life cycle of our products being over 15 years. Paint chips and flakes; after several years it will start to look unsightly. In contrast, nylon will not flake and is much better at absorbing knocks. Any knocks in the surface will simply leave a chip that is barely visible where the surface will remain white underneath and not flake.

Laser Etching

Glensound panels are not screen printed. Screen printing has a relatively short life span; where our products are expected to last over 15 years, screen printing techniques are likely to be worn off. Our anodised panels are laser etched for permanent legends that do not wear. As we print each panel ourselves, this makes customisation very easy for bespoke specifications that require for example, the panel wordings in a different language or adding a corporate logo on the panel.

Original Component Sourcing

Glensound only use quality original components. In the component market there are many third party cheap options which may suffice for a few years, but would not stand the test of time. Glensound have long standing relations with the most significant electronic component suppliers; we never use grey market cheaper options.

Components Chosen for Performance Endurance

There are always cheap options, but at Glensound we always ask ourselves 'is this still going to be working in 15 years?'. An example of this is with our power supplies. If the power fails, it becomes irrelevant

the level of quality and performance the unit has to offer, it will simply cease to function! A power supply is a very expensive component where cost cutting options can present an appealing solution, however, the consequences of sub-standard equipment can leave the user frustrated, red faced and ultimately cut off! Our power supplies are 4 times the price than that of far eastern options, but the performance justifies the cost.....they are proven to last much longer!

Glensound's Final Test And Quality Control Procedure

Before final assembly, all products are passed to one of our dedicated test engineers. 'Test' is one of the most exhaustive and time consuming processes in product manufacture, but one that is never compromised.

All circuits and components are tested for correct operation. Using highly calibrated test equipment, line up tones and measurements are made across all systems and compared with our reference levels. Circuit board level testing ensures any potential problems are found and remedied. Testing can include fridge and oven tests, along with our vibration table, and RF chamber if necessary.

After final assembly the unit is tested in every possible combination of use, including checking reference levels of outputs and calibration of meters. The process is concluded by the unit undergoing 24 hour (minimum) soak test before they are passed for sale.

Factory Visits

Glensound are a family run business based in Maidstone, the county town of Kent. We have an old fashioned work shop for 'metal bashing', an EMC test chamber with various quality control machines, two surface mount pick and place machines, wire benches, test benches, a whole building full of test engineers, and a rather boring office building for doing the paperwork! If you are interested to see what our facility is like, we would be happy to show you around, then you can make your own decision on what our design and manufacture is really like. Give us a call and we will arrange a factory visit for you - tea, coffee and biscuits included!

Band Pass Filter

A band pass filter filters out audio outside the desired range, only allowing the required frequencies through. GlenSound would typically use a band pass filter on a mic input to remove frequencies outside of the vocal range.

CU or dCU

An abbreviation of (digital) Commentators' Unit. The CU is the box operated by the commentator (where the headphone and microphone are connected).

CCU or dCCU

An abbreviation of (digital) Commentary Control Unit. In a two part commentary system, the CCU is the base station operated by the engineer (contains all of the audio inputs and outputs).

Commentator

An individual who commentates on the events and actions of sport or news. Other common phrases are announcer, sportscaster, newscaster, pundit, voice over, presenter, or reporter.

Commentary Box

The device a commentator connects their headphones and microphone to. It allows them to manage their own microphones on/off button and monitor a variety of sources. Most units also feature integrated four wire/IFB talkback to allow them to communicate with an engineer or the programme co-ordinator for example. Line level outputs of the inputs are provided, often with a mixed output of all mics.

Compressor

All GlenSound units feature an input compressor/limiter configured for the special requirements of the commentator, and has been fine tuned over 30 years. Above a preset point (the threshold), outgoing audio level is reduced in relation to the input, gradually at first, then more so as level increases, for balanced audio control of the peaks. This is an essential function in a commentary unit due to the level extremes of a commentator's input audio.

Condenser Microphones

A typically higher quality microphone over dynamic types as they require less energy from the sound wave to operate. Electronics inside the microphone require powering which can be achieved through batteries or more typically from the device to which they are connected (via the mic cable) – this is known as 'Phantom Power'.

Config+

A GlenSound developed system for programming the operation of push buttons into different operational modes to suit the operator's preference.

Co-ordination Circuit

This is the main off air communication channel between the commentators, the engineer and the co-ordinator. The co-ordinator is an editorial position responsible for the commentators, usually a producer or director.

Copper Ethernet

Normal CAT5 or 6 interconnections using normal network cabling.

Cough Button

A non-latching button that turns off the microphone input only when it is held down.

Dynamic Microphones

A moving coil microphone with a diaphragm inside a magnetic field that vibrates to incoming audio levels. This generates a varying current in the coil. They do not require a power source.

ENG

Electronic news gathering. Describes the process of remotely gathering news.

Fibre Ethernet

An Ethernet connection passed over a fibre Optic Cable.

Four Wire

An audio input and an audio output, each featuring two wires and an earth for a balanced connection.

Headroom

Once a line up level is set, headroom refers to the amount of level the input can take before the output clips. This is a critical area in commentary as sports commentators scream and shout into their microphones. GlenSound work very hard to ensure the output level is clean and distortion free, and any headroom level less than 32dB cannot really be considered a proper commentary unit.

Jack Socket – A Gauge and B Gauge

The standard headphone connection available as a 3.5mm or a 6.35mm socket. Normal 6.35mm jacks are 'A' gauge. 'B' gauge is a slightly larger size and is used by some parts of the BBC. GlenSound devices will operate with A or B gauge 6.35mm jacks, however, once a 'B' gauge jack has been inserted into the socket, an A gauge jack can no longer be used.

IBC

An abbreviation for International Broadcast Centre. Major sports events will set up an IBC as a central hub of technical resources, and the main location for links to external sources.

IFB

Interruptable foldback (or feedback). A four wire output is looped from its own input, with an ability for an operator to 'interrupt' the circuit with talkback.

International Sound

International sound is the phrase used to describe atmosphere effects – stadium background, crowd cheering, etc. When a broadcaster acquires a video feed, they are usually given international sound so they can mix their own commentary audio on top.

Lazy Talkback

In this mode, the button will simply toggle – press once for 'on', press again for 'off'.

Line Ident

A small recording device that will record an identification message then loop it, with or without line up tone. This is used to inform the studio that a link is operational and ready to go, even when an engineer is not present.

Line Up Level

The signal level at which the commentary unit is designed to operate. With Glensound products, this is typically 0dBu (equivalent to PPM 4).

Loops

Input and output contact closures to indicate button presses or incoming signals. Normally used to interface commentary four wire circuits with external intercom systems or to indicate mic live.

Low Frequency Cut

A filter that removes all frequencies below a certain level. Often used on mic inputs to remove un-wanted low frequency rumbles.

Matrix/Router (digital)

A system that allows multiple connections and switch points between a certain number of inputs and outputs. The routing of the inputs and outputs is configurable and can be changed to suit requirements.

Momentary Talkback

In this mode, the talkback button is only active whilst held down. When released, the unit will revert to its previous state.

Off Tube

This is when commentary on an event is produced in a studio whilst watching the event on a monitor (the 'tube').

PPM Meter

A metering scale developed by the BBC that displays peak signal levels. The range is from 1-7 with 4dB steps between each point. The reference line up level of 0dB is at PPM4.

Phantom Power

Phantom power is a method of moving DC current through a cable at the same time as the audio signal, to power a condenser microphone. Phantom power is either 12, or 48 volts. Condenser microphones used in commentary typically require 12 volts, but many Glensound units provide up to 48 volts.

Ribbon (Lip) Microphones

Ribbon mics have a metal ribbon that vibrates to sound waves in a magnetic field – as in dynamic microphones. They respond to pressure gradient rather than sound

pressure and have high side rejection. This makes Ribbon microphones particularly suitable in live sports commentary.



www.glensound.co.uk



GlenSound
Electronics Ltd



E & OE

GlenSound Electronics Ltd

6 Brooks Place, Maidstone, Kent, ME14 1HE, UK

Tel: +44 (0) 1622 753 662 Fax: +44 (0) 1622 762 330

Email: sales@glen-sound.co.uk Web: www.glen-sound.co.uk