

TASCAM

DR-60D MK II

Linear PCM Recorder

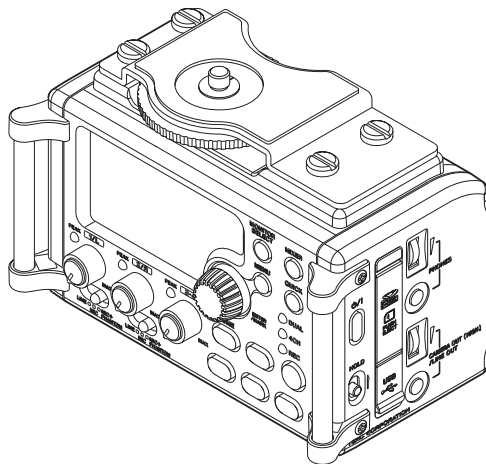

REFERENCE MANUAL

Contents

1 – Introduction.....	5
Features.....	5
Conventions used in this manual.....	6
2 – Names and functions of parts	7
Front panel.....	7
Left side panel	10
Right side panel	11
Rear panel	12
Top panel.....	13
Bottom Panel	13
Home Screen.....	14
Recording Screen	16
Menu item list	18
Using menus	19
Basic operation.....	20
3 – Preparation	22
Powering the unit.....	22
Power sources	22
Using AA batteries.....	22
Using an AC adaptor (sold separately)	23
Using an external battery pack (sold separately).....	23
Using USB bus power	24
Turning the power on and off (putting it in standby).....	25
Starting up the unit.....	25
Shutting down (putting the unit in standby)	25
Resume function.....	26
Setting the date and time	26
Inserting and removing SD cards.....	27
Inserting the SD card.....	27
Removing the card.....	27
SD card write protection switches	28
Preparing an SD card for use	29
Camera connection and attachment	29
Connecting monitors and headphones	30
Monitoring.....	30
Enabling monitoring	30
Selecting the monitored signal.....	31
4 – Recording	32
Selecting file format, sampling frequency, and maximum file size	32
Preparing the recording inputs.....	33
Connecting microphones	33
Recording an external device (LINE IN)	34
Setting the input types	34
Using phantom power.....	35
Using plug-in power.....	36
Adjusting the input level/Muting	36
Using the limiter	38
Using the low-cut filter	39
Set where to save the file	39
Overview of recording modes	39
Recording (MONO/STEREO recording)	40
Make recording settings	40
Starting the recording	41
File names when recording in MONO/STEREO	41
Simultaneously recording two files at different input levels (DUAL REC).....	42
Enabling dual recording.....	42

Starting dual recording	43
Dual recording file names	44
Recording 4 channels	44
Making 4-channel recording settings	44
Starting 4-channel recording.....	45
File names when recording in 4-channel	46
Recording automatically (AUTO REC).....	46
Creating and changeover to a new file during continued recording (Track increment).....	48
Manual track increment during recording	48
Automatic track increment by file size.....	48
Mark function	49
Adding marks manually to a recording.....	49
Adding marks automatically to a recording.....	49
Moving to a mark position	49
Recording the moment before pushing RECORD (PRE REC).....	50
Delaying the start of recording (REC DELAY)	50
Self-timer function.....	51
Using the auto tone function	51
Setting the auto tone function.....	51
Setting auto tone length	52
Adjusting the volume of the auto tone and the slate tone.....	52
Adding slate tones.....	52
Recording duration	53
5 – Working with Files and Folders (BROWSE screen) ... 54	
Screen navigation	54
Icons on the BROWSE screen	55
File operations.....	55
Folder operations.....	56
Creating a new folder	57
6 – Playback 58	
Adjusting playback volume	58
Setting the playback area (AREA)	58
Selecting a folder for the playback area (1)	59
Selecting a folder for the playback area (2).....	60
Selecting files for playback (skip).....	60
Playback.....	61
Pausing	61
Stopping.....	61
Rewinding and fast-forwarding (search)	61
Changing the playback position.....	61
Repeat playback (REPEAT)	61
Moving back a few seconds for replay (jump-back playback).....	62
Playback of files recorded using dual recording	62
7 – QUICK button operations 63	
Features of the QUICK button	63
Opening the quick menu	64
Closing the quick menu	65
Deleting the selected file (Quick Delete).....	65
Dividing the selected file (DIVIDE)	65
Increasing the perceived overall sound pressure to enhance listenability (Level Alignment)	67
Using the playback equalizer	68
Setting mic input gain with the quick menu	68
8 – Mixer 69	
Making mixer settings.....	69
Using the MS decoder	70
Decoding the input sound as you record	70

Contents

Decoding the playback sound	71	Setting the wired remote control	80
MS decoder settings.....	71	Using the wired remote control	80
9 – Connecting with a computer.....	72	Overview of mode functions	80
Transferring files to a computer	73	12 – Messages	81
Transferring files from a computer.....	73	13 – Troubleshooting.....	84
Disconnecting from a computer.....	73	14 – Specifications	86
10 – Settings and Information	74	Ratings.....	86
Viewing Information (INFORMATION).....	74	Inputs and outputs.....	86
File information page.....	74	Analog audio input and output	86
Card information page	75	Control input and output	87
System information page.....	75	Audio performance	87
System Settings and Formatting (SYSTEM)	76	Computer compatibility	87
Setting the automatic power saving function	76	Other specifications	88
Setting the backlight.....	76	Dimensional drawings	89
Adjusting the display contrast.....	76		
Setting the type of AA batteries	76		
Setting the phantom power voltage	76		
Restoring the factory settings	77		
Using QUICK FORMAT	77		
Using FULL FORMAT	77		
Setting the format of file names	78		
File name format	78		
Setting the WORD item	78		
Resetting the number (COUNT).....	78		
11 – Using the REMOTE jack	79		
Footswitch (TASCAM RC-3F)	79		
Setting footswitch operation.....	79		
Using the footswitch	80		
Remote control (TASCAM RC-10).....	80		

Thank you very much for purchasing the TASCAM DR-60DMKII Linear PCM Recorder. Please read this Owner's Manual carefully in order to maximize your use of all the unit's features. We hope that you will enjoy using this recorder for many years to come.

After you have finished reading this manual, please keep it in a safe place for future reference.

You can also download the Owner's Manual from the TEAC Global Site (<http://teac-global.com/>).

Features

This recorder includes audio inputs and outputs that are suitable for use with digital single-lens reflex (DSLR) cameras, enabling the recording of high-quality audio with DSLR video.

- Compact audio recorder that uses SD/SDHC cards as recording media
- TASCAM original High Definition Discrete Architecture (HDDA) microphone preamps provide high-quality recording inputs
- In addition to ordinary stereo recording, simultaneous recording of up to four channels is possible
- Four channels can be mixed down to two for stereo output
- Recording levels can be adjusted independently for the 1/L, 2/R and 3-4 inputs
- Dual recording function allows two files to be recorded simultaneously at different levels
- 44.1/48/96 kHz, 16/24-bit, linear PCM (WAV format) recording possible
- Broadcast Wave Format (BWF) supported as WAV recording format
- XLR mic/line inputs can provide phantom power (+24V/+48V)

TRS mic/line inputs (1/L and 2/R) support +24dBu input when set to LINE

- Stereo mini jack input supports mics that require plug-in power, allowing the input of video mics and other high-output mics (+10dBV maximum input level)
- Slate tone functions (automatic/manual) simplify synchronization of video files when editing
- CAMERA OUT connector allows the high-quality audio from this unit to be output to a DSLR camera for recording
- CAMERA IN connector enables convenient monitoring of audio from a DSLR camera
- Auto-record function starts recording automatically when a set sound input level is detected
- Mid-side decoding function can be used with MS mics
- Auto-record function can automatically start and stop recording at set levels
- Can start recording a new file automatically when a maximum file size set in advance is reached without interrupting recording
- A QUICK button is available for easy access to various functions
- Track incrementing function allows a recording to be split by creating a new file when desired
- Pre-recording (PRE REC) function allows the unit to record the 2 seconds of sound before recording is activated
- Limiter function is available to reduce the level automatically in case of excessively large input.
- Low cut filter conveniently reduces low-frequency noise
- Self-timer function to start recording after a set period of time.
- Jump back and play function allows the last several seconds of the currently played file to be replayed again by simply pressing a button

1 – Introduction

- Delay function that eliminates time lags caused by differences in the distances of two sets of inputs from the sound source
- DIVIDE function allows files to be split where desired
- MARK function convenient for moving to specific locations
- Equalizers function for playback, and level alignment function to enhance the perceived overall sound pressure
- File name format can be set to use a user-defined word or the date
- Resume function to memorize the playback position before the unit is turned off (enter standby).
- 3.5 mm (1/8") line/headphones output jack
- 128 x 64 pixel LCD with backlight
- Mini-B type USB 2.0 port
- Operates on 4 AA batteries, an AC adaptor (sold separately: TASCAM PS-P515U), external battery pack (sold separately: TASCAM BP-6AA) or USB bus power
- Tripod mounting threads (bottom) and DSLR screw attachment that allows attachment and removal with a coin (top)
- Dedicated remote control jack (for use with RC-10 and RC-3F (sold separately))
- HOLD switch to prevent accidental operation
- Handles on the front left and right sides protect the screen and can be used to attach a shoulder belt

Conventions used in this manual

In this manual, we use the following conventions:

- When we refer to buttons, connectors and other parts of this unit and other equipment, we use a bold font like this: **MENU** button.
- When we show messages, for example, that appears on the unit's display, the typeface looks like this: REPEAT.
- SD memory cards are called "SD cards".
- We refer to digital single-lens reflex cameras as "DSLR cameras" or "DSLRs".
- Words that appear on the computer display are shown in quotation marks like this: "DR-60DMKII"
- Additional information is provided as necessary as tips, notes and cautions.

TIP

These are tips about how to use the unit.

NOTE

These provide additional explanations and describe special cases.

CAUTION

Failure to follow these instructions could result in injury, damage to equipment or lost recording data, for example.

2 – Names and functions of parts

Front panel

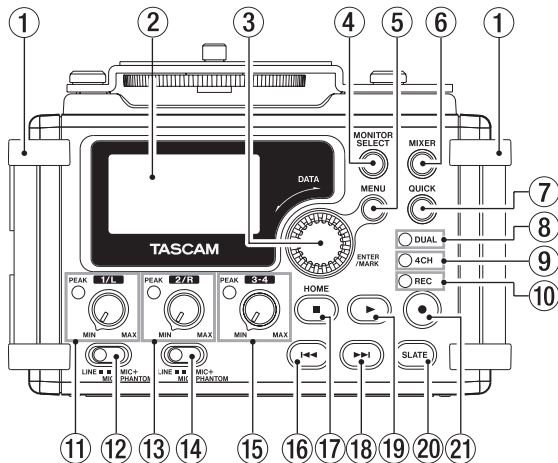

① **Handles**

Attach a strap, for example, here.

② **Display**

Shows a variety of information.

③ **DATA dial (ENTER/MARK)**

Turn to select items and change values on setting screens.

Use also to change the playback position in a file.

Push to confirm selections on setting screens and to answer “YES” to confirmation pop-up messages.

Press during recording to add a mark manually. (See “Adding marks manually to a recording” on page 49.)

Press the ◀◀ or ▶▶ button while pressing and holding this dial to move to the previous or next mark, respectively. (See “Moving to a mark position” on page 49.)

④ **MONITOR SELECT button**

When not playing back, press to open the monitoring source selection pop-up menu.

When playing back dual-recorded files, press to switch between files.

⑤ **MENU button**

When the Home Screen or MIXER screen is open, press to open the MENU Screen.

When a setting screen is open, press to move up one level in the menu. When the MENU Screen is open, press to return to the Home Screen.

⑥ **MIXER button**

Press this button to open the MIXER screen.

When the MIXER screen is open, press this button to return to the Home Screen.

2 – Names and functions of parts

⑦ QUICK button

Press when the Home Screen, BROWSE screen or MIXER screen is open to show the quick menu pop-up.

The function to be shown depends on the state of the unit when the button is pressed.

Recorder status	Functions shown
Stopped	Delete/divide current playback file, level align, playback EQ and mic input gain setting functions
Playing back	Level align and playback EQ functions
Recording standby	Mic input gain setting function
Recording	
MIXER screen open	Mic input gain setting function
BROWSE screen open	File/folder operations

⑧ DUAL indicator

This lights orange when recording in dual recording mode.

⑨ 4CH indicator

This lights orange when recording in 4-channel recording mode.

⑩ REC indicator

This blinks when in recording standby and lights red when recording.

⑪ 1/L knob and PEAK indicator

Use this knob to adjust the input level from the 1/L connector on the left side of the unit.

The 1/L PEAK indicator lights when the 1/L input level is about to cause distortion. This also lights if distortion occurs in the analog circuitry during mic input, but this does not light if distortion occurs in the analog circuitry during line level input. (See “Adjusting the input level/Muting” on page 36.)

⑫ Input switch (1/L)

Set the input type for the 1/L connector and whether phantom power is on or off.

⑬ 2/R knob and PEAK indicator

Use this knob to adjust the input level from the 2/R connector on the left side of the unit.

The 2/R PEAK indicator lights when the 2/R input level is about to cause distortion. This also lights if distortion occurs in the analog circuitry during mic input, but this does not light if distortion occurs in the analog circuitry during line level input. (See “Adjusting the input level/Muting” on page 36.)

⑭ Input switch (2/R)

Set the input type for the 2/R connector and whether phantom power is on or off.

⑮ 3-4 knob and PEAK indicator

Use to adjust the input level from the 3/4 connector on the left side of the unit.

The 3-4 PEAK indicator lights when the 3-4 input level is about to cause distortion.

2 – Names and functions of parts

16 **⏮ button**

During playback or when stopped in the middle of a file, press to return to the beginning of the file.

When stopped at the beginning of a file, press to skip to the beginning of the previous file.

Press and hold to search backward.

Press this button while pressing and holding the **DATA** dial to return to the previous mark.

On the setting screens, use this button to move the cursor left. On the **BROWSE** Screen, press this button to move up a level.

17 **Stop (■) [HOME] button**

Press this button during playback to cause the playback to pause at the current position. Press this button during pause time to return to the beginning of the playback file.

Press this button during recording or recording standby to cause the recording to stop.

When any other screen is open, press this button to return to the Home Screen. Use this button to answer "NO" to a confirmation message.

18 **⏭ button**

When stopped or playing back, press to skip to the next file.

Press and hold to search forward.

On the setting screens, use this button to move the cursor right.

Press this button while pressing and holding the **DATA** dial to move to the next mark.

On the **BROWSE** Screen, press this button to move down a level. If a file is selected, the file is loaded and the unit returns to the Home Screen and stops.

19 **▶ (playback) button**

When the Home Screen is displayed and playback is stopped, press this button to start playback.

During playback, press this button to start jump-back playback. (See "Moving back a few seconds for replay (jump-back playback)" on page 62.)

When a file or folder is selected in the **BROWSE** screen, press this button to return to the Home Screen and play the file or the first file in the folder from the beginning.

20 **SLATE button**

Press and hold during playback to record a slate stone. (See "Adding slate tones" on page 52.)

21 **● (record) button**

Press when stopped to start recording standby

Press when recording to pause recording (resume recording standby).

2 – Names and functions of parts

Left side panel

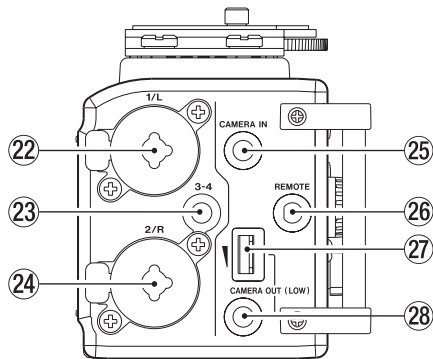

NOTE

Do not apply excessive force when plugging in external devices to connect them to this unit or during use. In particular, be careful when using a standard-to-mini plug adapter, because the application of unintended force could result in damage to the device.

22 1/L connector (XLR/TRS)

These are balanced analog XLR/TRS combo jacks for microphone and line level inputs.

XLR (1: GND, 2: HOT, 3: COLD)

TRS (Tip: HOT, Ring: COLD, Sleeve: GND)

23 3-4 connector (3.5mm stereo mini jack)

This TRS analog input jack can provide plug-in power.

TRS (Tip: HOT, Ring: COLD, Sleeve: GND)

24 2/R connector (XLR/TRS)

These are balanced analog XLR/TRS combo jacks for microphone and line level inputs.

XLR (1: GND, 2: HOT, 3: COLD)

TRS (Tip: HOT, Ring: COLD, Sleeve: GND)

CAUTION

- *Confirm that phantom power is OFF before connecting a line level device to a 1/L connector or 2/R connector. If you connect a line level device while phantom power is being supplied, that device and this unit could be damaged.*
- *When using a condenser microphone, before connecting to and disconnecting from a 1/L connector or 2/R connector, confirm that the phantom power for that jack is OFF. If you connect or disconnect a mic while phantom power is being supplied, that mic and this unit could be damaged.*
- *Do not connect an unbalanced dynamic mic to an XLR connector when phantom power is being supplied. Doing so could damage that mic and this unit.*

25 CAMERA IN connector (3.5mm stereo mini jack)

Connect to the audio output of a camera.

Refer to the camera's operation manual to identify this connector on the camera. (See "Camera connection and attachment" on page 29.)

26 REMOTE connector (2.5mm TRS jack)

Connect a TASCAM RC-3F footswitch or TASCAM RC-10 wired remote control (both sold separately) here to enable remote starting and stopping of playback and other functions. (See "11 – Using the REMOTE jack" on page 79.)

2 – Names and functions of parts

- 27 **CAMERA OUT (LOW) volume control**
Use to adjust the volume output from the **CAMERA OUT (LOW)** connector.

- 28 **CAMERA OUT (LOW) connector (3.5mm stereo mini jack)**
Connect a camera external mic connector.
Refer to the camera's operation manual to identify this connector on the camera. (See "Camera connection and attachment" on page 29.)

Right side panel

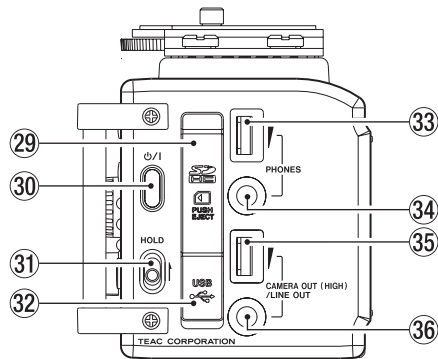

NOTE

Do not apply excessive force when plugging in headphones and external devices to connect them to this unit or during use. In particular, be careful when using a standard-to-mini plug adapter, because the application of unintended force could result in damage to the device.

- 29 **SD card slot**
Insert an SD card here.
- 30 **ON/OFF button**
Press and hold this button to turn the unit's power ON or OFF(Standby). (See "Turning the power on and off (putting it in standby)" on page 25)

2 – Names and functions of parts

- ① **HOLD switch**
Shift to the top end (in the direction of the arrow) to engage the hold function.
All buttons are inoperative when hold is ON.
- ② **USB port**
Use the included USB cable to connect with a computer USB port. (See “9 – Connecting with a computer” on page 72.)
Power can be supplied through the USB cable provided with the unit or an AC adaptor (sold separately: TASCAM PS-P515U).

CAUTION

Always connect the recorder directly to a computer. Do not use a USB hub.

- ③ **PHONES volume control**
Use to adjust the volume output from the **PHONES** jack.
- ④ **PHONES jack (3.5mm stereo mini jack)**
Connect stereo headphones to this stereo mini jack.
Use the **PHONES** control to adjust the volume.

CAUTION

*Before connecting headphones, lower the **PHONES** volume to the minimum level. Failure to do so could result in a sudden loud noise that could harm hearing, for example.*

- ⑤ **CAMERA OUT (HIGH)/LINE OUT volume control**
Use to adjust the volume output from the **CAMERA OUT (HIGH)/LINE OUT** jack.
- ⑥ **CAMERA OUT (HIGH)/LINE OUT jack (3.5mm stereo mini jack)**
Use this to connect with the line input jack of an amp or other equipment.

Use the **CAMERA OUT (HIGH)/LINE OUT** control to adjust the volume.

Rear panel

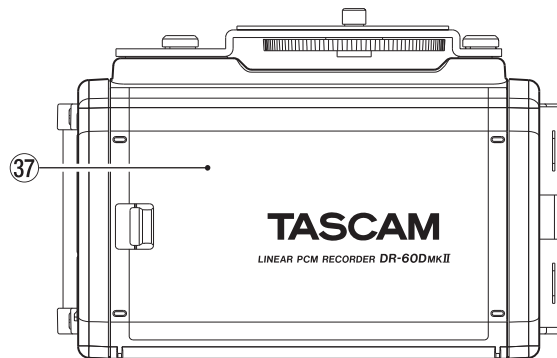

- ⑦ **Battery compartment cover**

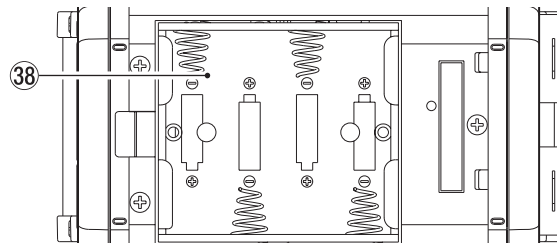

2 – Names and functions of parts

- 38 **Battery compartment**
Install batteries (4 AA batteries) in this compartment to power the unit. (See “Using AA batteries” on page 22.)

Top panel

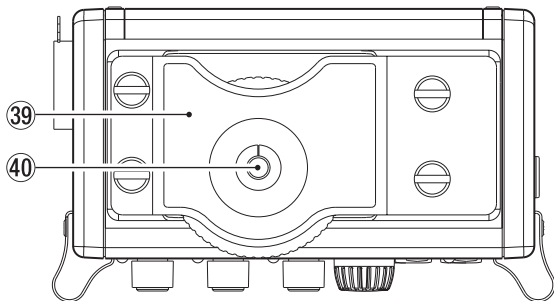

- 39 **DSLR attachment bracket**
Use this bracket, which is preinstalled on the unit, with the DSLR mounting screw.
If you do not want to use this bracket, use a coin or other tool to remove the four attachment screws.
- 40 **DSLR mounting screw (1/4-inch)**
Use to attach this unit to the bottom of a camera or a rack that supports camera mounting screws, for example.

Bottom Panel

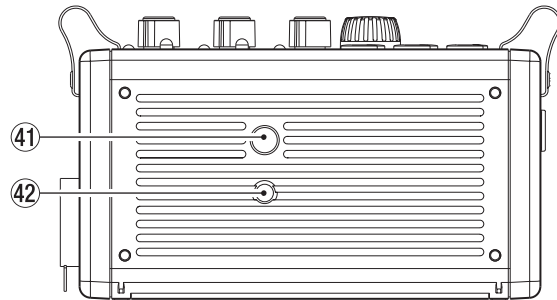

- 41 **Tripod mounting threads (1/4-inch)**
Use to attach this unit to a tripod.

CAUTION

- *Tighten the unit securely to the tripod or microphone stand to prevent it from falling off.*
 - *Place the tripod or microphone stand on a level surface when using it with this unit.*
 - *Some tripods have different screw specifications that make direct connection impossible. Use a commercially-available adapter with such tripods.*
- 42 **Video camera pin hole**
When using a tripod with a pin for video cameras, align this hole with the pin when attaching the unit to the tripod.

2 – Names and functions of parts

Home Screen

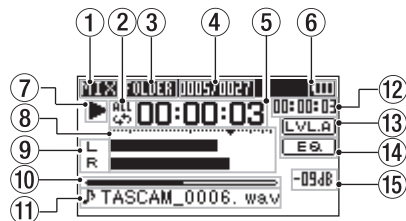

NOTE

When monitoring, some meters, icons and other items will change to recording screen appearance.

① Monitoring mode



This shows what audio is now being monitored.

Indicator	Meaning
MIX	Mix of channels 1-4, or dual recording mode main file
SUB	Dual recording mode sub file
1+2	Mix of channels 1-2
3+4	Mix of channels 3-4
CAM	CAMERA IN jack sound input
CH1	Channel 1 sound input
1-M	Left channel of dual recording mode main file
1-S	Left channel of dual recording mode sub file
CH2	Channel 2 sound input

Indicator	Meaning
2-M	Right channel of dual recording mode main file
2-S	Right channel of dual recording mode sub file
CH3	Channel 3 sound input
3-M	Left channel of dual recording mode main file
3-S	Left channel of dual recording mode sub file
CH4	Channel 4 sound input
4-M	Right channel of dual recording mode main file
4-S	Right channel of dual recording mode sub file

② Repeat playback setting

One of the following icons appears according to the current setting.

-  Single file playback
-  Single file repeat playback
-  All file repeat playback

③ Playback area

This shows the current playback file area.

- ALL All files in the MUSIC folder
- FOLDER All files in the selected folder

④ Current playback file number/total number of files



This shows the current file number and total number of files in the current playback area.

⑤ Elapsed time

This shows the elapsed time (hours: minutes: seconds) of the current file.

2 – Names and functions of parts

⑥ Power supply status

When a battery is being used, a battery icon shows the amount of power remaining in bars (“”, “”, “”).

The battery is almost dead and the power will soon turn off (standby) if the icon has no bars “”.







When using the PS-P515U AC adaptor (sold separately) or USB bus power, “” appears.

NOTE

Sometimes a Battery Low warning appears when recording or conducting other demanding operations even when battery power remains.

⑦ Recorder operation status

This icon shows the recorder operation status.

Indicator	Meaning
	Stopped
	Paused
	Playing back
	Fast-forwarding
	Fast-rewinding
	Skipping forward
	Skipping backward

⑧ Level meter

These show the levels of the input playback signals.

⑨ Track status display

This icon changes according to the recording mode.

Indicators (examples)	Meaning
L R	Playing a file recorded in MONO or STEREO mode
CH1 / CH2 / CH3 / CH4	Monitoring in MONO mode
1-2 / 3-4	Monitoring in STEREO mode
CH1 1-2 -E / -E	Playing a file recorded in DUAL MONO or DUAL ST mode or monitoring in these modes
1-2 3-4	Playing a file recorded in 4CH mode or monitoring in this mode

⑩ Playback position display

The current playback position is shown by a bar. As playback progresses, the bar extends to the right.

⑪ File name

This shows the name of the file playing back unless there are multiple files recorded in 4-channel recording mode or dual recording mode. In these cases, it shows the project name.

⑫ Remaining time

This shows the remaining time (hours: minutes: seconds) of the current file.

2 – Names and functions of parts

13 Level align status

This icon shows whether the level align function is on or off. (See “Increasing the perceived overall sound pressure to enhance listenability (Level Alignment)” on page 67.)

 Level align function off

 Level align function on

14 Playback equalizer status

This icon shows whether the playback equalizer is on or off. (See “Using the playback equalizer” on page 68.)

 Playback equalizer off

 Playback equalizer on

15 Peak value in decibels (dB)

The maximum level that occurs in a fixed period of time is displayed digitally.

Recording Screen

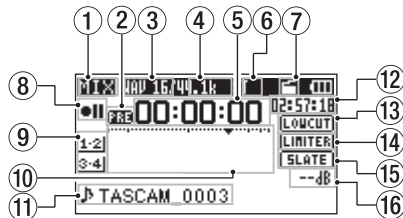

1 Monitoring mode

This shows what audio is being monitored now.

Indicator	Meaning
MIX	Mix of channels 1-4, or dual recording mode main file
SUB	Dual recording mode sub file
1+2	Mix of channels 1-2
3+4	Mix of channels 3-4
CAM	CAMERA IN jack sound input
CH1	Channel 1 sound input
1-M	Left channel of dual recording mode main file
1-S	Left channel of dual recording mode sub file
CH2	Channel 2 sound input
2-M	Right channel of dual recording mode main file
2-S	Right channel of dual recording mode sub file
CH3	Channel 3 sound input

2 – Names and functions of parts

Indicator	Meaning
3-M	Left channel of dual recording mode main file
3-S	Left channel of dual recording mode sub file
CH4	Channel 4 sound input
4-M	Right channel of dual recording mode main file
4-S	Right channel of dual recording mode sub file

- ② **Prerecording or Auto recording function status**
 "PRE" appears when the prerecording function is ON, and in recording standby.
 "AUTO" appears when the auto recording function is ON, and recording.
- ③ **Recording format**
 This shows the file recording format.
 WAV16, WAV24, BWF16 or BWF24
- ④ **Recording sampling frequency**
 This shows the file recording sampling frequency.
 44.1kHz, 48kHz or 96kHz
- ⑤ **Elapsed recording time**
 The elapsed recording time of the file appears as hours: minutes: seconds.
- ⑥ **Number of recording channels**
 This shows the number of recording channels in the file.
 ST or MONO

- ⑦ **Auto tone function status**
 This icon shows whether the auto tone function is on or off. (See "Using the auto tone function" on page 51.)

No icon	Auto tone off
	Auto tone on

- ⑧ **Recorder operation status**
 This icon shows the recorder operation status.

Indicator	Meaning
●	Recording standby or Recording paused
●	Recording
	Self-timer recording activated

- ⑨ **Input source**
 This icon shows the input source.

Indicators (examples)	Meaning
CH1 / CH2 / CH3 / CH4	Mono recording mode input source
1-2 / 3-4	Stereo recording mode input source
CH1 1-2 -E / -E	Dual recording mode input source and gain setting for the second recording (0 to -12)
1-2 3-4	4-channel recording mode input source

- ⑩ **Recording level meters**
 These show the levels of the input audio.
 The ▼ mark at the -12dB position provides a guide when adjusting the input levels.

2 – Names and functions of parts

⑪ File name

This shows the file name that is automatically assigned to a recording file.

This shows the project name when there are multiple files recorded in 4-channel recording mode or dual recording mode.

⑫ Remaining recording time

The remaining recording time on the SD card is shown in hours: minutes: seconds according to the recording mode, sampling frequency and recording format settings.

⑬ Low cut filter status

This shows whether the low cut filter is ON/OFF. (See “Using the low-cut filter” on page 39.)

This icon is shown as light letters on a dark background if the low-cut filter is set to 40Hz, 80Hz or 120Hz for channel 1, channel 2 or channels 3/4.

 : Low cut filter off

 : Low cut filter on

⑭ Limiter function status

An icon appears if the limiter function setting for channel 1, 2 or 3/4 is set to MONO or LINK. (See “Using the limiter” on page 38.)

 : Limiter off

 : Limiter on

⑮ SLATE button setting

This shows the SLATE button setting (enable/disabled). (See “Adding slate tones” on page 52.)

 : SLATE button disabled

 : SLATE button enabled

⑯ Peak value in decibels (dB)

Peak input level values are shown digitally.

Menu item list

Press the **MENU** button to open the MENU screen. The items in this menu are as follows.

Menu item	Function	Pages
REC MODE	Set the recording source.	page 39, page 40, page 42, page 44
INPUT SETTING	Make input settings.	page 36, page 38, page 39
REC SETTING	Make recording settings	page 30, page 32, page 48, page 50, page 51, page 52
AUTO REC	Make auto recording settings.	page 46, page 49
PLAY SETTING	Make play area, repeat playback and jump-back settings.	page 58, page 61
BROWSE	SD card file and folder operations	page 54, page 59, page 60
OTHERS	Show submenu items.	page 26, page 36, page 74, page 78, page 79

2 – Names and functions of parts

The OTHERS submenu appears when OTHERS is selected in the MENU screen. The menu items contained are as follows.

Submenu item	Function	Pages
INFORMATION	Information about the file, SD card, and system	page 74
FILE NAME	File name settings	page 78
DATE/TIME	Date and time settings	page 26
REMOTE	Settings for the TASCAM RC-3F footswitch and TASCAM RC-10 wired remote control (both sold separately)	page 79, page 80
SYSTEM	Various system settings	page 76

CAUTION

- When in recording standby or recording, only the INPUT SETTING and AUTO REC screens are shown.
- When recording, the AUTO REC setting cannot be changed.

Using menus

Use the MENU screen to make various settings.

1. Press the **MENU** button to open the MENU screen.

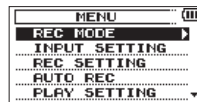

2. Turn the **DATA** dial to select a menu item (highlighted), and press the **DATA** dial or ►| button to move to various settings screens.

Example: PLAY SETTING screen

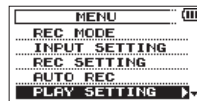

3. Turn the **DATA** dial to select a menu item (highlighted) to be set.

Example: AREA is selected.

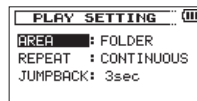

2 – Names and functions of parts

4. Press the **DATA** dial or **▶▶I** button to move the cursor to highlight the value of the setting.

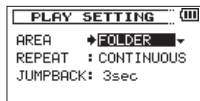

5. Turn the **DATA** dial to change the setting.
6. Press the **DATA** dial or **I◀◀** button to set a different item in the same menu.
This enables you to select a new item. Turn the **DATA** dial again to select an item to be set.
7. Repeat step **3** to **6** as necessary to set each item.
8. To open the **MENU** screen (or **OTHERS** submenu screen), press the **MENU** button.
To return to the Home Screen, press the **Stop (■) [HOME]** button.

Basic operation

Use the following buttons to operate the various screens.

MENU button:

Opens the **MENU** screen.

Stop (■) [HOME] button:

When any other screen is open, press this to return to the Home Screen. Use this to answer “NO” to a confirmation message.

DATA dial:

Turn the **DATA** dial to select items and change values on setting screens. You can also turn the **DATA** dial to change the file playback position.

Press the **DATA** dial to confirm items selected on setting screens and to answer “Yes” to confirmation pop-up messages.

Press the **DATA** dial during recording to add a mark manually. (See “Adding marks manually to a recording” on page 49.)

While pressing and holding the **DATA** dial, press the **I◀◀** button to jump to the previous mark or press the **▶▶I** button to jump to the next mark. (See “Moving to a mark position” on page 49.)

▶▶I button:

Use this to move the cursor (the highlighted area) to the right on the screen, and to open folders on the **BROWSE** screen.

I◀◀ button:

Use this to move the cursor (the highlighted area) to the left on the screen, and to close folders on the **BROWSE** screen.

QUICK button:

This opens the quick menu pop-up.

- When stopped: Delete/divide current playback file, level align, playback EQ and mic input gain setting functions
- During playback: Level align and playback EQ functions
- In recording standby: Mic input gain setting function
- When recording: Mic input gain setting function
- When the **BROWSE** screen is open: File/folder operations
- When the **MIXER** screen is open: Mic input gain setting function

Record (●) button

Opens the **REC MODE** screen.

When the **REC MODE** screen is open, returns to the Home Screen.

MIXER button

Opens the **MIXER** screen.

When the **MIXER** screen is open, returns to the Home Screen.

3 – Preparation

Powering the unit

Power sources

DR-60DMKII can operate on four AA batteries, TASCAM PS-P515U AC adaptor (sold separately) or USB cable provided with the unit (USB bus power).

Alkaline or Ni-MH batteries can be used.

Using AA batteries

Remove the battery compartment cover on the back of the unit. Install 4 AA batteries in the compartment with the ⊕ and ⊖ marks as shown. Then, close the battery compartment cover.

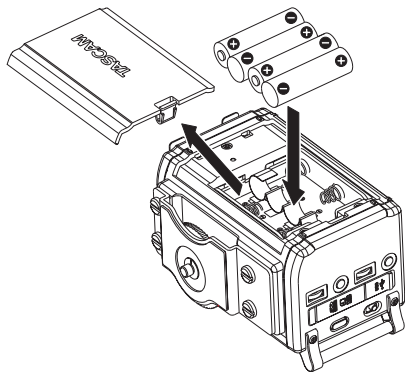

When using AA batteries, set the type of battery in order to accurately show the amount of power remaining and allow the unit to accurately determine whether power is available for proper operation. (See “Setting the type of AA batteries” on page 76.)

CAUTION

- *Manganese dry cell batteries (R6) cannot be used with this unit.*
- *This unit cannot recharge Ni-MH batteries. Use a commercially available recharger.*

NOTE

A great amount of power is required to provide phantom power to a condenser microphone. If you use a condenser microphone while running the unit on AA batteries (NiMH rechargeable or alkaline), the operation time will be shortened.

If you need to operate the unit for a long time, use a TASCAM PS-P515U AC adaptor or TASCAM BP-6AA external battery box (both sold separately) to power the unit.

Using an AC adaptor (sold separately)

Connect the TASCAM PS-P515U AC adaptor (sold separately) and the USB cable to the USB port of the unit as shown in the illustration.

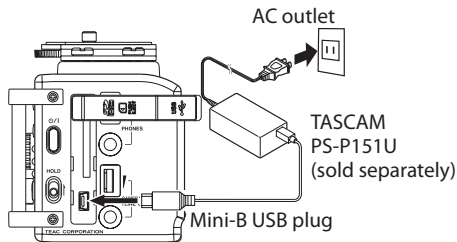

NOTE

When both batteries are installed and the AC adaptor is connected, power will be supplied from the AC adaptor.

CAUTION

- *Never use any adaptor other than the designated TASCAM PS-P515U AC adaptor (sold separately). Use of a different adaptor could cause malfunction, fire or electric shock.*
- *Noise may occur when recording with a microphone if the unit is too close to the AC adaptor. In such a case, keep sufficient distance between the AC adaptor and the unit.*

Using an external battery pack (sold separately)

Connect a TASCAM BP-6AA external battery pack (designed for use with this unit and sold separately) to the recorder with the included USB cable as shown in the illustration. For details, see the BP-6AA Owner's Manual.

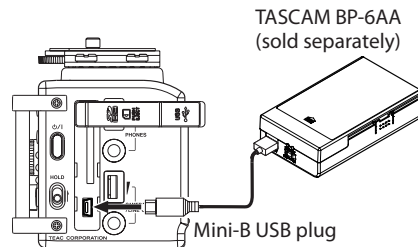

CAUTION

The DR-60DMKII cannot detect the remaining battery charge of a BP-6AA. If you use a BP-6AA to operate the DR-60DMKII without batteries in the recorder itself, the unit might stop operating suddenly if the battery pack runs out of charge. In order to avoid problems, put batteries with sufficient charge into the DR-60DMKII before connecting and using a BP-6AA.

3 – Preparation

Using USB bus power

Connect the unit to a PC using the attached USB cable as shown in the illustration.

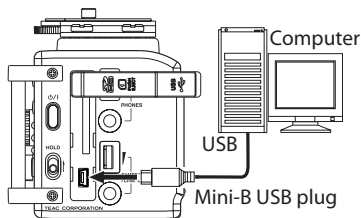

The USB **SELECT** screen appears to choose between USB bus power for power supply or connection with a PC through the USB cable when USB cable is connected after the unit is turned on or when the unit is turned on after connecting the USB cable. Turn the **DATA** dial to select **BUS POWER** and press the **DATA** dial to select power supply from the USB port. The Home Screen will appear.



CAUTION

- Depending on the USB bus power specifications of the computer, this unit might not function when connected to the computer by USB cable. In this case, use a TASCAM PS-P515U AC adaptor (sold separately) or batteries.
- This unit does not support computer power conservation and sleep functions. When powering the unit using the USB bus power of a computer, always turn such functions off.

NOTE

Power is supplied from the USB port if the USB cable is connected to the unit that contains batteries (USB bus power prioritized).

Turning the power on and off (putting it in standby)

CAUTION

- The unit goes in standby mode if shut down when the unit is operating on AC power supplied through the TASCAM PS-P515U AC adaptor (sold separately), or bus power supplied from a USB port of a PC.
- Turn down the volume of the sound system connected to the unit before starting up or shutting down (standby) the unit.
- Do not use headphones when starting up or shutting down (standby) the unit. Otherwise, a large noise would cause damage to headphones or your ears.

Starting up the unit

To start up the unit from the stopped state, press and hold the $\odot/1$ button until TASCAM DR-60DMKII (start-up screen) is displayed on the display. The Home Screen appears when the unit starts up.



Start-Up Screen



Home Screen

CAUTION

When the unit is started up for the first time (or when the built-in clock is reset after being left unused without batteries), the DATE/TIME screen appears before the start-up screen to adjust the date and time. (See “Setting the date and time” on page 26.)



Shutting down (putting the unit in standby)

Press and hold the $\odot/1$ button until LINEAR PCM RECORDER appears on the display.

The power turns off after the unit completes its shutdown (standby) process.



CAUTION

Always use the $\odot/1$ button to shutdown (standby) the unit. Do not remove the batteries or disconnect the power cable (AC adaptor TASCAM PS-P515U or USB cable) accidentally while the unit is operating. If you do so, the unit cannot shut down properly and all recordings, settings and other data will be lost. Lost data cannot be restored.

3 – Preparation

Resume function

The unit has resume function. When started up, the unit is located to the position (time) where it left off when shut down previously.

If the **Playback (▶)** button is pressed after start-up, the file the unit was playing when shut down (standby) previously starts to be played from the position (time) where the unit left off when shut down.

NOTE

The required data are stored in the SD card. The resume function does not work if the card is exchanged or formatted.

Setting the date and time

Using its internal clock, this unit remembers the date and time when a file is recorded.

1. Press the **MENU** button to open the **MENU** screen.

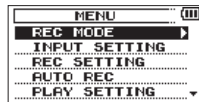

2. Turn the **DATA** dial to select **OTHERS**, and press the **DATA** dial or **▶▶** button to open the **OTHERS** screen.



The **OTHERS** screen opens.

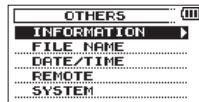

- Turn the **DATA** dial to select **DATE/TIME**, and press the **DATA** dial or **▶▶** button.

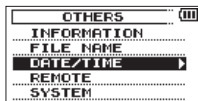

The **DATE/TIME** screen opens.



- Press the **DATA** dial or the **◀◀** and **▶▶** buttons to move the cursor, and turn the **DATA** dial to change the value.
- Press the **MENU** button or **◀◀** button to confirm the change and return to the **OTHERS** screen.

NOTE

You can set the unit to automatically add the date to file names. (See “Setting the format of file names” on page 78.)

CAUTION

- The date and time setting can only be maintained for a few minutes if the battery power becomes low and the unit is not powered by a TASCAM PS-P515U AC adaptor (sold separately) or USB cable. When using batteries, replace them before they completely lose power.

Inserting and removing SD cards

Inserting the SD card

- Open the SD card slot/USB port cover on the right side of the unit.
- Insert the SD Card into the slot as shown in the following illustration until it clicks into place.

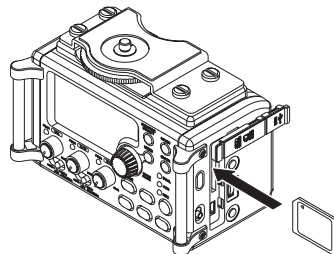

Removing the card

- Open the SD card slot/USB port cover on the right side of the unit.

3 – Preparation

2. Press the SD card in gently and then release it to allow it to come out.

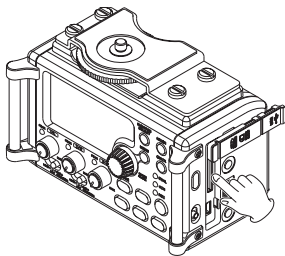

CAUTION

- Do not remove the SD card from the unit during recording, playback or at other times when it is being accessed.
- Do not remove the SD card from the unit when it is connected to a computer by USB.
- SD cards that meet SD or SDHC standards can be used with this unit.
- A list of SD cards that have been confirmed to work with this unit can be found on the TEAC Global Site (<http://teac-global.com/>).

SD card write protection switches

SD cards have protect switches that prevent writing new data to them.

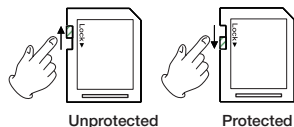

If you slide the protect switch to the **LOCK** position, file recording and editing is not possible. Move the switch to the unlocked position in order to record, erase and otherwise edit data on the card.

Preparing an SD card for use

In order to use an SD card in this unit, you must format it first.

CAUTION

- When formatting a card, the unit should be operating on AC power supplied through the PS-P515U adaptor (sold separately), USB bus power supplied from a computer, or batteries with sufficient remaining power.
 - Formatting a card erases all the data on it.
1. Confirm that an SD card is installed and turn the power ON.
 2. The following confirmation pop-up message appears when a new card or a card formatted for use with another device is installed in the unit.

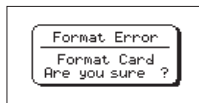

3. Press the **DATA** dial to start formatting.
4. When formatting ends, the Home Screen opens. You can also reformat the card in this unit at any time.

Camera connection and attachment

In order to output the sound from this unit to a DSLR camera and monitor sound from the camera with this unit, you must connect them with commercially-available 3.5mm stereo mini plug cables.

1. If you want to record audio from this unit with a camera, connect the **CAMERA OUT (LOW)** jack on the left side of this unit with the external mic input on the camera.

If you want to input audio from the camera and monitor it with this unit, connect the **CAMERA IN** jack on the left side of this unit with the audio output jack on the camera.

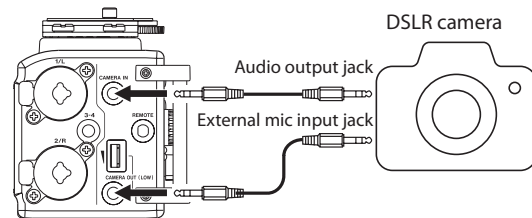

NOTE

Refer to the camera's operation manual for information about the connector on the camera.

2. Use the **CAMERA OUT (LOW)** volume control on the left side of the unit to adjust the level output to the camera.

NOTE

If the output is not loud enough even when the **CAMERA OUT (LOW)** volume is set as high as possible, connect it to the **CAMERA OUT (HIGH)/LINE OUT** jack, and use the **CAMERA OUT (HIGH)/LINE OUT** volume to adjust the output level.

3. To monitor the camera audio input to this unit using headphones, turn monitoring on using the **MONITOR** item on the **REC SETTING** screen. (See "Enabling monitoring" on page 30.)
4. To mount the camera on this unit, use the camera attachment screw on the top of the unit.

3 – Preparation

Connecting monitors and headphones

To listen with headphones, connect them to the **PHONES** jack.
To listen with an external monitoring system (powered monitor speakers or an amplifier and speakers), connect it to the **CAMERA OUT (HIGH)/LINE OUT** jack.

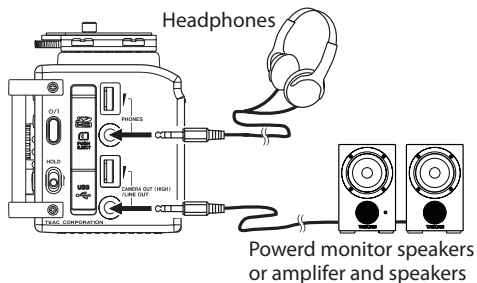

Monitoring

By enabling the monitoring function, you can monitor the input signals when the unit is stopped using headphones, for example. Moreover, by connecting this unit's **CAMERA IN** jack with the camera line output, you can check the sound being recorded by the camera.

Enabling monitoring

1. Press the **MENU** button to open the MENU screen.
2. Turn the **DATA** dial to select **REC SETTING**, and press the **DATA** dial or **▶▶|** button to open the **REC SETTING** screen.
3. Turn the **DATA** dial to select **MONITOR**, and press the **DATA** dial or **▶▶|** button.
4. Turn the **DATA** dial to turn monitoring of the input signal on or off.

Options: OFF, ON (default value)

REC SETTING		()
FORMAT	: WAV 16bit	
SAMPLE	: 44.1k	
SIZE	: 2G < 6h45m	
SELF TMR	: OFF	
MONITOR	: ON	▼

5. When finished, press the **stop** (■) [**HOME**] button to return to the Home Screen.

Selecting the monitored signal

- When the Home Screen is open and the unit is stopped, paused, in recording standby or recording, press the **MONITOR SELECT** button to open a pop-up menu where you can select which signal to monitor.



Stereo recording mode



4-channel recording mode

- Turn the **DATA** dial to select which signal to monitor.

Option	Meaning
MIX	Monitor a mix of channels 1–4.
MIX Main	Monitor the dual recording mode main file.
MIX Sub	Monitor the dual recording mode sub file.
CH12	Monitor a mix of channels 1–2.
CH34	Monitor a mix of channels 3–4.
CAMERA IN	Monitor the CAMERA IN jack signal.
CH1	Monitor the channel 1 input sound.
CH1 Main	Monitor the dual recording mode main file left channel.
CH1 Sub	Monitor the dual recording mode sub file left channel.
CH2	Monitor the channel 2 input sound.
CH2 Main	Monitor the dual recording mode main file right channel.

Option	Meaning
CH2 Sub	Monitor the dual recording mode sub file right channel.
CH3	Monitor the channel 3 input sound.
CH3 Main	Monitor the dual recording mode main file left channel.
CH3 Sub	Monitor the dual recording mode sub file left channel.
CH4	Monitor the channel 4 input sound.
CH4 Main	Monitor the dual recording mode main file right channel.
CH4 Sub	Monitor the dual recording mode sub file right channel.

NOTE

The monitoring options depend on the recording mode setting.

- When finished selecting the monitoring signal, press the **DATA** dial or **MONITOR SELECT** button to return to the Home Screen.

NOTE

*When **CAMERA IN** is selected, you can monitor the input sound through the **PHONES** jack, but the level meters will show the input sound according to the recording mode.*

4 – Recording

This unit can record sound from external microphones and external audio devices, including CD players.

The unit can be set to record audio files in WAV or BWF (44.1/48/96kHz, 16/24-bit) format.

Marks added when recording to Broadcast Wave Format (BWF) can be used with software that supports this format, for example.

This recorder has five recording modes, including dual recording, which allows the same input signals to be recorded at two different levels, and 4-channel recording.

Selecting file format, sampling frequency, and maximum file size

Select the audio file type that you want to record before you start recording.

1. Press the **MENU** button to open the MENU screen.
2. Turn the **DATA** dial to select REC SETTING, and press the **DATA** dial or **▶▶** button to open the REC SETTING screen.

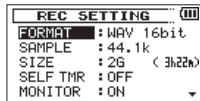

3. Turn the **DATA** dial to select FORMAT, and press the **DATA** dial or **▶▶** button.

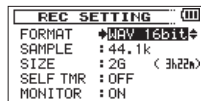

Set the file format with the **DATA** dial to one of the following options.

Options: BWF 16bit, BWF 24bit, WAV 16bit (default value), WAV 24bit

NOTE

BWF is a format created for broadcasting that has the same sound quality as the standard WAV format. It also uses the same “wav” file extension as WAV files. In this manual, we distinguish these file types by using the terms BWF and WAV.

4. Press the **DATA** dial or **◀◀** button to show settings.
5. Turn the **DATA** dial to select SAMPLE, and press the **DATA** dial or **▶▶** button.

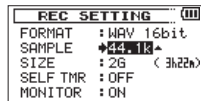

Set the sampling frequency with the **DATA** dial to one of the following options.

Options: 44.1k (default value), 48k, 96k.

6. Press the **DATA** dial or **◀◀** button to show settings.

- Turn the **DATA** dial to select **SIZE**, and press the **DATA** dial or **▶▶** button.

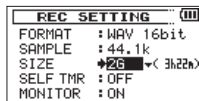

Set the maximum file size with the **DATA** dial to one of the following options.

Options: 64M, 128M, 256M, 512M, 1G, 2G. (default value)

NOTE

- If the maximum set file size is exceeded during recording, the unit will automatically continue recording in a new file.*
 - Depending on the file format, the amount of recording time will differ for the same file size. The amount of recording time is shown on the right of the setting value (in parentheses).*
- When finished making the setting, press the **stop** (■) [**HOME**] button to return to the Home Screen.

Preparing the recording inputs

Connecting microphones

Connect microphones to this unit's **1/L**, **2/R** and/or **3-4** connectors. Point the mics at the sound source and place the unit in a stable location where there is little vibration.

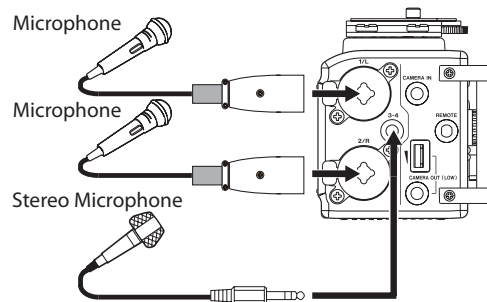

4 – Recording

Recording an external device (LINE IN)

Use stereo plug cables to connect to the output of an external audio device.

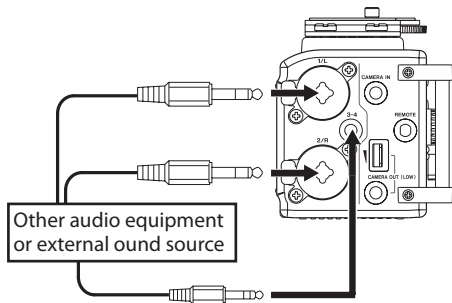

CAUTION

- Reduce the output level of the external audio device if the input sound is distorted even when reducing the input gain level on the unit.
- When an external audio device with a fixed output line level is connected, it would be impossible to control the gain level appropriately because of excessively large input signals. In such cases, use the headphone jack or other level-controllable output for connection to the unit.

Setting the input types

Set the **1/L** and **2/R** input switches on the front of the unit according to the types of equipment connected to them.

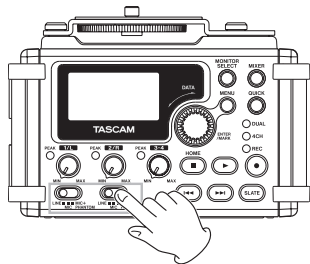

LINE:

Use this setting when connecting line output jacks of external devices to the analog inputs of this recorder.

MIC:

Use this setting when connecting mics to the recorder.

MIC+PHANTOM:

Use this setting when connecting condenser mics that require phantom power (+24V or +48V) to the recorder.

When you set it to **MIC+PHANTOM**, a pop-up message appears confirming that you want to turn phantom power on. (See "Using phantom power" on page 35.)

Use the **SYSTEM** screen to set the voltage to +24V or +48V. (See "Setting the phantom power voltage" on page 76.)

CAUTION

Depending on this setting, the input level setting range changes. For this reason, the input level might change greatly when this setting is changed. Before changing it, you should turn the power OFF or turn the output level all the way down.

Using phantom power

When stopped, if you change the **1/L** or **2/R** input switch on the front of the unit to **MIC+PHANTOM**, a pop-up message appears confirming that you want to turn phantom power on.



When the confirmation pop-up message opens, press the **DATA** dial to turn phantom power on for the **1/L** connector or **2/R** connector and supply phantom power (+24V or +48V) to the connected mic.

To close the confirmation pop-up message without turning phantom power on, change the input switch to **LINE** or **MIC**.

Use the **SYSTEM** screen to set the voltage to +24V or +48V. (See “Setting the phantom power voltage” on page 76.)

NOTE

Battery power will be consumed faster when set to +48V than when set to +24V.

CAUTION

- *Confirm that phantom power is OFF before connecting a line level device to a 1/L connector or 2/R connector. If you connect a line level device while phantom power is being supplied, that device and this unit could be damaged.*
- *When using a condenser microphone, before connecting to and disconnecting from a 1/L connector or 2/R connector, confirm that the phantom power for that jack is OFF. If you connect or disconnect a mic while phantom power is being supplied, that mic and this unit could be damaged.*
- *Turn phantom power ON only when using a condenser microphone that requires phantom power.*
- *Supplying phantom power to some types of ribbon microphones could break them. Do not supply phantom power to a ribbon microphone if you are in doubt.*
- *When using USB bus power, the unit might not be able to supply phantom power depending on the computer. In this case, use a TASCAM PS-P515U AC adaptor (sold separately).*
- *Some condenser microphones will not operate when phantom power is set to +24V.*
- *Do not connect or disconnect the AC adaptor when using phantom power. Doing so could damage this device.*

4 – Recording

Using plug-in power

The plug-in power function can be turned on when an external mic that requires it is connected to the **3-4** jack.

1. Press the **MENU** button to open the MENU screen.
2. Turn the **DATA** dial to select **OTHERS**, and press the **DATA** dial or **▶▶** button to open the **OTHERS** screen.
3. Turn the **DATA** dial to select **SYSTEM**, and press the **DATA** dial or **▶▶** button to open the **SYSTEM** screen.
4. Turn the **DATA** dial to select **PLUGIN POWER**, and press the **DATA** dial or **▶▶** button.

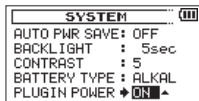

5. Turn the **DATA** dial to turn plug-in power **ON** (default value: **OFF**).
6. When finished making the setting, press the **stop** (■) [**HOME**] button to return to the Home Screen.

CAUTION

- *When connecting a dynamic mic or external mic that has its own battery, set **PLUG IN POWER** to **OFF**. If **ON**, the connected mic could be damaged.*
- *When using a mic to record, use headphones for monitoring. If you use speakers for monitoring, the sound output from the speakers could be picked up by the mic, resulting in its unwanted recording or feedback noise.*

Adjusting the input level/Muting

Before starting recording, the input level should be adjusted to prevent the recorded sounds or signals from being distorted due to excessively large input signals or from being inaudible due to excessively low input signals compared to noise. You can also mute the input.

In addition to manual adjustment, the unit has the following three level adjustment functions: peak reduction, automatic level control, and limiter. Any of these can be used as required. (See “Using the limiter” on page 38.)

TIP

*In addition to adjusting the **INPUT** level, try changing the distance and angle between the microphone and the sound source. The angle and distance of the microphone can also change the character of the recorded sound.*

1. Press the **MENU** button to open the MENU screen.
2. Turn the **DATA** dial to select **INPUT SETTING**, and press the **DATA** dial or **▶▶** button to open the **INPUT SETTING** screen.
3. Turn the **DATA** dial to set the **GAIN** for each channel, and press the **DATA** dial or **▶▶** button.

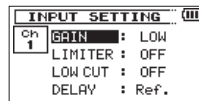

Ch1 INPUT SETTING screen

4. Turn the **DATA** dial to set the mic input gain.
Options: **MUTE**, **LOW** (default value), **MID**, **HIGH**, **HI+PLUS**

NOTE

- Select **MUTE** to mute the mic input.
- Ch3/4 has only two mic input gain options—**LOW** (default value), **HIGH** and **HIGH+PLUS**.
- The **LOW**, **MID** and **HIGH** settings change the input gain, and should be set according to the input level.

If you are not sure which setting to use, try **LOW** first. If the input level is too low even after adjustment, return to the **INPUT SETTING** screen and set it to **MID**. If the input level is still too low after switching to **MID**, switch it to **HIGH**. If the input level is still too low after switching to **HIGH**, switch it to **HI+PLUS**.

- The limiter function can be set and changed even during recording standby and when recording.
5. When finished making the setting, press the **stop** (■) [**HOME**] button to return to the Home Screen.
 6. Press the **record** (●) button to begin recording standby. The record indicator flashes red and the recording screen appears.

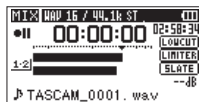

NOTE

MUTE will appear on the Home Screen above the level meters of channels that are muted.



7. Use the **1/L**, **2/R** and **3-4** knobs on the front of the unit to adjust the input levels.

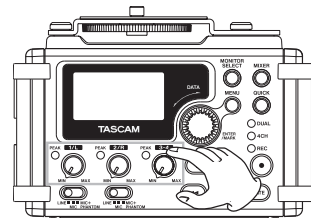

If the input levels are too high, the peak indicators to the left of the **1/L**, **2/R** and **3-4** knobs light red.

A ▼ mark is provided at –12 dB on the level meters. Set the input level so that the indicator bars move to and fro with this mark at about the center without causing the **1/L** knob, **2/R** knob, **3-4** knob **PEAK** indicator to light red when the loudest sounds occur.

CAUTION

During mic input, this lights if distortion occurs in the analog circuitry. During line level input, this does not light even if distortion occurs in the analog circuitry.

NOTE

To monitor the sound while adjusting the input levels or recording, connect headphones to the **PHONES** jack. Use the **PHONES** jack volume control to adjust the monitoring level. Changing the monitoring volume does not affect the recorded sound.

8. When finished making the setting, press the **stop** (■) [**HOME**] button to exit recording standby.

4 – Recording

Using the limiter

When the limiter is on, the mic input gain will be adjusted automatically according to the input level to set the recording level so that distortion does not occur even when loud sounds are input.

1. Press the **MENU** button to open the MENU screen.
2. Turn the **DATA** dial to select INPUT SETTING, and press the **DATA** dial or ►► button to open the INPUT SETTING screen.
3. Turn the **DATA** dial to select LIMITER for a channel, and press the **DATA** dial or ►► button.

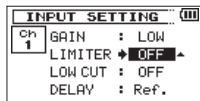

Ch1 INPUT SETTING screen

4. Turn the DATA dial to set the limiter for mic input.

Options	Explanation
OFF (default value)	Limiter off
MONO	Limiter on only for selected channel
LINK	Limiter on for both selected and linked channels

5. When finished making the setting, press the **stop** (■) [HOME] button to return to the Home Screen.

CAUTION

- Distortion might occur if the input sound is too loud even when the limiter is on. In such a case, lower the input level or increase the distance between the unit and the sound source.
- During mic input, this lights if distortion occurs in the analog circuitry. During line level input, this does not light even if distortion occurs in the analog circuitry.

NOTE

- The **LIMITER** icon appears on the recording screen when the limiter is on for any channel (when set to MONO or LINK).
- The limiter function can be set and changed even during recording standby and when recording.
- When you change the 1Ch (2Ch) limiter setting from MONO to LINK the setting of the other channel will be changed to match, so a confirmation pop-up message appears.



Pop-up message when changing from MONO to LINK

- The Ch3/4 MONO and LINK limiter settings affect both channels. When set to MONO, the limiter only affects the channel that has excessive input. When set to LINK, the limiter affects both channels in the pair when either has excessive input.

Using the low-cut filter

The low cut filter can reduce noise such as offensive wind noise from air-conditioners and projectors.

1. Press the **MENU** button to open the MENU screen.
2. Turn the **DATA** dial to select **INPUT_SETTING**, and press the **DATA** dial or **▶▶** button to open the **INPUT_SETTING** screen.
3. Turn the **DATA** dial to select **LOW CUT** for a channel, and press the **DATA** dial or **▶▶** button.

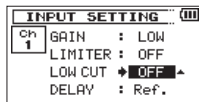

Ch1 INPUT SETTING screen

4. Turn the **DATA** dial to select the cut off frequency of the low cut filter for mic input.
Options: OFF (default value), 40Hz, 80Hz, 120Hz
5. When finished making the setting, press the **stop** (■) [**HOME**] button to return to the Home Screen.

CAUTION

- *The low-cut filter cannot be used with line input.*
- *Use headphones to monitor when you are recording with a microphone. If you use speakers to monitor, the sound output from the speakers may also be recorded, causing a poor recording and even feedback.*

NOTE

The low-cut function can be set and changed even during recording standby and when recording.

Set where to save the file

Set the folder where recorded files are saved.

The created sound file will be saved in the currently selected folder. For details, see **SELECT** quick menu under “Folder operations” on page 56.

If no setting is made, new recording files are placed in the “MUSIC” folder.

Overview of recording modes

This recorder has five recording modes.

Use the **REC MODE** item on the **REC MODE** screen to set the recording mode.

The settings available are different for each recording mode.

MONO mode

This is a mode for mono recording.

STEREO mode (default value)

This is a mode for stereo recording of two independent left and right channels.

DUAL MONO mode

This mode uses one input source to create files at two different input levels (set on **INPUT_SETTING** screen). Two mono files will be recorded.

DUAL ST mode

4 – Recording

This mode uses one input source to create files that two different input levels (set on INPUT SETTING screen). Two stereo files will be recorded.

4CH mode

This mode records 4 external inputs in two pairs as two stereo files.

Recording (MONO/STEREO recording)

Make recording settings

1. Press the **MENU** button to open the MENU screen.
2. Turn the **DATA** dial to select **REC MODE**, and press the **DATA** dial or **▶▶|** button to open the **REC MODE** screen.
3. Turn the **DATA** dial to select **REC MODE**, and press the **DATA** dial or **▶▶|** button.
4. Turn the **DATA** dial to set it to **MONO** or **STEREO** (default value: **STEREO**).

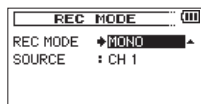

mono recording

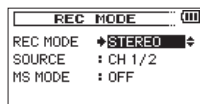

stereo recording

5. Press the **DATA** dial or **◀◀|** button to select the other item.
6. Turn the **DATA** dial to select **SOURCE**, and press the **DATA** dial or **▶▶|** button.

7. Turn the **DATA** dial to select the input source.

REC MODE	SOURCE (options)	Explanation
MONO	CH1	Channel 1 mono recording
	CH2	Channel 2 mono recording
	CH3	Channel 3 mono recording
	CH4	Channel 4 mono recording
STEREO	CH1/2	Channel 1 and 2 stereo recording
	CH3/4	Channel 3 and 4 stereo recording

8. Press the **DATA** dial or **◀◀|** button to select the other item.
9. If **REC MODE** is set to **STEREO**, you can also set **MS mic decoding**.

To use a mid-side mic, turn the **DATA** dial to select **MS MODE**, and press the **DATA** dial or **▶▶|** button.

10. Turn the **DATA** dial to set the decoding mode when using a mid-side mic.

Options	Explanation
OFF	Record in ordinary stereo mode.
REC	Use to decode while recording. Playback is conducted without decoding.
MONITOR	Record mid-side mic output without decoding for decoding later. Use this mode to monitor when recording with a mid-side mic. Use this also when playing back mid-side files that were recorded without decoding.

11. When finished making the setting, press the **stop** (■) **[HOME]** button to return to the Home Screen.

Starting the recording

1. Press the **record** (●) button to begin recording standby.



mono recording



stereo recording

The screen shows the recording file name, the input source, the recording audio file type and sampling frequency. Please confirm that these are as desired before starting recording.

2. To start recording, press the **record** (●) button again.



mono recording



stereo recording

When recording starts, the indicator lights continuously, and the display shows the elapsed recording time and the remaining recording time.

3. Press the **stop** (■) [HOME] button to end recording and create the audio file.

To pause recording, press the **record** (●) button. Press the **record** (●) button or **play** (▶) button again to restart recording in the same file.

If you press the **stop** (■) [HOME] button after pausing a recorded audio file up to the moment that you paused recording is created.

NOTE

To avoid recording of the noise from pressing the record (●) button, the start of recording is delayed by 0.3 second (fixed) after the record (●) button is pressed. (REC DELAY)

File names when recording in MONO/STEREO

TASCAM_0001.WAV

① ②

- ①: Set with the **WORD** item on the **FILE NAME** screen
- ②: Recording file base number

4 – Recording

Simultaneously recording two files at different input levels (DUAL REC)

This recorder can simultaneously record a second recording at a different input level along with the regular recording. For example, when recording with microphones, you can make an ordinary recording with the input level set as high as possible and simultaneously record at a slightly lower input level for safety.

Two recorded files (one with higher input level and one with lower input level) are saved individually

NOTE

Make the input level setting for the ordinary recording in the usual manner (See “Preparing the recording inputs” on page 33 and “Adjusting the input level/Muting” on page 36.).

Enabling dual recording

1. Press the **MENU** button to open the MENU screen.
2. Turn the **DATA** dial to select **REC MODE**, and press the **DATA** dial or **▶▶I** button to open the **REC MODE** screen.
3. Turn the **DATA** dial to select **REC MODE**, and press the **DATA** dial or **▶▶I** button.
4. Turn the **DATA** dial to set it to **DUAL MONO** or **DUAL ST**.

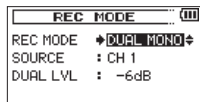

Dual mono recording

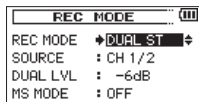

Dual stereo recording

5. Press the **DATA** dial or **I◀◀** button to select the other item.

6. Turn the **DATA** dial to select **SOURCE**, and press the **DATA** dial or **▶▶I** button.
7. Turn the **DATA** dial to select the input source.

REC MODE	SOURCE (options)	Explanation
DUAL MONO	CH1	Channel 1 dual mono recording
	CH2	Channel 2 dual mono recording
	CH3	Channel 3 dual mono recording
	CH4	Channel 4 dual mono recording
DUAL ST	CH1/2	Channel 1/2 dual stereo recording
	CH3/4	Channel 3/4 dual stereo recording

8. Press the **DATA** dial or **I◀◀** button to select the other item.
9. Turn the **DATA** dial to select **DUAL LVL**, and press the **DATA** dial or **▶▶I** button.
10. Turn the **DATA** dial to set the input gain level of the other recording.

Range: 0dB to -12dB (default value: -6dB)

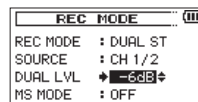

11. Press the **DATA** dial or **I◀◀** button to select the other item.

- If **REC MODE** is set to **DUAL ST**, you can also set **MS** mic decoding.
To use a mid-side mic, turn the **DATA** dial to select **MS MODE**, and press the **DATA** dial or **▶▶** button.
- Turn the **DATA** dial to set the decoding mode when using a mid-side mic.

Options	Explanation
OFF	Record in ordinary stereo mode.
REC	Use to decode while recording. Playback is conducted without decoding.
MONITOR	Record mid-side mic output without decoding for decoding later. Use this mode to monitor when recording with a mid-side mic. Use this also when playing back mid-side files that were recorded without decoding.

- When finished making the setting, press the **MENU** button to return to the **MENU** screen. Press the **DATA** dial or **◀◀** button to select the other item.
- Turn the **DATA** dial to select **INPUT SETTING**, and press the **DATA** dial or **▶▶** button to open the **INPUT SETTING** screen.

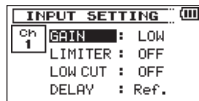

- Turn the **DATA** dial to select **DELAY**, and press the **DATA** dial or **▶▶** button.
- Turn the **DATA** dial to set this value according to the distance of the mic connected to the channel.
Range: 0ms (default value) to ±150ms (in 1ms increments)

- When finished making the setting, press the **stop** (■) [**HOME**] button to return to the Home Screen.

Starting dual recording

Press the **record** (●) button to start dual recording.
During dual recording, the recording screen appears as follows.

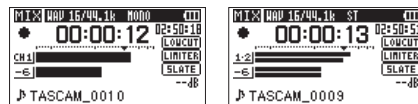

Dual mono recording Dual stereo recording

In the input source display area of the recording screen, the input levels of the current input source and the dual recording are shown.

4 – Recording

Dual recording file names

Dual recording allows two files to be recorded simultaneously. The name of the second file created by dual recording has **DXX** added to the file name of the ordinary recording. **DXX** shows the amount that the input level has been lowered.

TASCAM_0002S12.WAV

① ② ③④

TASCAM_0002S34D12.WAV

① ② ③④ ⑤

- ①: Set with the **WORD** item on the **FILE NAME** screen
- ②: Recording file base number
- ③: 5 is the source file
- ④: Assigned channels (12 is channels 1/2 and 34 is channels 3/4)
- ⑤: This dual recording file was recorded with the input level set to -12dB. (This would be **D06** if recorded at -6dB or **D10** if recorded at -10dB, for example.)

Recording 4 channels

You can connect external mics or other equipment to record four independent channels as two stereo recording files (channels 1/2 and 3/4).

Making 4-channel recording settings

1. Press the **MENU** button to open the **MENU** screen.
2. Turn the **DATA** dial to select **REC MODE**, and press the **DATA** dial or **▶▶|** button to open the **REC MODE** screen.
3. Turn the **DATA** dial to select **REC MODE**, and press the **DATA** dial or **▶▶|** button.
4. Turn the **DATA** dial to select **4CH**.

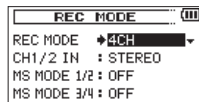

5. Press the **DATA** dial or **◀◀|** button to select the other item.
6. Turn the **DATA** dial to select **CH1/2 IN**, and press the **DATA** dial or **▶▶|** button.

Set the CH1 and CH2 mic inputs.

Options: **STEREO** (default value), **CH1 MUTE**, **CH2 MUTE**

7. Press the **DATA** dial or **◀◀|** button to select the other item.
8. When using mid-side mics, turn the **DATA** dial to select **MS MODE 1/2** or **MS MODE 3/4**, and press the **DATA** dial or **▶▶|** button.

- Turn the **DATA** dial to set the decoding mode when using a mid-side mic.

Options	Explanation
OFF	Record in ordinary stereo mode.
REC	Use to decode while recording. Playback is conducted without decoding.
MONITOR	Record mid-side mic output without decoding for decoding later. Use this mode to monitor when recording with a mid-side mic. Use this also when playing back mid-side files that were recorded without decoding.

- When finished making the setting, press the **MENU** button to return to the MENU screen.
- Turn the **DATA** dial to select **INPUT SETTING**, and press the **DATA** dial or **▶▶** button to open the **INPUT SETTING** screen.

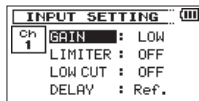

- Turn the **DATA** dial to select **DELAY**, and press the **DATA** dial or **▶▶** button.
- Turn the **DATA** dial to set the value according to the distance between mics.

Range: 0ms (default value) to ±150ms (in 1ms increments)

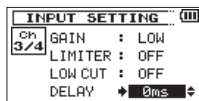

NOTE

- If the mics (channels 1/2 and channels 3/4) are far apart from each other, a time delay could occur when recording. Use the **DELAY** setting to eliminate this time delay when recording.
- The **DELAY** setting can be changed even during recording standby and when recording.

- When finished making the setting, press the **stop** (■) [**HOME**] button to return to the Home Screen.

Starting 4-channel recording

- Press the **record** (●) button to begin recording standby.



NOTE

Before you start recording you can confirm the recording audio file format and sampling frequency at the top of the recording screen, as well as the input sources on the left and the recording project name beneath the meter bars.

- Press the **record** (●) button again to start recording.

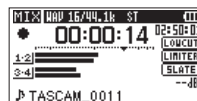

4 – Recording

File names when recording in 4-channel

In 4-channel recording, a set of two files is created—one for the external mics connected to channels 1 and 2 and one for the external device or stereo mic connected to channels 3/4.

TASCAM_0002S12.WAV

① ② ③ ④

TASCAM_0002S34.WAV

① ② ③ ④

- ①: Set with the **WORD** item on the **FILE NAME** screen
- ②: Recording file base number
- ③: S is the source file
- ④: Assigned channels (12 is channels 1/2 and 34 is channels 3/4)

Recording automatically (AUTO REC)

This function allows the unit to respond to input sound levels and start and pause recording, as well as set marks and create new files, for example.

1. Press the **MENU** button to open the **MENU** screen.
2. Turn the **DATA** dial to select **AUTO REC**, and press the **DATA** dial or **▶▶** button to open the **AUTO REC** screen.

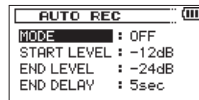

3. Turn the **DATA** dial to select **MODE** and press the **DATA** dial or **▶▶** button.
4. Turn the **DATA** dial to set the automatic recording mode.
 - OFF (default value): Off
 - MARK: Sets marks automatically during recording
 - PAUSE: Automatically pauses during recording
 - TRK INC: Automatically creates new files during recording
5. Press the **DATA** dial or **◀◀** button to select the other item.
6. Turn the **DATA** dial to select **START LEVEL**, and press the **DATA** dial or **▶▶** button.
7. Turn the **DATA** dial to set the start level, which is the level that the unit recognizes as an input signal.
 - Options: -6dB, -12dB (default value), -24dB, -48dB
8. Press the **DATA** dial or **◀◀** button to confirm the setting and return to item selection.
9. Turn the **DATA** dial to select **END LEVEL**, and press the **DATA** dial or **▶▶** button.

- Turn the **DATA** dial to set the **END LEVEL**, which is the level that the unit recognizes as no input signal.
Options: -6dB, -12dB, -24dB (default value), -48dB
- Press the **DATA** dial or **◀◀** button to select the other item.
- Turn the **DATA** dial to select **END DELAY**, and press the **DATA** dial or **▶▶** button.
- Turn the **DATA** dial to set the **END DELAY**, which is the amount of time after the **END LEVEL** is reached until recording stops.
Options: 1sec – 5sec (default value)
- When finished making the setting, press the **stop (■) [HOME]** button to return to the Home Screen.
- Press the **record (●)** button to put the unit into recording standby.
Recording starts automatically when the input signal exceeds the **START LEVEL**.
- The recording mode changes according to the setting of the **MODE**.
 - MARK:** The unit adds marks when the input signal level falls below the **END LEVEL** for more than the **END DELAY** time and when the input signal level becomes higher than the **START LEVEL** again.
 - PAUSE:** The unit pauses recording (resumes recording standby) when the input signal level falls below the **END LEVEL** for more than the **END DELAY** time.
 - TRK INC:** The unit pauses recording (resumes recording standby) when the input signal level falls below the **END LEVEL** for more than the **END DELAY** time. When the input signal level becomes higher than the **START LEVEL** again, it starts recording to a new file.

- Press the **stop (■) [HOME]** button to stop automatic recording.

TIP

*By using this in combination with the **PRE REC** function, you can record events without losing the beginnings of sounds.*

CAUTION

- When the **AUTO REC** function is on the self-timer function cannot be used.
- A new file cannot be created if the total number of folders and files would exceed 5000.
- Files shorter than two seconds cannot be created. Moreover, if the sampling frequency is 96 kHz, files shorter than four seconds cannot be created.
- If the name of a newly created file would be the same as that of an existing file, its number will be increased by one.

NOTE

- You can also add marks manually. (See “Adding marks manually to a recording” on page 49.)
- You can also manually start a new file in the middle of recording. (See “Adding marks automatically to a recording” on page 49.)
- When a new file is created, the number at the end of the filename is increased by one.

4 – Recording

Creating and changeover to a new file during continued recording (Track increment)

You can manually or automatically split a recording by creating a new file. (Track increment)

Manual track increment during recording

You can manually split a recording by creating a new file.

1. Press the ►►I button while recording.

NOTE

When new files are created, incremental numbers are added to the end of each project name.

CAUTION

- A new file cannot be created if the total number of files and folders would exceed 5000.
- Files shorter than two seconds cannot be created. If the sampling frequency is 96kHz, files shorter than four seconds cannot be created.
- If the name of a newly created file would be the same as that of an existing file, the number will be incremented until the new file has a unique name.

Automatic track increment by file size

Without pausing recording, a new file can be created automatically during recording when a file size set in advance is exceeded.

1. Press the **MENU** button to open the MENU screen.
2. Turn the **DATA** dial to select REC SETTING, and press the **DATA** dial or ►►I button to open the REC SETTING screen.
3. Turn the **DATA** dial to select SIZE, and press the **DATA** dial or ►►I button.
4. Turn the **DATA** dial to set the maximum file size at which track increment takes place, by selecting (highlighting) from the following:
Options: 64M, 128M, 256M, 512M, 1G, 2G (default value)

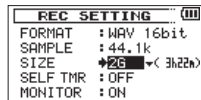

5. When finished making the setting, press the **stop** (■) [**HOME**] button to return to the Home Screen.

CAUTION

A new file cannot be created if the total number of files and folders would exceed 5000.

NOTE

Depending on the file format, the same maximum file size will have different recording lengths.

Mark function

Adding marks manually to a recording

You can manually add marks to a recording where you want them.

1. Press the **DATA** dial while recording to add a mark.
Mark number pull-up appears.



NOTE

- Mark information is stored in the file with numbers between 01–99. The maximum number of marks in a file is 99.
- Marks added to BWF format WAV files by this unit during recording are stored in the file. These marks can be used when playing back the file using software or equipment that supports the BWF format.

Adding marks automatically to a recording

This function allows the unit to add marks automatically using **AUTO REC**.

On the **AUTO REC** screen, set the **MODE** item to **MARK**.

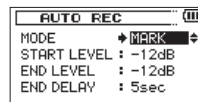

See “Recording automatically (AUTO REC)” on page 46.

Moving to a mark position

You can move to marks in the currently selected file when stopped or playing back.

You can use this function to identify points to create shortcuts to the beginning of songs, for example.

1. Press the **◀◀** or **▶▶** button while pressing and holding the **DATA** dial during playback or when stopped.

NOTE

You cannot move to a mark in a different file.

4 – Recording

Recording the moment before pushing RECORD (PRE REC)

By using prerecording, when the unit is in recording standby you can record up to two seconds of the signal input before the record (●) button is pushed to start recording.(PRE REC)

1. Press the **MENU** button to open the MENU screen.
2. Turn the **DATA** dial to select REC SETTING, and press the **DATA** dial or ►►I button to open the REC SETTING screen.
3. Turn the **DATA** dial to select PRE REC, and press the **DATA** dial or ►►I button.
4. Turn the **DATA** dial to turn the pre-recording function ON (default value: OFF).

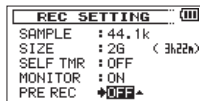

5. When finished making the setting, press the **stop** (■) [HOME] button to return to the Home Screen.

TIP

By using this in combination with the AUTO REC function, you can record events without losing the beginnings of sounds.

NOTE

- If recording is started less than two seconds after entering record standby, the sound since entering recording standby will be recorded.
- If you turn the pre-recording function on, turn the recording delay function off.

Delaying the start of recording (REC DELAY)

You can delay the start of recording by about 0.3 seconds (fixed time) from when you press the **record** (●) button.

Use this function to avoid recording the sound of pressing the **record** (●) button.

1. Press the **MENU** button to open the MENU screen.
2. Turn the **DATA** dial to select REC SETTING, and press the **DATA** dial or ►►I button to open the REC SETTING screen.
3. Turn the **DATA** dial to select REC DELAY, and press the **DATA** dial or ►►I button.
4. Turn the **DATA** dial to set the recording delay function to ON (default value: OFF).

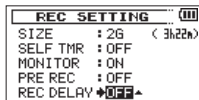

5. When finished making the setting, press the **stop** (■) [HOME] button to return to the Home Screen.

NOTE

If you turn the recording delay function on, turn the pre-recording function off.

Self-timer function

Like a camera, the unit has a self-timer to trigger the start of recording after a set period of time.

1. Press the **MENU** button to open the MENU screen.
2. Turn the **DATA** dial to select **REC SETTING**, and press the **DATA** dial or **▶▶** button to open the **REC SETTING** screen.
3. Turn the **DATA** dial to select **SELF TIMER**, and press the **DATA** dial or **▶▶** button.
4. Turn the **DATA** dial to set the amount of time until recording starts.

Options: OFF (default value), 2sec, 10sec

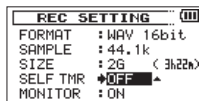

5. When finished making the setting, press the **stop** (■) [**HOME**] button to return to the Home Screen.
6. Press the **record** (●) button to enter recording standby. The self-timer icon  appears in the recorder status screen, and time is shown on the right.
7. Press the **record** (●) or **play** (▶) button. Recording will start after the set time period.

NOTE

- This function cannot be used when recording is paused in the middle of recording.
- Self-timer function is not possible when using the **AUTO REC** function.

Using the auto tone function

The auto tone function can be used to automatically add a tone at the beginning and ending of recording.

By connecting the **CAMERA OUT (LOW)** jack on the left side of the unit to the audio input of a camera, you can record the same tone in both files. These tones can be used to align audio and video recordings in media editing software.

NOTE

*If the output is not loud enough even when the **CAMERA OUT (LOW)** volume is set as high as possible, connect it to the **CAMERA OUT (HIGH)/LINE OUT** jack, and use the **CAMERA OUT (HIGH)/LINE OUT** volume to adjust the output level.*

Setting the auto tone function

1. Press the **MENU** button to open the MENU screen.
2. Turn the **DATA** dial to select **REC SETTING**, and press the **DATA** dial or **▶▶** button to open the **REC SETTING** screen.
3. Turn the **DATA** dial to select **AUTO TONE**, and press the **DATA** dial or **▶▶** button.
4. Turn the **DATA** dial to set when the tone signal is inserted.

Options: OFF (default value), HEAD (start of recording only), HEAD+TAIL (both start and end of recording)

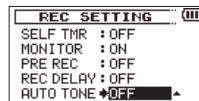

5. When finished making the setting, press the **stop** (■) [**HOME**] button to return to the Home Screen.

4 – Recording

Setting auto tone length

You can set the length of the auto tone.

1. Press the **MENU** button to open the **MENU** screen.
2. Turn the **DATA** dial to select **REC SETTING**, and press the **DATA** dial or **▶▶I** button to open the **REC SETTING** screen.
3. Turn the **DATA** dial to select **TONE SECS**, and press the **DATA** dial or **▶▶I** button.
4. Turn the **DATA** dial to set the length of the tone.
Options: 0.5sec, 1sec (default value), 2sec, 3sec

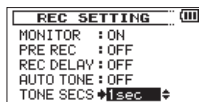

5. When finished making the setting, press the **stop** (■) [**HOME**] button to return to the Home Screen.

Adjusting the volume of the auto tone and the slate tone

You can adjust the volume of the auto tone and the slate tone.

1. Press the **MENU** button to open the **MENU** screen.
2. Turn the **DATA** dial to select **REC SETTING**, and press the **DATA** dial or **▶▶I** button to open the **REC SETTING** screen.
3. Turn the **DATA** dial to select (highlight) the **TONE VOL** item for the channel you want to mute, and press the **DATA** dial or **▶▶I** button.



4. Turn the **DATA** dial to set the tone volume.
Options: -12dB, -18dB(default), -24dB, -30dB, -36dB
5. When finished making the setting, press the **Stop** (■) [**HOME**] button to return to the Home Screen.

Adding slate tones

When enabled, you can press the **SLATE** button on the front of the unit during recording to add a slate tone whenever you like to the recording file.

The **SLATE** button is disabled by default in order to prevent accidental operation. Follow the procedures below to enable the **SLATE** button.

For details about connecting a DSLR camera to this unit, see “Camera connection and attachment” on page 29.

1. Press the **MENU** button to open the **MENU** screen.
2. Turn the **DATA** dial to select **REC SETTING**, and press the **DATA** dial or **▶▶I** button to open the **REC SETTING** screen.
3. Turn the **DATA** dial to select **SLATE KEY**, and press the **DATA** dial or **▶▶I** button.
4. Turn the **DATA** dial to enable the **SLATE** button.
Options: **DISABLE** (default value), **ENABLE**



5. When finished making the setting, press the **stop** (■) [HOME] button to return to the Home Screen.

NOTE

To prevent accidental operation, the SLATE button will not function if pressed continuously.

Recording duration

The table below shows the maximum recording time on SD/SDHC cards of different capacities for different file formats for recording.

File format (recording setting)		SD/SDHC card capacity (hours:minutes)			
		1GB	2GB	4GB	8GB
WAV/BWF 16bit (STEREO)	44.1kHz	1:41	3:22	6:44	13:28
	48kHz	1:33	3:06	6:12	12:24
	96kHz	0:46	1:33	3:06	6:12
WAV/BWF 24bit (STEREO)	44.1kHz	1:07	2:15	4:30	9:00
	48kHz	1:02	2:04	4:08	8:16
	96kHz	0:31	1:02	2:04	4:08

- The recording times shown above are estimates. They might differ depending on the SD/SDHC card in use.
- The recording times shown above are not continuous recording times, but rather they are the total possible recording times for the SD/SDHC card.
- If recorded in mono in WAV files, the maximum recording time will be double the figures above.
- For dual and 4-channel recording in WAV/BWF format, the recording times are about half those shown above.

5 – Working with Files and Folders (BROWSE screen)

On the **BROWSE** screen, you can view the contents of the **MUSIC** Folder, which contains the audio files, on the SD card.

TIP

*If you connect the DR-60DMKII with a computer by USB, or mount the SD card on a computer using a card reader or other input, you can change the folder structure within the **MUSIC** Folder and erase files from the computer as you would the contents of a hard drive. Furthermore, you can change file names from the computer.*

To open the **BROWSE** Screen, press the **MENU** button to open the **MENU** screen. Turn the **DATA** dial to select **BROWSE**, and press the **DATA** dial or **▶▶|** button.

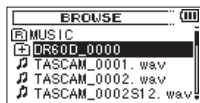

The contents of the folder that contains the file that was selected on the Home Screen before the **BROWSE** Screen was opened appears on the display.

Screen navigation

On the **BROWSE** Screen, folders and music files appear in a hierarchical structure much like they would appear on a computer. On the DR-60DMKII, folders can only be used to two levels.

- Turn the **DATA** dial to select files and folders.
- When a folder is selected, press the **▶▶|** button to show the contents of that folder.

- When a file or folder is selected, press the **◀◀|** button to exit the currently open folder and go to a higher level in the folder structure.

- When a file or folder is selected, press the **QUICK** button to open the quick menu pop-up window.

- When a file is selected, press the **DATA** dial to return to the Home Screen and play that file.

This folder that contains this file becomes the current folder, and new recorded file will be saved in this folder. If the playback area has been set to **FOLDER**, this folder becomes the new playback area.

- When a file is selected, press the **▶▶|** button to load that file and return to the Home Screen.

The folder that contains this file becomes the current folder, and new recorded files will be saved in this folder. If the playback area has been set to **FOLDER**, this folder becomes the new playback area.

- When a folder is selected, press the **DATA** dial to return to the Home Screen. The first file in the folder (shown at the top of the file list) will be played.

This folder becomes the current folder, and new recorded files will be saved in this folder. Regardless of the previous setting, the playback area is set to **FOLDER**, and this folder becomes the new playback area.

5 – Working with Files and Folders (BROWSE screen)

Icons on the BROWSE screen

The meanings of icons that appear on the BROWSE Screen are as follows.

Root Music Folder (MUSIC)

The MUSIC Folder is the highest (root) level folder in the hierarchy shown on the BROWSE Screen.

Audio file

This icon appears before the names of music files.

Plus folder

This icon shows folders that contain subfolders.

Plain folder

This icon shows folders that do not contain subfolders.

Open folder

The contents of the folder marked with this icon currently appear on this screen.

New folder

Create a new folder.

File operations

Select the desired audio file on the BROWSE screen, and press the **QUICK** button to open the quick menu pop-up window shown below.



Turn the **DATA** dial to select the item you want from the following list and press **DATA** dial to execute it.

INFO

Information (date/time, size) about the selected file appears. Press the **DATA** dial again or press the **stop** (■) [HOME] button to return to the BROWSE screen.



5 – Working with Files and Folders (BROWSE screen)

DELETE

A message appears to confirm that you want to delete the selected file.

Press the **DATA** dial to erase the file and the **stop** (■) [**HOME**] button to cancel the deletion operation.



NOTE

If the currently selected file was recorded using dual-recording or four-channel recording, both files recorded at that time will be deleted.

CANCEL

The operation for the selected (highlighted) file is canceled, and the quick menu is closed.

NOTE

The quick menu can also be closed by pressing the QUICK button.

Folder operations

Select the desired folder on the BROWSE screen, and press the **QUICK** button to open the quick menu pop-up window shown below.

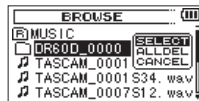

Turn the **DATA** dial to select the item you want from the following list and press the **DATA** dial to execute it.

SELECT

Returns to the Home Screen and selects the first file in the folder. Regardless of the previous setting, the playback area is set to **FOLDER**, and this folder becomes the new playback area. When recording, files are created in this folder.

ALL DEL

A pop-up message appears to confirm that you want to delete all the files in the selected folder at once.

Press the **DATA** dial to erase the files or press the **stop** (■) [**HOME**] button to cancel.

NOTE

You cannot erase read-only files and files that are not recognized by this unit.

5 – Working with Files and Folders (BROWSE screen)

CANCEL

The operation for the selected (highlighted) file is canceled, and the quick menu is closed.

NOTE

The quick menu can also be closed by pressing the QUICK button.

Creating a new folder

In the file list, **NEW FOLDER** appears at the bottom.

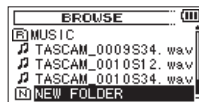

Select (highlight) **NEW FOLDER**, and press the **DATA** dial or ►► button. A pop-up appears to confirm that you want to create a new folder.



Press the **DATA** dial to create a new folder or press the **stop** (■) [**HOME**] button to cancel.

Note that the unit supports only a two-level folder structure, and accordingly **NEW FOLDER** does not exist in the second-level folders. A newly created folder becomes the current one, and new recorded files are saved in this folder. If the playback area has been set to **FOLDER**, this folder becomes the playback area.

6 – Playback

On the Home Screen, you can use the **◀◀** and **▶▶** buttons to select the playback file. The files that you can select are determined by the playback area setting.

Limiting the playback area makes file selection easier when you have numerous recorded and copied files on the SD card.

On the **PLAY SETTING** screen, you can set the play area to **ALL FILES** on the SD card or the current **FOLDER**. You can also use the **BROWSE** Screen to set a folder as the playback area.

NOTE

*On the **BROWSE** Screen, regardless of the playback area setting, you can select any file on the SD card that you want.*

Adjusting playback volume

Use the **PHONES** and **CAMERA OUT (HIGH)/LINE OUT** volume controls to adjust the levels output from the **PHONES** and **CAMERA OUT (HIGH)/LINE OUT** jacks.

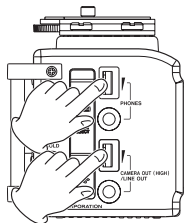

Setting the playback area (AREA)

Set the playback area for repeat and ordinary playback on the **PLAY SETTING** screen.

1. Press the **MENU** button to open the **MENU** screen.
2. Turn the **DATA** dial to select **PLAY SETTING**, and press the **DATA** dial or **▶▶** button to open the **PLAY SETTING** screen.

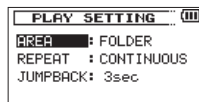

3. Turn the **DATA** dial to select **AREA**, and press the **DATA** dial or **▶▶** button.

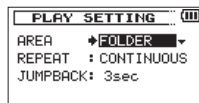

4. Turn the **DATA** dial to set the playback area.
ALL FILES
Set the playback area as all files in the Music Folder on the SD card.
FOLDER (default value)
Set the playback area as all the files in the currently selected folder.

- When finished making the setting, press the **stop** (■) [HOME] button to return to the Home Screen.

NOTE

The current playback area setting appears in the upper left of the Home Screen.

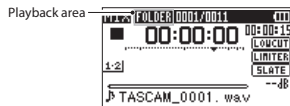

Selecting a folder for the playback area (1)

Regardless of the current playback area, if you select a folder on the BROWSE Screen, the playback area changes to the selected folder.

- Press the **MENU** button to open the MENU screen.
- Turn the **DATA** dial to select BROWSE, and press the **DATA** dial or ►► button to open the BROWSE screen.

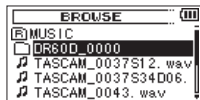

A file list of the folder that contains the file selected in the Home Screen is displayed.

- Use the ◀◀ or ►► button to select a folder level, and turn the **DATA** dial to select a folder.

For an explanation of how to use the BROWSE Screen, see “Screen navigation” on page 54.

- Press the **QUICK** button to open the following quick menu pop-up window.

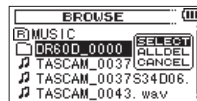

Turn the **DATA** dial to select SELECT, and press the **DATA** dial. The display returns to the Home Screen. The first file in the folder is selected, and the unit is stopped.

Regardless of the previous setting, the playback area is set to FOLDER, and this folder becomes the playback area. This folder becomes the current folder, and new recorded files will be saved in this folder.

6 – Playback

Selecting a folder for the playback area (2)

When the playback area is set to FOLDER, if you select a file on the BROWSE Screen, the folder that contains the selected file becomes the playback area.

1. Press the **MENU** button to open the MENU screen.
2. Turn the **DATA** dial to select BROWSE, and press the **DATA** dial or **▶▶** button to open the BROWSE screen.

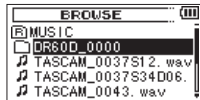

A file list of the folder that contains the file selected in the Home Screen is displayed.

3. Use the **◀◀** or **▶▶** button to select a folder level, and turn the **DATA** dial to select the folder that contains the file you want to play.
For an explanation of how to use the BROWSE Screen, see “Screen navigation” on page 54.
4. Press the **DATA** dial or **▶▶** button.
5. Turn the **DATA** dial to select the desired file.

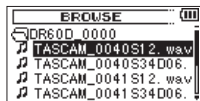

6. Press the **DATA** dial to return to the Home Screen and start playback of the selected file. This folder becomes the current folder, and new recorded files will be saved in this folder.
In addition, the folder that contains this file becomes the playback area regardless of the playback area folder set previously.

Selecting files for playback (skip)

When the Home Screen is open, press the **◀◀** and **▶▶** buttons to select the file for playback.

If you press the **◀◀** button when the playback position is located at the middle of a file, it will return to the beginning of that file. If you press the **◀◀** button when located at the beginning of a file, the playback position will skip to the beginning of the previous file.

If you press the **▶▶** button when located at the beginning of or middle of a file, the playback position will skip to the beginning of the next file.

NOTE

- Only files in the playback area that is currently set can be selected for playback.
- The file name, file number and other file information for the currently playing file appear on the display.
- The **■** icon appears on the display when playback is stopped at the beginning of a file, and the **||** icon appears when playback is stopped in the middle of a file (paused).
- To change files, press the **◀◀** or **▶▶** button as many times as necessary.

Playback

When the Home Screen is open and playback is stopped, press the **play** (▶) button to start playback.

NOTE

- Files in the playback area can be played.
- You can also choose files for playback by name on the BROWSE screen.

Pausing

When the Home Screen is open and a file is playing back, press the **stop** (■) [HOME] button to pause playback at the current position. Press the **play** (▶) button again to restart playback from that position.

Stopping

When the Home Screen is open and a file is playing back, press the **stop** (■) [HOME] button to pause playback, and press the **stop** (■) [HOME] button to return to the beginning of the file.

Rewinding and fast-forwarding (search)

When the Home Screen is open and a file is playing back or stopped, press and hold the ◀◀ or ▶▶ button to rewind or fast-forward and search the playback file.

NOTE

Press and hold the ◀◀ or ▶▶ button to accelerate the search speed.

Changing the playback position

When the Home Screen is open and playback is stopped or paused, turn the **DATA** dial to change the playback position. Playback will be paused after the position is changed.

Repeat playback (REPEAT)

You can repeatedly playback one file or multiple files within a designated area.

1. Press the **MENU** button to open the MENU screen.
2. Turn the **DATA** dial to select **PLAY SETTING**, and press the **DATA** dial or ▶▶| button to open the **PLAY SETTING** screen.
3. Turn the **DATA** dial to select **REPEAT**, and press the **DATA** dial or ▶▶| button.

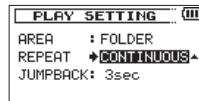

4. Turn the **DATA** dial to select a repeat mode.
 - CONTINUOUS** (default value):
All files in the playback area are played in sequence one time. (This setting is the ordinary playback mode.)
 - SINGLE**:
The selected file is played once without repeating. The ♪ icon appears on the Home Screen.
 - 1 REPEAT**:
The current file is played repeatedly. The ♪ icon appears on the Home Screen.

6 – Playback

ALL REPEAT:

All files in the selected playback area are played back repeatedly. The  icon appears on the Home Screen.

- When finished making the setting, press the **stop** (■) [HOME] button to return to the Home Screen.

Moving back a few seconds for replay (jump-back playback)

Press the **play** (▶) button during playback to move back a few seconds (adjustable) and restart playback. (Jump-back playback).

If you find a favorite passage of music or lyrics during playback, press the **play** (▶) button to go back a few seconds and replay that passage.

The jump-back time is set as a JUMPBACK setting.

- Press the **MENU** button to open the MENU screen.
- Turn the **DATA** dial to select PLAY SETTING, and press the **DATA** dial or ▶▶| button to open the PLAY SETTING screen.
- Turn the **DATA** dial to select JUMPBACK, and press the **DATA** dial or ▶▶| button.

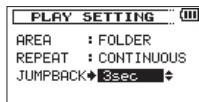

- Turn the **DATA** dial to set the jumpback time in seconds.
Options: OFF, 1sec – 10sec, 20sec, 30sec (default value: 3sec)
- When finished making the setting, press the **stop** (■) [HOME] button to return to the Home Screen.

Playback of files recorded using dual recording

When playing back a file that has been made using dual recording, the track status display is shown as light letters on a dark background.

Press the **MONITOR SELECT** button during playback to switch between monitoring of the two files created using dual recording.

NOTE

*Press the **MONITOR SELECT** button to find the files by the first 11 characters of file names. If file names are changed, this function will not work.*

7 – QUICK button operations

Features of the QUICK button

The **QUICK** button serves for the following purposes.

- When the Home Screen is open and the unit is stopped or paused, press this button to open the quick menu pop-up window where you can delete or divide the current file, use the level alignment function, which increases the overall sound pressure, use the playback equalizer and set the mic input gain.



Quick menu when stopped or paused

During playback, the quick menu pop-up window includes level alignment, playback EQ settings.

When in recording standby or recording, the quick menu pop-up window includes mic input gain settings.



Quick menu during playback on the Home Screen

- On the **BROWSE** screen, the quick menu pop-up window includes operations for the selected file or folder. (See “File operations” on page 55 and “Folder operations” on page 56.)



- On the **MIXER** screen, the quick menu pop-up window includes mic input gain settings.



NOTE

*The **QUICK** button does nothing when the MENU, OTHERS, REC SETTING and other setting screens are open.*

Actions of the **QUICK** button for different screens and states are as follows.

Screen	State	Quick menu contents
Home Screen	Stop/ Pause	Delete/divide file, level align, playback EQ and mic input gain
	Playback	Level align, playback EQ and mic input gain
	Recording Standby/ Recording	Mic input gain
BROWSE screen		Operations for the selected file or folder

7 – QUICK button operations

Screen	State	Quick menu contents
MENU screen, OTHERS screen, Other settings screens		No function
MIXER screen		Mic input gain

Opening the quick menu

When the Home Screen is open, press the **QUICK** button to open the quick menu pop-up window.

The contents of this screen depend on the state of the unit at the time when the **QUICK** button is pressed.

- When the Home Screen is open and the unit is stopped or paused, the following functions can be selected.

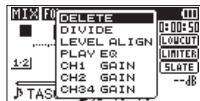

Quick menu when stopped or paused

DELETE:

The current file can be deleted. (See “Deleting the selected file (Quick Delete)” on page 65.)

DIVIDE:

The current file can be divided. (See “Dividing the selected file (DIVIDE)” on page 65.)

LEVEL ALIGN:

The perceived overall sound pressure can be increased to enhance listenability. (See “Increasing the perceived overall sound pressure to enhance listenability (Level Alignment)” on page 67.)

PLAY EQ:

Choose an EQ setting that you like to make the playback sound better. (See “Using the playback equalizer” on page 68.)

CH1 GAIN, CH2 GAIN, CH34 GAIN:

Use to set the mic input gain for that input. (See “Setting mic input gain with the quick menu” on page 68.)

- When the Home Screen is open during playback, the level alignment and playback EQ functions can be selected.



Quick menu during playback on the Home Screen

- When the Home Screen is open in recording standby or when recording, the quick menu pop-up window includes mic input gain settings. (See “Setting mic input gain with the quick menu” on page 68.)



Quick menu when recording or in recording standby

Closing the quick menu

Press the **QUICK** button to close the quick menu pop-up window.

Deleting the selected file (Quick Delete)

The currently selected file can be deleted without using the **BROWSE** screen.

1. To delete a file, select it using the **I◀◀** or **▶▶I** button.
2. Open the Quick menu screen by pressing the **QUICK** button while the Home Screen is open when stopped.
3. Turn the **DATA** dial to select **DELETE**.

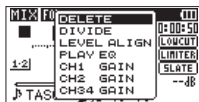

4. Push the **DATA** dial to open a pop-up message confirming deletion of the file.



5. Push the **DATA** dial to delete the file and return to the Home Screen. Push the **stop** (■) [**HOME**] button to cancel deletion and return to the Home Screen.

NOTE

If the currently selected file was recorded using dual-recording or four-channel recording, both files recorded at that time will be deleted.

Dividing the selected file (DIVIDE)

A recorded file can be divided into two at a specified position.

1. Select a file to be divided using the **I◀◀** or **▶▶I** button or the **BROWSE** screen.
2. While the Home Screen is open when stopped, press the **QUICK** button to show the Quick menu screen.
3. Turn the **DATA** dial to select **DIVIDE**.



4. Press the **DATA** dial to open the **DIVIDE** screen.



5. Turn the **DATA** dial to set the position for file division, and press the **record** (●) button.

The following confirmation pop-up message appears.

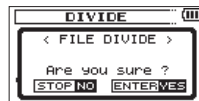

7 – QUICK button operations

6. Press the **DATA** dial to divide the file and return to the Home Screen.
Or press the **stop** (■) [**HOME**] button to return to the **DIVIDE** screen without dividing the file.

NOTE

- When the **DIVIDE** screen is open, you can press the **play** (▶) button and set the divide position while playing the file.
- When the **DIVIDE** screen is open, you can use the **play** (▶) button for playback, the **stop** (■) [**HOME**] button to pause, the **⏮** button to jump to the beginning of a file and the **⏭** button to jump to the end of a file. You can also turn the **DATA** dial to make fine adjustments to the divide position.
- After dividing a file, two new files with “a” and “b” added to the end of the original file name are created.

(4-channel recording file example)

File names before dividing

TASCAM_0003S12.wav

TASCAM_0003S34.wav

File names after dividing

TASCAM_0003aS12.wav (part before division point)

TASCAM_0003aS34.wav (part before division point)

TASCAM_0003bS12.wav (part after division point)

TASCAM_0003bS34.wav (part after division point)

- If the currently selected file was made using dual-recording or four-channel recording, both files recorded at that time will be divided.

CAUTION

- If the SD card has insufficient open space, division might not be possible.
- Division is not possible if the file name would become more than 200 characters long.
- Division is not possible if a file that already exists has the same name as the name that would be given to a new file created by division.

TIP

Add marks during recording at positions where you want to divide a file. (See “Mark function” on page 49.)

Increasing the perceived overall sound pressure to enhance listenability (Level Alignment)

If the playback sound is very small and indiscernible, the perceived overall sound pressure can be increased to enhance listenability. (Level Alignment)

1. When the Home Screen is open and the unit is stopped or playing back, press the **QUICK** button to open the quick menu pop-up.
2. Turn the **DATA** dial to select LEVEL ALIGN.



When stopped



During playback

3. Press the **DATA** dial to open a pop-up menu where you can turn the level align function on or off.



When stopped

4. Turn the **DATA** dial to select **ON**, and press the **DATA** dial to confirm the setting and return to the Home Screen (default value: **OFF**).

When on, the **LVL.A** icon appears on the Home Screen during playback.

When off, the **LVL.A** icon appears on the Home Screen during playback.

NOTE

The level alignment function may not be able to achieve sufficient effect depending on the source of the sound.

7 – QUICK button operations

Using the playback equalizer

You can select an equalizer setting that makes playback sound better to you.

1. When the Home Screen is open and the unit is stopped or playing back, press the **QUICK** button to open the quick menu pop-up.
2. Turn the **DATA** dial to select **PLAY EQ**.



When stopped



During playback

3. Press the **DATA** dial to open a pop-up menu where you can set the playback equalizer.

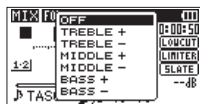

When stopped

4. Turn the **DATA** dial to select the playback equalizer setting that you want to use, and press the **DATA** dial to turn the equalizer on and return to the home screen (default value: OFF).

When on, the **EQ** icon appears on the Home Screen during playback.

When off, the **EQ** icon appears on the Home Screen during playback.

Setting mic input gain with the quick menu

1. Press the **QUICK** button when stopped, paused, in recording standby or recording on the Home Screen or when the **MIXER** screen is open to show the quick menu.

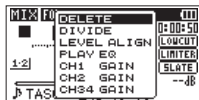

2. Turn the **DATA** dial to select the mic input gain setting for the desired channel, and press the **DATA** dial to open the mic input gain pop-up menu.

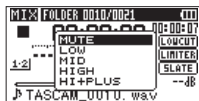

3. Turn the **DATA** dial to select the mic input gain setting, and press the **DATA** dial to set it.
4. Press the **QUICK** button to return to the previous screen.

NOTE

*If you change the mic input gain setting using the quick menu, the **GAIN** item on the **SETTINGS** screen will also be changed.*

This recorder has a mixer function that allows you to set the stereo balance and volume level for each channel.

Making mixer settings

- From the Home Screen, press the **MIXER** button to open the MIXER screen.



Mono/dual mono mode

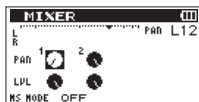

Stereo/dual stereo mode

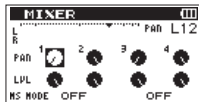

4-channel mode

- Turn the **DATA** dial to select the item you want to change.

- Press the **DATA** dial to open the setting name and value in a pop-up window at the top right.

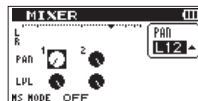

- Turn the **DATA** dial to change the setting value.

Item	Setting range	Operation details
PAN	L12–C–R12	Adjusts left-right balance (L12 (left)–C (center)–R12 (right))
LVL	0–100	Volume level (0 (min.)–100 (max.))
MS MODE	OFF	Record in ordinary stereo mode.
	REC	Use to decode while recording. Playback is conducted without decoding.
	MON	Record mid-side mic output without decoding for decoding later. Use this mode to monitor when recording with a mid-side mic. Use this also when playing back mid-side files that were recorded without decoding.

8 – Mixer

5. Press the **DATA** dial to return to the previous screen where you can select the next setting that you want to adjust.

NOTE

- *The mixer can be used when the unit is stopped, paused, playing back, in recording standby and recording.*
- *Even when the MIXER screen is open, you can use the play (▶) button to start playback and the stop (■) [HOME] button to pause playback.*
- *If the MS MODE item is changed, it will also be changed on the REC MODE screen.*
- *The MS MODE cannot be changed when recording.*

Using the MS decoder

When using MS mics to record, you have two decoding options. You can decode the input sound as you record or you can record as is and decode during playback. The following explanation uses channels 1 and 2. If the mid-side mics are connected to channels 3 and 4, however, use the same procedures but substitute channels 3 for 1 and 4 for 2.

Decoding the input sound as you record

1. Connect MS mics to the **1/L** connector and **2/R** connector. Connect the mid mic to the **1/L** connector and the side mic to the **2/R** connector. Decoding cannot be conducted properly if the mid and side mics are connected in reverse.
2. On the REC MODE screen, set the REC MODE to STEREO, DUAL ST or 4CH, and set the SOURCE to CH1/2.

NOTE

If 4CH is selected on the REC MODE screen, the SOURCE item will not be shown and does not need to be set.

3. Set MS MODE to REC.
If 4CH is selected on the REC MODE screen, set MS MODE 1/2 to REC.

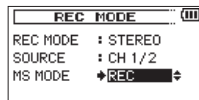

- Start recording to record a decoded MS signal.

NOTE

You can also set the MS MODE to REC on the MIXER screen.

Decoding the playback sound

- Select a file that was recorded by MS mics with MS MODE set to OFF.
- When the Home Screen is open, press the **MIXER** button to open the MIXER screen.
- Set MS MODE to MON.

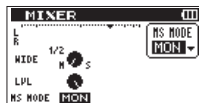

- Start playback to decode during playback.

MS decoder settings

When the MS MODE on the MIXER screen is set to REC or MON, the PAN item changes to WIDE, which allows you to adjust the stereo width of the sound.

To decode while recording, open the MIXER screen during recording standby.

To decode the signal during input, set MS MODE to REC. To decode the signal during playback, set MS MODE to MON.



Item	Setting range	Operation details
WIDE	0–100	Adjusts the width of the sound

At 0, mid is 100%. As the number increases, the amount of side signal increases.

9 – Connecting with a computer

By connecting this unit with a computer using the USB cable, you can transfer audio files on the SD card in the unit to a computer, as well as transfer audio files on the computer to the SD card in the unit.

WAV: 44.1/48/96kHz, 16/24-bit

BWF: 44.1/48/96kHz, 16/24-bit

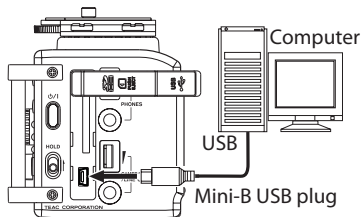

NOTE

- Instead of using USB to connect the DR-60DMKII and a computer, you can also conduct the same operations by removing the SD card from the DR-60DMKII and connecting it directly to a computer that has a built-in SD card slot or by using a card reader.
- The file extension used for both WAV and BWF file formats is “.wav”.

CAUTION

- When connected by USB and set to STORAGE, the other functions of the recorder are disabled.
- The unit should be connected directly with the computer instead of via a USB hub.

When the unit is connected through USB after being turned on, or when the unit is turned on after being connecting through USB, the USB SELECT screen appears to choose between bus power supply or data transmission through USB.



Turn the **DATA** dial to select STORAGE, and press the **DATA** dial to connect the unit with the computer for data transmission. The message of USB connected appears in the display.



Make sure that the SD card is inserted properly.

NOTE

If the USB cable is connected to the unit when batteries has been installed, the power is supplied from the USB port (USB bus power prioritized).

If an SD card is not properly inserted before making the USB connection, Can't Save Data appears on the screen.

This unit appears on the computer screen as external volume named “DR-60DMK2”.

9 – Connecting with a computer

Transferring files to a computer

1. Click the “DR-60DMK2” drive on the computer screen to show the “MUSIC” and “UTILITY” folders.
2. Open the “MUSIC” folder and drag and drop the files that you want to transfer to the computer to destinations of your choice.

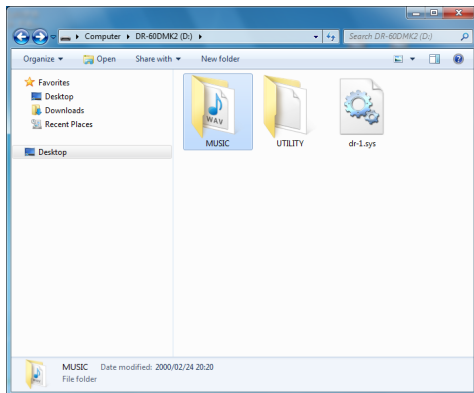

Transferring files from a computer

1. Click the “DR-60DMK2” drive on the computer screen to show the “MUSIC” and “UTILITY” folders.
2. Drag and drop files on the computer that you want to transfer to the unit to the “MUSIC” folder.

TIP

- You can manage the “MUSIC” folder from the computer.
- You can create subfolders in the “MUSIC” folder up to the second level for use with this unit. The DR-60DMKII cannot recognize subfolders and audio files on the third level or below.
- Since you can set the DR-60DMKII to only play the contents of a specific folder, you can organize files into genres, artists or other categories as you like.
- If you name the subfolders and music files, these names will appear on the Home screen or BROWSE screen of this unit.

Disconnecting from a computer

Before disconnecting the USB cable, use the proper procedures for your computer to unmount the DR-60DMKII (as an external drive). The power turns off (standby) after disconnecting the USB cable. See the computer’s operation manual for instructions about how to unmount an external drive.

10 – Settings and Information

Viewing Information (INFORMATION)

Use the INFORMATION Screen to view various types of information about your DR-60DMKII.

1. Press the **MENU** button to open the MENU screen.
2. Turn the **DATA** dial to select **OTHERS**, and press the **DATA** dial or **▶▶** button to open the OTHERS screen.
3. Turn the **DATA** dial to select **INFORMATION**, and press the **DATA** dial or **▶▶** button to open the FILE (1/3) page of the INFORMATION screen.

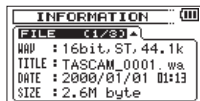

The INFORMATION screen contains the following three pages.

4. Turn the **DATA** dial to change the open page. The pages show the following information.

FILE (1/3)

Shows information about the currently loaded file.

CARD (2/3)

Shows the use status of the currently inserted SD card.

SYSTEM (3/3)

Shows the unit's system setting information and firmware version.

NOTE

If the currently loaded audio file is one of a pair of files created with dual recording or four-channel recording, there will be two FILE pages.

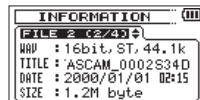
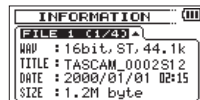

File information page

The FILE (1/3) page shows information about the currently selected file.

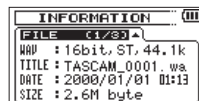

WAV/BWF

This shows the audio file format.

For both WAV and BWF files, bit length, stereo/mono and sampling frequency (Hz) are shown.

TITLE

This shows the file name.

DATE

Date of file creation

SIZE

File size

Card information page

The **CARD** (2/3) page shows the status of the currently inserted SD card.

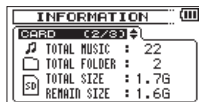

TOTAL MUSIC

Shows the number of playable files contained by the Music Folder.

TOTAL FOLDER

Shows the total number of folders in the Music Folder.

TOTAL SIZE

Shows the total SD card capacity.

REMAIN SIZE/USED SIZE

Shows the amount of unused/used capacity on the SD card.

Press the **◀◀** or **▶▶** button to switch between **REMAIN SIZE** and **USED SIZE**.

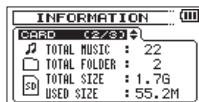

System information page

The **SYSTEM** (3/3) page shows information about the DR-60DMKII's system settings and firmware version.



AUTO PWR SAVE

This shows the time set for the automatic power saving function.

BACKLIGHT

Shows the automatic backlight OFF setting.

BATTERY

Shows the battery type options.

System Ver.

Shows the system firmware version.

10 – Settings and Information

System Settings and Formatting (SYSTEM)

From the SYSTEM Screen, you can change various settings to optimize the device for your use environment and other requirements. You can also initialize the unit and format the SD card.

1. Press the **MENU** button to open the MENU screen.
2. Turn the **DATA** dial to select OTHERS, and press the **DATA** dial or ►► button to open the OTHERS screen.
3. Turn the **DATA** dial to select SYSTEM, and press the **DATA** dial or ►► button to open the SYSTEM screen.

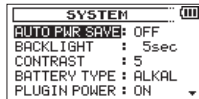

The following settings can be made for the items on the SYSTEM screen.

Use the ◀◀ or ►► button and the **DATA** dial to set each item.

Setting the automatic power saving function

Use the AUTO PWR SAVE item to set the amount of time without activity or operation until the unit turns off (enters standby) automatically.

Options: OFF (automatic power saving is disabled), 3min, 5min, 10min, 30min (default value)

Setting the backlight

Use BACKLIGHT to set the time until the backlight automatically turns OFF after the last operation when powered by the internal battery.

Options: OFF (turned off), 5sec (factory setting), 10sec, 15sec, 30sec, ALWAYS (always on)

Adjusting the display contrast

Use CONTRAST to adjust the display contrast.

Options: 1–20 (factory setting: 5)

Setting the type of AA batteries

Use BATTERY TYPE to set the type of the AA batteries that you are using. This setting is used to show the amount of remaining battery charge and determine if the unit has enough power for normal operation.

Values: ALKAL (alkaline batteries, default), Ni-MH (nickel-metal hydride batteries)

Setting the phantom power voltage

Use the PHANTOM VOLT item to set the voltage of the phantom power supplied when external mics that require it are connected.

Options: +24V, +48V (factory setting)

NOTE

Battery power will be consumed faster when set to +48V than when set to +24V.

Restoring the factory settings

Use the INITIALIZE item to restore the various settings of this unit to their factory settings.

1. Turn the **DATA** dial to select INITIALIZE, and press the **DATA** dial or ►| button to highlight Exec.
2. Press the **DATA** dial again to open a confirmation pop-up window.

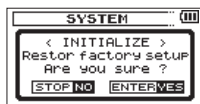

3. Press the **DATA** dial to initialize the unit. Press **Stop** (■) [HOME] button to cancel initialization.

Using QUICK FORMAT

Using QUICK FORMAT erases all music files on the card and automatically creates new "MUSIC" and "UTILITY" folders as well as the "dr-1.sys" file that is necessary to use the SD card with the DR-60DMKII.

1. Turn the **DATA** dial to select QUICK FORMAT, and press the **DATA** dial or ►| button to highlight Exec.
2. Press the **DATA** dial to open a pop-up confirmation window.

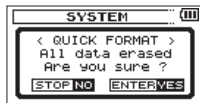

3. Press the **DATA** dial to execute the quick formatting, or press the **Stop** (■) [HOME] button to cancel formatting.

Using FULL FORMAT

Use the FULL FORMAT item to completely format the SD card. Full formatting checks the memory for errors while formatting, so it takes more time than quick formatting. Using FULL FORMAT erases all music files on the card and automatically creates new "MUSIC" and "UTILITY" folders as well as the "dr-1.sys" file that is necessary to use the SD card with the DR-60DMKII.

1. Turn the **DATA** dial to select FULL FORMAT, and press the **DATA** dial or ►| button to highlight Exec.
2. Press the **DATA** dial to open a pop-up confirmation window.

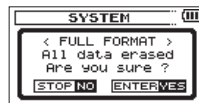

3. Press the **DATA** dial to execute the full formatting, or press the **Stop** (■) [HOME] button to cancel formatting.

CAUTION

When formatting a card, the unit should be operating on AC power supplied through the PS-P515U adapter (sold separately), USB bus power supplied from a computer, or batteries with sufficient remaining power. If the power fails during formatting, the formatting may not occur correctly.

10 – Settings and Information

Setting the format of file names

You can select the format of names given to files recorded by this unit.

1. Press the **MENU** button to open the MENU screen.
2. Turn the **DATA** dial to select **OTHERS**, and press the **DATA** dial or **▶▶** button to open the **OTHERS** screen.
3. Turn the **DATA** dial to select **FILE NAME**, and press the **DATA** dial or **▶▶** button to open the **FILE NAME** screen.



Use the **◀◀** or **▶▶** button and turn the **DATA** dial to set each item.

On this screen you can make the following settings for each item.

File name format

The **TYPE** item can be set to either **WORD** (default setting) or **DATE**.

WORD:

When set to **WORD**, a 6-character file name is used as the beginning of each file name.

Example: TASCAM_0001S12.wav

DATE:

The date is used as the file name (in yymmdd format).

Example: 110101_0000.wav

NOTE

The date is set using the unit's internal clock. (See "Setting the date and time" on page 37.)

Setting the WORD item

To set the **WORD** item, use the **◀◀** and **▶▶** buttons to move the cursor, and turn the **DATA** dial to select the character.

In addition to the alphabet and numbers, the following characters can be used:

! # \$ % & ' () + , - . : ; = @ [] ^ _ ` { } ~

Resetting the number (COUNT)

Select **COUNT INIT**, and press the **DATA** dial to execute it. The next file created after this will have the number "0001" after the characters set using the **WORD** item.

11 – Using the REMOTE jack

This unit has a **REMOTE** jack to which you can connect a TASCAM RC-3F footswitch-type remote control or TASCAM RC-10 wired remote control (both sold separately) that can be used to operate the unit.

Footswitch (TASCAM RC-3F)

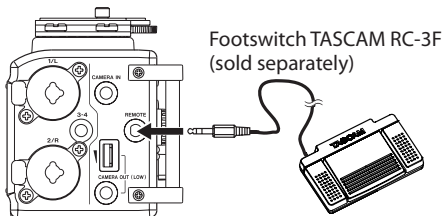

Setting footswitch operation

Use the REMOTE setting screen to make footswitch settings.

1. Press the **MENU** button to open the MENU screen.
2. Turn the **DATA** dial to select **OTHERS**, and press the **DATA** dial or **▶▶** button to open the **OTHERS** screen.
3. Turn the **DATA** dial to select **REMOTE**, and press the **DATA** dial or **▶▶** button to open the **REMOTE** screen.

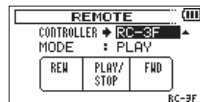
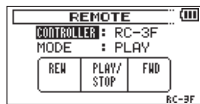

4. Turn the **DATA** dial to select **CONTROLLER**, and press the **DATA** dial or **▶▶** button.
5. Turn the **DATA** dial to select **RC-3F**. (default value: RC-3F)

6. Use the **◀◀** button or **DATA** dial to select **MODE**, and press the **DATA** dial or **▶▶** button.
7. Turn the **DATA** dial to set the switching mode for the footswitch.
Options: **PLAY** (default value), **RECORD1**, **RECORD2**, **RECORD3**, **REVIEW**

MODE	FOOT SW		
	L	C	R
PLAY	REW	PLAY/STOP	FWD
RECORD1	STOP	REC/PAUSE	INC
RECORD2	STOP	REC/PAUSE	MARK
RECORD3	STOP	REC/PAUSE	SLATE
REVIEW	FLASH	PLAY/STOP (Play while pressed)	FWD

INC: Track incrementing function

MARK: Mark function

FLASH: Jump-back playback

(All other functions are the same as using the buttons on the unit.)

8. When finished making the setting, press the **Stop** (■) [**HOME**] button to return to the Home Screen.

11 – Using the REMOTE jack

Using the footswitch

Press a pedal on the footswitch to operate the unit. The function of each pedal corresponds to the assignment shown on the REMOTE screen.

Remote control (TASCAM RC-10)

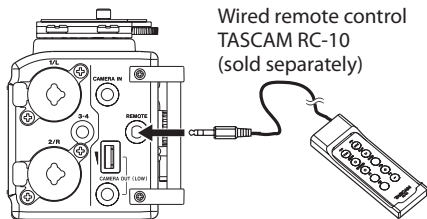

Setting the wired remote control

Make wired remote control settings on the REMOTE screen.

1. Press the **MENU** button to open the MENU screen.
2. Turn the **DATA** dial to select **OTHERS**, and press the **DATA** dial or **▶▶** button to open the OTHERS screen.
3. Turn the **DATA** dial to select **REMOTE**, and press the **DATA** dial or **▶▶** button to open the REMOTE screen.
4. Turn the **DATA** dial to select **CONTROLLER**, and press the **DATA** dial or **▶▶** button.

5. Turn the **DATA** dial to set **CONTROLLER** to **RC-10** (default value: **RC-3F**).

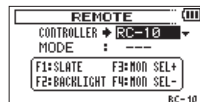

6. When finished making the setting, press the **Stop** (■) [**HOME**] button to return to the Home Screen.

Using the wired remote control

Press the function buttons (**F1 - F4**) on the wired remote control to use the function assigned on the REMOTE screen.

Overview of mode functions

MODES	Function buttons			
	F1	F2	F3	F4
---	SLATE	Backlight Always ON/ Backlight OFF	MonitorSelect +	MonitorSelect -

12 – Messages

The following is a list of the popup messages that might appear on the DR-60DMKII under certain conditions. Refer to this list if one of these popup messages appears and you want to check the meaning or determine a proper response.

Message	Meaning and response
File Name ERR	The DIVIDE function would cause the file name to exceed 200 characters. The DIVIDE function adds "a" or "b" to the end of the original file name. Before choosing the DIVIDE function, connect the unit to a computer and edit the file name to less than 198 characters.
Dup File Name	The DIVIDE function would cause the file name to be the same as that of an existing file. The DIVIDE function adds "a" or "b" to the end of the original file name. Before choosing the DIVIDE function, connect the unit to a computer and edit the file name.
File Not Found	The file either cannot be found or could be damaged. Check the file using a computer.
Non-Supported	The audio file is not a supported format. Please see "9 – Connecting with a computer" for file formats that this unit can use.
Battery Empty	The battery is almost out of power. Replace the AA batteries.
MBR Error Init CARD	The SD card is not formatted properly or the formatting is broken. Change the SD card or press the DATA dial when this message appears to format the SD card in FAT format. <u>CAUTION: Execution of FAT formatting erases all data currently on the SD card.</u>
Format Error Format CARD	The FAT formatting of the SD card is abnormal or broken. This message also appears if you FAT formatted the SD card using a computer connected by USB and if a new SD card is inserted in the unit. Always use the DR-60DMKII to conduct FAT formatting of SD card to be used with it. Change the SD card or press the DATA dial when this message appears to format the SD card in FAT format. <u>CAUTION: Execution of FAT formatting erases all data currently on the SD card.</u>
File Not Found Make Sys File	The system file is missing. This unit requires a system file for operation. When this message appears, press the DATA dial to automatically create a system file.
Invalid SysFile Make Sys File	The system file required to operate this unit is invalid. When this message appears, press the DATA dial to automatically create a system file.
Invalid Card Change Card	Something might be wrong with the SD card. Change the SD card.

12 – Messages

Message	Meaning and response
Write Timeout	Writing to the SD card timed out. Backup files on the SD card to your computer, and format the SD card.
Card Full	The SD card has no remaining capacity. Erase unnecessary files or move them to your computer to make open space.
Layer too Deep	Folders can be created down to two layers. You cannot create a new folder inside the current folder.
Can't Divide	The position selected for divide is not suitable (too close to the beginning or end of a file).
Max File Size	The file is larger than the designated size.
File Full	The total number of folders and files exceeds 5000. Erase unnecessary files or move them to your computer.
Card Error	The SD card could not be handled properly. Replace the SD card.
File Protected	The file is read only and cannot be erased.
No Card	No SD card is in the unit. Install a recordable SD card.
No PB File	There is no file that can be played back. The file might be damaged.
No Audio File	DIVIDE cannot be executed because there is no audio file.
Switched To Internal Battery	The power supply has switched from USB bus power to the batteries inside the unit.

Message	Meaning and response
Not Continued	<p>If any of these errors occurs, turn the unit's power off and restart it. If the power cannot be turned off, remove the batteries, disconnect the TASCAM PS-P515U AC adaptor (sold separately), and/or disconnect the USB cable for bus power supply. If the error message continues to appear frequently, please contact a TASCAM Customer Support (see the back cover for details).</p>
File Error	
Can't Save Data	
Player Error	
Device Error	
Writing Failed	
Sys Rom Err	
Remote Cmd	
Remote Rx	
System Err 50	
System Error 1	
System Error 2	
System Error 3	
System Error 4	
System Error 5	
System Error 6	
System Error 7	
System Error 8	
System Error 9	

13 – Troubleshooting

If you are having trouble with the operation of this unit, please try the following before seeking repair. If these measures do not solve the problem, please contact the store where you bought the unit, an authorized distributor or a TASCAM Customer Support (see the back cover for details).

■ Power will not turn ON.

- Confirm that the batteries are not dead.
- Confirm that the batteries are installed with the correct ⊕/⊖ orientation.
- Confirm that the TASCAM PS-P515U AC adaptor (sold separately) is firmly connected to both the socket and the unit.
- Confirm that the USB cable (if used for USB bus power supply) is firmly connected.
- Confirm that the USB cable (if used for USB bus power supply) is not connected via a USB hub.
- Confirm that the **HOLD** switch is not set in the direction of the arrow.

■ The unit turns off automatically

- Is the automatic power saving function enabled? (See “Setting the automatic power saving function” on page 76.)
- This product is compliant with the European ErP standby power regulations. For this reason, the automatic power saving function will operate whether it is running on batteries or using the AC adaptor. Set the automatic power saving function setting to OFF if you want to disable it. (The factory default setting is 30 minutes.)

■ The unit does not function.

- Confirm that the **HOLD** switch is not set in the direction of the arrow.
- Is the unit connected to a PC with the USB cable? (Is USB connected shown on the display?)

■ The SD card is not recognized.

- Confirm that the SD card is inserted completely.

■ Playback does not work.

- Confirm that the sampling frequency of the WAV file is supported by this unit.

■ No sound is output.

- Is the monitoring system connected correctly?
- Is the volume of the monitoring system minimized?
- Is the OUTPUT LEVEL setting of the unit minimized?

■ Recording does not work.

- If you are using an external device, check the connection again.
- Check the input settings again.
- Confirm that the input level is not too low.
- Confirm that the SD card is not full.
- Confirm that the number of files has not reached the maximum that the unit can handle.

■ The input level is low.

- Confirm that the input level setting is not too low.
- Confirm that the output level of a connected external device is not too low.

■ The source I am trying to record sounds distorted.

- Is the input level set too high?

■ The playback sounds unnatural.

- Check the playback equalizer setting.
- Is the level align function active?

■ I cannot erase a file.

- Confirm that you are not trying to erase a file that has been copied from a computer after being write-protected.

■ This unit's files do not appear on the computer.

- Confirm that the unit is connected to the computer using its USB port.
- Confirm that USB hubs are not used.
- Confirm that the unit is not recording or in recording standby mode.

14 – Specifications

Ratings

Recording media

SD card (64MB – 2GB)

SDHC card (4GB – 32GB)

File system

WAV: 44.1/48/96 kHz, 16/24-bit

BWF (Broadcast Wave Format): 44.1/48/96 kHz, 16/24-bit

Number of channels

4 channels (stereo × 2)

Inputs and outputs

Analog audio input and output

1/L connector, 2/R connector (phantom power supported)

Connector: XLR-3-31 (1: GND, 2: HOT, 3: COLD)

6.3mm (1/4") standard TRS Jack

(Tip: HOT, Ring: COLD, Sleeve: GND)

Input switch set to **MIC** or **MIC+PHANTOM**

Input impedance: 2k Ω

Phantom power: 48V \pm 4V(10mA/CH) or 24V \pm 4V(10mA/CH)

Maximum input level: 0dBu

Minimum input level: -72dBu

Mic input gain (input level knob at maximum)

LOW: +11 dB

MID: +36 dB

HIGH: +52 dB

HI+PLUS: +64 dB

Input switch set to **LINE**

Input impedance: 10 k Ω or higher

Standard input level: +4 dBu

Maximum input level: +24 dBu

3-4 jack (supports plug-in power)

Connector: 3.5mm (1/8") stereo mini jack

Input impedance: 10 k Ω

Maximum input level: +10 dBV

Minimum input level: -50 dBV

Mic input gain (input level knob at maximum)

LOW: +3 dB

HIGH: +26 dB

HI+PLUS: +38 dB

CAMERA IN jack

Connector: 3.5mm (1/8") stereo mini jack

Input impedance: 10 k Ω

Standard input level: -10 dBV

Maximum input level: +6 dBV

CAMERA OUT (LOW) jack

Connector: 3.5mm (1/8") stereo mini jack

Output impedance: 200 Ω

Standard output level: –50 dBV
Maximum output level: –30 dBV

PHONES jack

Connector: 3.5mm (1/8") stereo mini jack
Maximum output: 50 mW + 50 mW

CAMERA OUT (HIGH)/LINE OUT jack

Connector: 3.5mm (1/8") stereo mini jack
Output impedance: 200 Ω
Standard output level: –10 dBV
Maximum output level: +10 dBV

Note)

Maximum input level: level at which a digital full-scale (0 dBFS) signal can be input without distorting when you adjust the input knob

Minimum input level: level at which a standard level (–20 dBFS) signal can be input when you adjust the input knob

Control input and output

USB jack

Connector: USB Mini-B Type
Format: USB 2.0 HIGH SPEED mass storage class

REMOTE jack

Connector: 2.5mm TRS Jack

Audio performance

Frequency response

20-20kHz +0.5/–2dB

(LINE IN or MIC IN to LINE OUT, Fs44.1k/48kHz, JEITA)

20-40kHz +0.5/–3dB (LINE IN or MIC IN to LINE OUT, Fs96kHz, JEITA)

Distortion

0.02% or less

(LINE IN or MIC IN to LINE OUT, Fs44.1k/48k/96kHz, JEITA)

S/N ratio

92dB or more

(LINE IN or MIC IN to LINE OUT, Fs44.1k/48k/96kHz, JEITA)

Equivalent input noise

–120dBu or more

Note) JEITA: Conforming to JEITA CP-2150

Computer compatibility

For the latest information on compatible operating systems, check the TEAC Global Site (<http://teac-global.com/>).

Windows

Pentium 300 MHz or faster

128 MB or more memory

USB port (USB 2.0 recommended)

Macintosh

14 – Specifications

Power PC, iMac, G3, G4 266MHz or faster
64 MB or more memory
USB port (USB 2.0 recommended)

Recommended USB host controller

Intel chipset

Supported operating systems

Windows: Windows XP, Windows Vista, Windows 7 or Windows 8
(including 8.1)

Macintosh: Mac OS X 10.2 or later

Other specifications

Power

Four AA batteries (Alkaline or Ni-MH)
USB bus power supplied from a computer
AC adaptor (TASCAM PS-P515U, sold separately)
External battery pack designed for this unit (TASCAM BP-6AA, sold separately)

Power consumption

5.4W (maximum)

Battery operation time (continuous operation)

When using Alkaline batteries (EVOLTA)

Format	Continuous operating time (hours: minutes)	Note
Recording 2-channel 44.1kHz/16-bit WAV files	About 2:30	MIC + PHANTOM (48V) input selected
Recording 2-channel 44.1kHz/16-bit WAV files	About 4:30	MIC input selected (phantom power not used)

When using Ni-MH batteries (eneloop)

Format	Continuous operating time (hours: minutes)	Note
Recording 2-channel 44.1kHz/16-bit WAV files	About 3:15	MIC + PHANTOM (48V) input selected
Recording 2-channel 44.1kHz/16-bit WAV files	About 5:00	MIC input selected (phantom power not used)

When using Ni-MH batteries (eneloop pro)

Format	Continuous operating time (hours: minutes)	Note
Recording 2-channel 44.1kHz/16-bit WAV files	About 3:45	MIC + PHANTOM (48V) input selected
Recording 2-channel 44.1kHz/16-bit WAV files	About 6:00	MIC input selected (phantom power not used)

14 – Specifications

Continuous operating time when using batteries and a TASCAM BP-6AA (sold separately)

When using Alkaline batteries (EVOLTA) and BP-6AA (EVOLTA)

Format	Continuous operating time (hours: minutes)	Note
Recording 2-channel 44.1kHz/16-bit WAV files	About 5:30	MIC + PHANTOM (48V) input selected
Recording 2-channel 44.1kHz/16-bit WAV files	About 10:30	MIC input selected (phantom power not used)

When using NiMH batteries (eneloop) and BP-6AA (eneloop)

Format	Continuous operating time (hours: minutes)	Note
Recording 2-channel 44.1kHz/16-bit WAV files	About 7:30	MIC + PHANTOM (48V) input selected
Recording 2-channel 44.1kHz/16-bit WAV files	About 12:00	MIC input selected (phantom power not used)

When using NiMH batteries (eneloop pro) and BP-6AA (eneloop pro)

Format	Continuous operating time (hours: minutes)	Note
Recording 2-channel 44.1kHz/16-bit WAV files	About 9:30	MIC + PHANTOM (48V) input selected
Recording 2-channel 44.1kHz/16-bit WAV files	About 14:30	MIC input selected (phantom power not used)

NOTE

When using phantom power, the continuous operating time will become shorter depending on the microphone used.

Dimensions (W x H x D)

133 x 93.2 x 78mm / 5.24 x 3.67 x 3.07inches (with the top adapter attached)

Weight

510g / 18(oz) (not including batteries)

Operating temperature range

0 - 40°C (32°F - 104°F)

Dimensional drawings

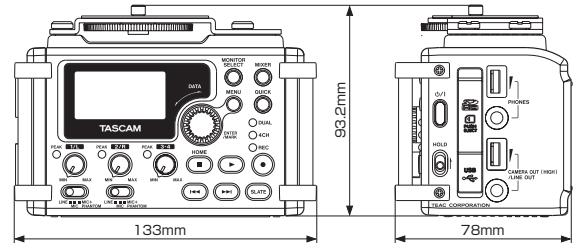

- Illustrations and other depictions may differ in part from the actual product.
- Specifications and external appearance may be changed without notification to improve the product.

TASCAM

DR-60DMK II

TEAC CORPORATION

Phone: +81-42-356-9143
1-47 Ochiai, Tama-shi, Tokyo 206-8530 Japan

<http://tascam.jp/>

TEAC AMERICA, INC.

Phone: +1-323-726-0303
1834 Gage Road, Montebello, California 90640 USA

<http://tascam.com/>

TEAC MEXICO, S.A. de C.V.

Phone: +52-55-5010-6000
Río Churubusco 364, Colonia Del Carmen, Delegación Coyoacán, CP 04100, México DF, México

<http://teacmexico.net/>

TEAC UK LIMITED

Phone: +44-8451-302511
Meridien House, Ground Floor, 69 - 71, Clarendon Road, Watford, Hertfordshire, WD17 1DS, UK

<http://tascam.eu/>

TEAC EUROPE GmbH

Phone: +49-611-71580
Bahnstrasse 12, 65205 Wiesbaden-Erbenheim, Germany

<http://tascam.eu/>

TEAC SALES & TRADING(SHENZHEN) CO., LTD

Phone: +86-755-88311561~2
Room 817, Block A, Hailun Complex, 6021 Shennan Blvd., Futian District, Shenzhen 518040, China

<http://tascam.cn/>

Printed in China