



ANGRY AUDIO

PHONE

+1 (615) 763-3033

WEB

answers@angryaudio.com
www.angryaudio.com

ADDRESS

128 HOLIDAY CT STE 118
Franklin TN 37067 USA

USER GUIDE



Mic Tally Gizmo

P/N 991025

Revision 1.1 - 08/20

Welcome to the world of Angry Audio, home of the audio gadgets.

The audio world is filled with complex, high-tech gear. Much of it bristles with seductive shapes and eye-catching lights and displays, and all of it promises to make things sound better and open up new creative possibilities.

But in order for those products to shine, you still have to get the basics right and sweat the details. Good audio isn't made by one component. It's made by getting things right every step of the way, especially the little things. The same is true for good content, and while we're not in the business of delighting your listeners with our mad accordion skills (though we could be should demand pick up) we do understand that a thoughtful, well-designed studio removes barriers and becomes transparent to your talent and their guests, and allows them to ply their craft to the best of their abilities.

Accordingly, every audio gadget and gizmo – including the Mic Tally Gizmo – is designed to solve common yet critical problems, and is meticulously engineered with performance and longevity in mind to deliver pristine audio and reliable performance for many years.

Our promise and guarantee.

We're confident you'll love your Mic Tally Gizmo, but who knows, you just might be one of the 0.00001% who don't. That's why we give you and your Gizmo 30 days to hang out and bond. If you have irreconcilable differences, we'll buy it back.

Plus, every Gadget and Gizmo is warranted to be free from defects in parts and workmanship for two full years after you purchase it. If it fails within this time period, Angry Audio, at its discretion, will repair or replace it so long as you let us know of the failure within the warranty period and can provide proof of purchase in the form of a dated sales receipt. You can call us at +1 615-763-3033, or reach us online at www.angryaudio.com/contact.

Making a good first impression.

When you unbox your Mic Tally Gizmo, we hope it makes a good first impression and you take a moment to appreciate the lengths we've gone to in order to create a "built for broadcast" product. All of our products are over-engineered to provide long-term reliability and guaranteed RFI immunity. Some of this is apparent – such as the durable powder-coated steel enclosure - but much of this goodness is invisible, like the premium components within. Even if you can't see it, you'll hear it!

A word or two about safety.

Most of this falls under the category of common sense, but we've all seen facilities that would cause a safety inspector to wake up at night in a cold sweat and reconsider his or her career choice. If you're not convinced your fellow humans aren't capable of some incredibly creative lapses in judgement on the safety front, the interwebs is chock full of videos of people trying their best to win a Darwin award.

The Mic Tally Gizmo isn't a wood chipper or a table saw with a missing blade guard and its "Stop" switch bypassed. Installing one in your studio doesn't carry with it the risk of, say, hanging a fully populated beehive under the console. But still, it is intended to be installed and used by qualified personnel only. To avoid electric shock, do not open the unit or attempt to perform any servicing unless you are qualified to do so.

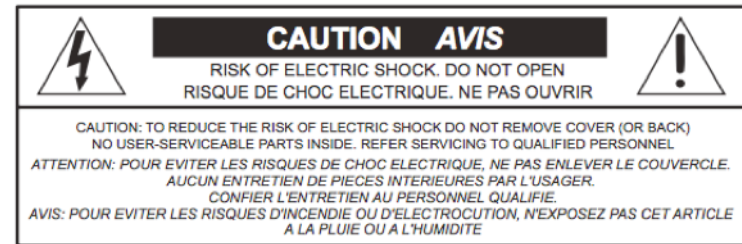

The Mic Tally Gizmo has an external power supply. Hazardous voltages are present within the supply and at the input of the Gizmo itself. Voltage may still be present on certain components even when the unit is unplugged.

The power supply cord is the primary disconnect device and so the outlet providing power to the gadget should be easily accessible. In other words, make sure you can back out of making any bad electrical decisions by easily pulling the plug. Do not overload outlets.

Do not expose your Gizmo or its power supply to rain or moisture. Any electronic device can fail without warning; do not use this product in applications where a life threatening condition could result due to failure.

Some customers have inquired as to whether or not doing The Safety Dance actually works to enhance workplace safety. We have no proof to support this claim, but watching the video on YouTube provides nearly three minutes of hard evidence that the 80's was one weird decade.

What is this magical device?

Glad you asked. See those spiffy new M!KA microphone arms you bought for your studio? The ones with the tally light? Ooooooh – pretty. But short of placing them within a few feet of an AM phasor cabinet or that ancient Amana Radar Range in the break room with the leaky door seal, lighting them up requires some effort on your part.

Enter the Mic Tally Gizmo.

How does it work?

The Mic Tally Gizmo has a 5-pin XLR connector on its top side that carries both microphone audio and the necessary signal voltage to power the tally light. Underneath, a standard 3-pin XLR connector carries audio to your mic pre-amp, mic processor, or console.



Meanwhile, dual logic inputs drive the tally to light up either red or white. Red is typically used to indicate the mic is on-air, while white can be used for whatever you like – ready light, talkback indicator, ringing phone, pizza delivery, GM's car approaching – we'll leave that up to you.

The Mic Tally Gizmo is simple to install in your existing studio furniture with minimal tools and an equally minimal set of carpentry skills. If you can use a hole saw without doing yourself an injury, you can install your Gizmo and look like a woodworking rock star.

Installing your Mic Tally Gizmo.

The Mic Tally Gizmo is designed to be installed directly into your studio furniture in a location that is practical and convenient. The only tools required are a power drill and a 2 1/8 inch hole saw to create the grommet hole; a router is not required. The Gizmo is then secured with four screws. Spacing and dimensions are shown along with a handy to-scale template suitable for printing on Page 4. Two anchor holes are provided on the back of the Gizmo to secure the supplied tie wraps. We recommend bundling the power and logic cables on one side and securing the audio cables to the other.

One handy-dandy printable template.

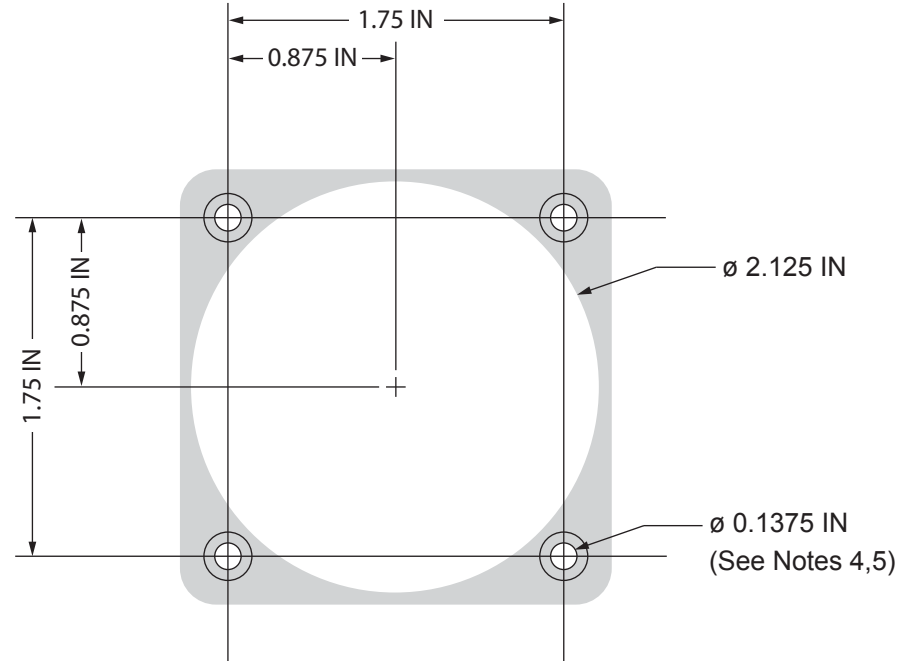

1. This template can be used as a guide for locating holes. Your printer must be set to print this page at 100% actual size. If your printer shrinks images to fit the page, the dimensions will be wrong. Measure the printed page with a ruler to make sure the printed dimensions match the actual size.
2. Once you've decided where you want your Mic Tally Gizmo, tape the template to your desktop. Remember to leave at least 12 inches between the edge of the desk facing the user and the Gizmo. Use an awl or center punch at all five hole centers and remove the template.
3. Drill the 2.125 inch diameter center hole. This hole must go completely through the table.
4. For hardwood, plywood or MDF desktops, drill a 1/16 inch pilot hole for each corner hole. Use the four thoughtfully included flathead wood screws to secure the Gizmo. Do not over-tighten.
5. For desktops constructed of other materials including stone or glass or those of a hollow (honeycomb) construction, the corner holes must be 0.1375 inch diameter through holes to allow a flathead bolt (not thoughtfully provided) to pass through the desktop and secured with a nut (also not provided) from beneath.

Front controls and connections.

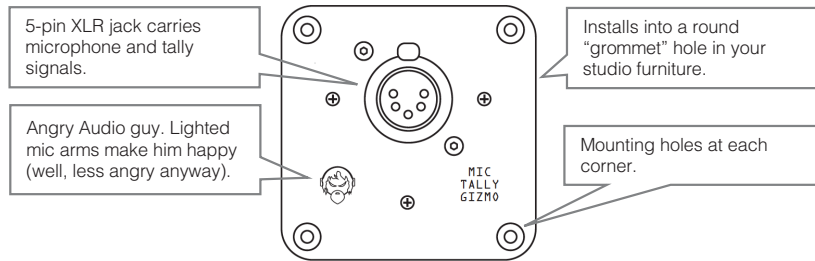

Rear connections.

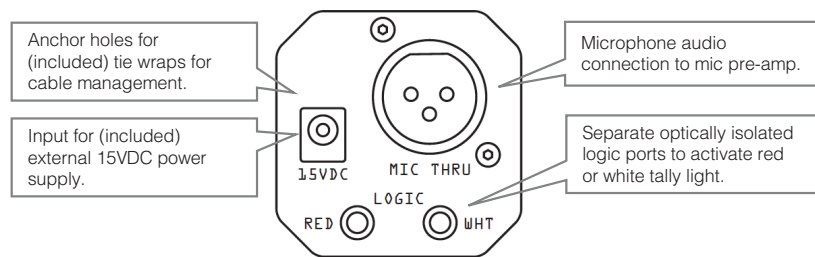

Wiring the XLR connections.

Your MIKA arm is equipped with a captive cable. The end that exits near the base of the arm carries the microphone signal and tally light voltage. You will need to attach a 5-pin XLR male connector (such as the Neutrik NC5MX) to the end of this cable. Take care not to cut this cable too short, and leave sufficient slack for the mic arm to move freely and for the plug to be installed and removed for service.

Please pay careful attention to the drawing and chart below for correct pin assignments as incorrect wiring may damage the Gizmo and/or the microphone.

- Pin 1 – Microphone shield – Shield
- Pin 2 – Microphone hot – Red
- Pin 3 – Microphone cold – Black
- Pin 4 – Tally hot – Orange
- Pin 5 – Tally cold - Black

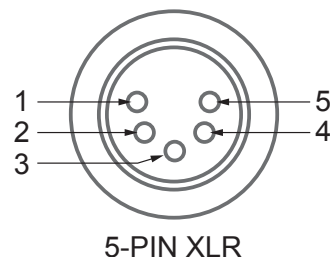

Logic connections.

The logic ports on the Mic Tally Gizmo are 3.5mm (1/8 inch) mini TRRS (tip – ring – ring – sleeve) jacks. You will need 3.5mm mini TRRS plugs for the logic wiring. If the thought soldering connections on these tiny little plugs brings back bad childhood memories of playing “Operation”, convenient screw terminal adapter plugs are available on line. Do a Google or Amazon search for “Poyiccot 3.5mm 4 Pole Stereo TRRS Male Jack to AV 4 Screw Terminal Block Connector” for an example of one we particularly like.

The ports are designed to accommodate a variety of different logic types as follows:

Your console provides a voltage tally: This is common for radio consoles with illuminating button panels. In this case, you will connect the positive source to Ring 1 and the negative return to Ring 2. No connections will be made to the Tip or Sleeve. The Mic Tally Gizmo can accommodate voltages between 5 and 24VDC.

Your console provides dry relay contacts: This is not as common but not unheard of. In this case, the Mic Tally Gizmo provides its own voltage source. Connect the Tip to Ring 1. Connect Ring 2 to your relay NO (normally open) contact. Connect the Sleeve to your relay C (common) contact.

Your console provides an open collector and its own positive voltage source: Connect Ring 1 to the voltage source. Connect Ring 2 to the open collector. Do not connect anything to the Tip or Sleeve.

Your console provides an open collector or open drain but does not provide its own voltage source: Connect the Tip to Ring 1. Connect Ring 2 to your open collector. Connect the Sleeve to your console logic common.

You do not have a console but wish to use a switch to activate the logic: Connect the Tip and Ring 1. Connect Ring 2 to one of your switch contacts. Connect the other switch contact to Sleeve.

The example cable below illustrates how to wire the Red logic input to an Axia GPIO port:

- Tip – Mic Tally Gizmo +12VDC
- Ring 1 – Optocoupler anode (+)
- Ring 2 – Optocoupler cathode (-)
- Sleeve – Mic Tall Gizmo ground

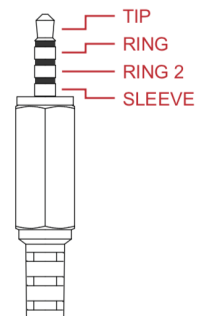

3.5MM TRRS CONNECTOR

Connecting the Electronics.

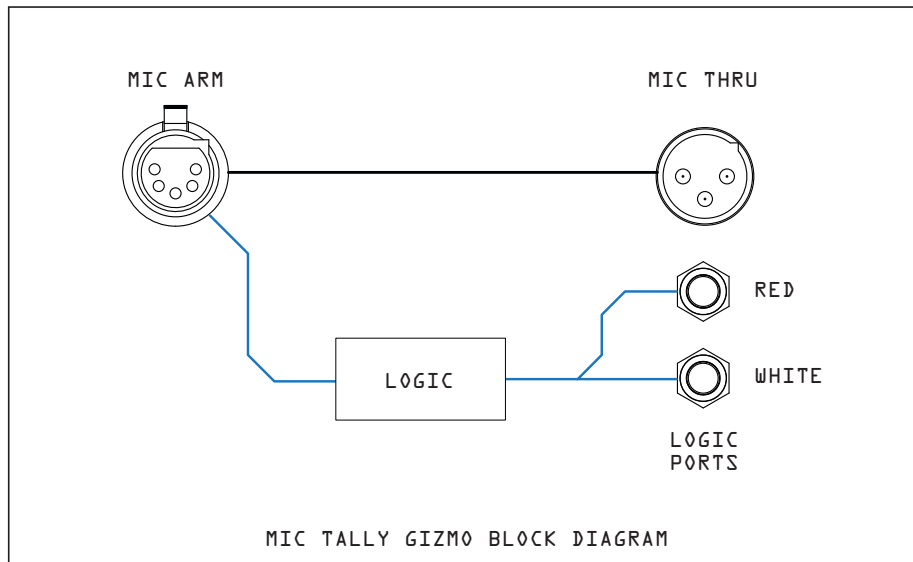

Compliance in the U.S.

In the U.S., this Gizmo complies with the limits for a Class A computer device as specified by FCC Rules, Part 15, Subpart J, which are designed to provide reasonable protection against such interference when this type of equipment is operated in a commercial environment.

...and in Canada.

In Canada, this Gizmo does not exceed the Class A limits for radio noise emissions set out in the Radio Interference Regulations of the Canadian Department of Communications.

...and in Europe.

This Gizmo complies with the requirements of the EEC Council Directives 93/68/EEC (CE Marking), 73/23/EEC (safety – low voltage directive), and 89/336/EEC (electromagnetic compatibility). Conformity is declared to standards EN50081-1 and EN50082-1.

Riveting data about your Gizmo.

Part Numbers

Mic Tally Gizmo	
Universal Power Supply	991025

Connections

Mic Arm Input	5-pin XLR female jack
Mic Thru	3-pin XLR male jack
Logic Ports	3.5mm TRSS jack
Power	15VDC input

Power and Environmental

Power Input (Adapter)	100-240VAC, 50-60Hz, various plugs
Power Output (Adapter)	15VDC, 200mA, 3.0W
Tally Output	12VDC, 80mA
Operating Temperature	0° to 40° C (32° to 104° F)
Storage Temperature	-20° to 45° C (-4° to 113° F)
Relative Humidity	0% to 90% non-condensing

Product Weight & Dimensions

Shipping box	9in x 5in x 5in, 4 pounds
--------------	---------------------------

Box Includes:

- Mic Tally Gizmo
- Power Adapter
- AC Blades: US, UK, AU, EU
- XLRF to RJ45 Adapter
- 3.5mm to screw terminal adapter (2x)

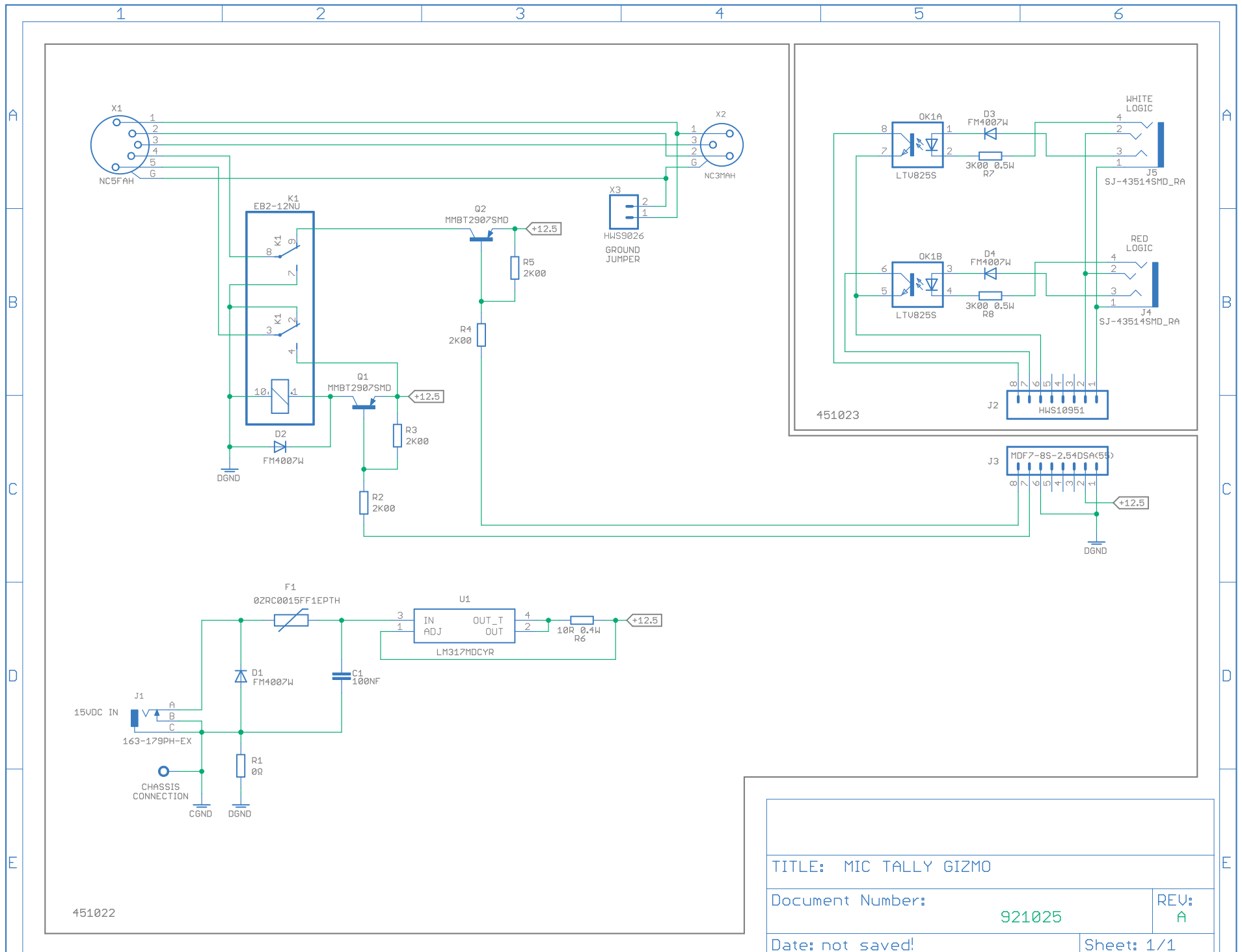

TITLE: MIC TALLY GIZMO	
Document Number:	921025
Date: not saved!	Sheet: 1/1

REV: A