



Glensound

AoIP22

**DANTE[®]/ AES67 NETWORK AUDIO
2 INPUT 2 OUTPUT LINE LEVEL ANALOGUE
INTERFACE**

PRODUCT DETAILS



GlenSound Electronics Ltd

Thank you for choosing a new GlenSound product.

All rights reserved.

Information contained in this manual is subject to change without notice, if in doubt please contact us for the latest product information.

If you need any help with the product then we can be contacted at:

GlenSound Electronics Ltd
1 – 6 Brooks Place
Maidstone
Kent
ME14 1HE
United Kingdom

Telephone: +44 (0) 1622 753662

Fax: +44 (0) 1622 762330

EMAIL ADDRESSES

General enquires: office@glenSound.co.uk

Technical enquires: techinfo@glenSound.co.uk

Sales enquires: sales@glenSound.co.uk

IMPORTANT SAFETY INSTRUCTIONS

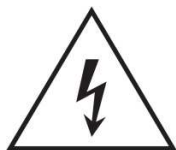

This symbol is intended to warn that dangerous voltages within the product are present and constitute a risk of electric shock.



This symbol is intended to highlight that there are important operating & maintenance instructions in the literature accompanying this unit.

- 1) Read these instructions
- 2) Keep these instructions
- 3) Heed all warnings
- 4) Follow all instructions
- 5) Do not use this apparatus near water
- 6) Clean only with a dry cloth
- 7) Do not block any ventilation openings. Install in accordance with manufacturer's instructions
- 8) Do not install near any heat sources such as radiators, heat registers, stoves, or other apparatus (including amplifiers) that produce heat
- 9) Do not defeat the safety purpose of the polarized or grounding type plug. A polarized plug has 2 blades with one wider than the other. A grounding type plug has 2 blades and third grounding prong. The wider blade or the 3rd prong are provided for your safety. If the provided plug does not fit into your outlet, consult an electrician for replacement of the obsolete outlet
- 10) Protect the power cord from being walked on or pinched, particularly at plugs, convenience receptacles and the point where they exit from the apparatus
- 11) Only use attachments/ accessories specified/ supplied by the manufacturer



- 12) Use only with the cart, stand, tripod, bracket, or table specified by the manufacturer, or sold with the apparatus. When a cart is used, use caution when moving the cart/ apparatus combination to avoid injury from tip over
- 13) Unplug this apparatus during lightning storms or when unused for long periods of time
- 14) Refer all servicing to qualified service personnel. Servicing is required when the apparatus has been damaged in any way, such as power supply cord or plug is damaged, liquid has been spilled or objects have fallen into the apparatus, the apparatus has been exposed to rain or moisture, does not operate normally, or has been dropped
- 15) Do not attempt to modify this product. Doing so could result in personal injury and/ or product failure

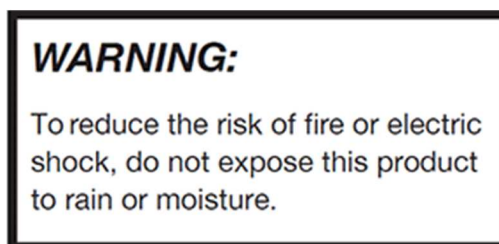
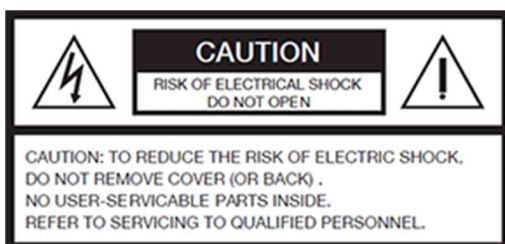

PRODUCT WARRANTY:

All equipment is fully tested before dispatch and carefully designed to provide you with trouble free use for many years.

We have a policy of supporting products for as long as possible and guarantee to be able to support your product for a minimum of 10 years.

For a period of one year after the goods have been despatched the Company will guarantee the goods against any defect developing after proper use providing such defects arise solely from faulty materials or workmanship and that the Customer shall return the goods to the Company's works or their local dealer.

All non-wear parts are guaranteed for 2 years after despatch and any defect developing after proper use from faulty materials or workmanship will be repaired under this warranty providing the Customer returns the goods to the Company's works or their local dealer.



SAFETY WARNING



The AIOP22 contains no user serviceable parts and **must not** be dissassembled in any way.



EU DECLARATION OF CONFORMITY FOR:

AOIP22

Two channel AoIP, Analogue I/O interface

This declaration of conformity is issued under the sole responsibility of the manufacturer.

This equipment is manufactured by GlenSound Electronics Ltd of Brooks Place Maidstone Kent ME14 1HE is  marked and conforms to the following Union harmonisation legislation:

Low Voltage Directive:	EN60065 and EN62368-1:2014
Emissions:	BS EN55032:2015
Immunity:	BS EN55035:2017

Signed for and on behalf of GlenSound Electronics Ltd.

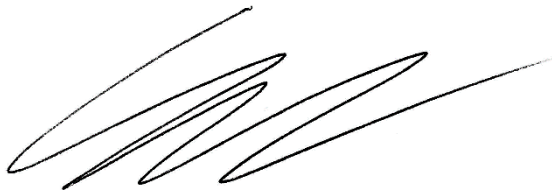

Gavin Davis, Managing Director
Maidstone, Kent, England

Date: 07/006/2018

RoHS DIRECTIVE

EC directive 2002/95/EC restricts the use of the hazardous substances listed below in electrical and electronic equipment.

This product conforms to the above directive and for this purposes, the maximum concentration values of the restricted substances by weight in homogenous materials are:

Lead	0.1%
Mercury	0.1%
Hexavalent Chromium	0.1%
Polybrominated Biphenyls	0.1%
Polybrominated Diphenyl Ethers	0.1%
Cadmium	0.01%

WASTE ELECTRICAL AND ELECTRONIC EQUIPMENT REGULATIONS 2006 (WEEE)

GlenSound Electronics Ltd is registered for business to business sales of WEEE in the UK our registration number is:

WEE/JJ0074UR

GLENSOUND AOIP22

Handbook Contents

Issue 1

Description

Page No.

Contents

IMPORTANT SAFETY INSTRUCTIONS.....	3
PRODUCT WARRANTY:.....	4
OVERVIEW	9
EXAMPLES OF USE.....	10
AOIP22 FRONT PANEL LAYOUT	12
AOIP22 RIGHT SIDE PANEL LAYOUT	13
AOIP22 LEFT SIDE PANEL LAYOUT.....	14
SIMPLIFIED BLOCK DIAGRAM	15
CONNECTING THE AoIP22 TO A DANTE NETWORK	16
Getting Dante Controller.....	16
Connecting AoIP22 To the Network.....	16
Audio Over IP Network.....	16
Running Dante Controller.....	17
Dante Controller TIP	17
AES67 MODE	18
UPDATING FIRMWARE.....	21
UPDATING THE ULTIMO CHIPSET.....	27
WIRING INFORMATION	28
1. Standard Pin Outs	28
2. Wiring to unbalanced devices.....	28
SPECIFICATION.....	29

OVERVIEW

The GlenSound AOIP22 is an analogue to digital and digital to analogue converter designed to connect line level analogue audio circuits to a Dante® audio network.

Dante® network audio is a common protocol for distributing high quality linear audio over standard IP networks and it is widely used by many audio equipment manufacturers. The AOIP22 Dante® audio interface is compatible with all Dante® audio interfaces across all manufacturers. Further details of Dante® network audio can be found at www.audinate.com

Intended for live on-air broadcast applications, the AOIP22 is built into a rugged lightweight aluminium chassis with anodised and laser etched panels. Holes suitable for temporarily attaching the unit with cable ties to hold it in place and a removable belt-clip are provided for ease of installation.

The AOIP22 provides 2 analogue line level (0dB) inputs to the Dante® network and 2 analogue line level (0dB) outputs from the Dante® network. These circuits are electronically balanced on XLRs but can be wired unbalanced.

AES67 is supported by the Audinate's Ultimo chipset and can be easily turned on/off via Dante® controller.

Sample frequencies from 44.1 to 96kHz are supported by the unit when connected to a Dante® network and 48kHz is supported when in AES67 mode.

As per our other Dante® equipment 0dBu = -18dBfs

EXAMPLES OF USE

Example 1

Interface To Existing Dante Network

Commentary Unit Connection To An Existing Dante Network

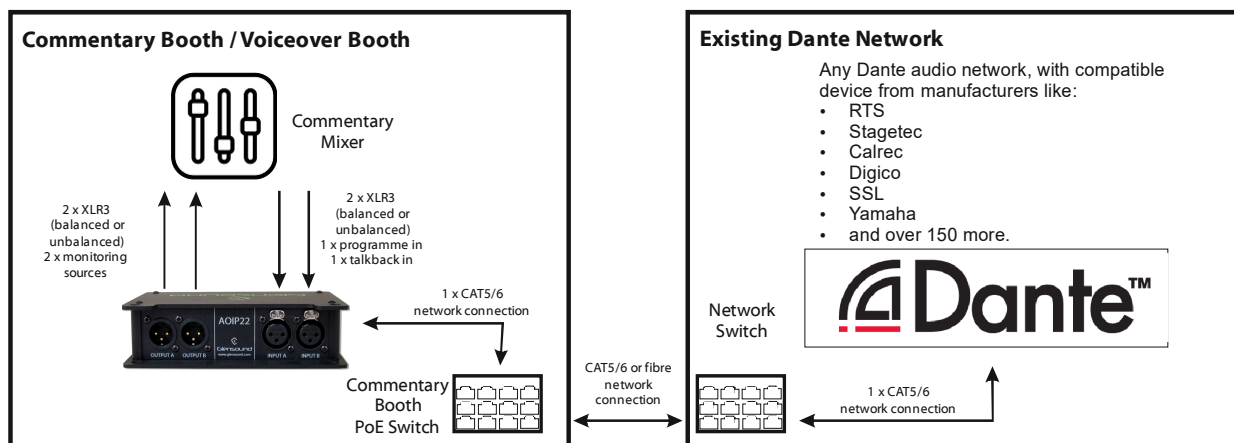

There are over 150 manufacturers that design Dante compatible equipment. In this example, the broadcaster has an established Dante® network. This is most likely to be an audio console, or an intercom system.

The broadcaster needs to expand the network by adding an existing commentary booth / voice over position. Using the AoIP22, the commentary position can be added to the existing Dante® network very cost effectively.

The AoIP22 is located in the commentary booth, and connected into the broadcast network via a single CAT5/6 cable.

The Glensound GS-CU008A is a popular and widely used commentary unit by broadcasters. It provides a programme output, and has a talkback outputs. These connect to the inputs of the AoIP22 via XLR connections.

The AoIP22 outputs connect to the headphone monitoring inputs on the GS-CU008A via XLR. This allows the commentator to hear 2 audio channels. These are typically the programme audio, and talkback return.

The audio routing can be configured via the Dante® Controller software. Simply run Dante® Controller on any PC connected to the network. All available sources and destinations will be shown on the AoIP22, and all other Dante® compatible devices on the network. Click the check boxes to route the audio in the desired directions, and the system is now ready to be used.

Audio routing only needs to be configured by Dante® Controller on the first time the AoIP22 is connected to the network as all routes are stored locally on the device.

Example 2

Interface To Existing Codec or TBU in Racks Room

Two channel audio interface to existing equipment

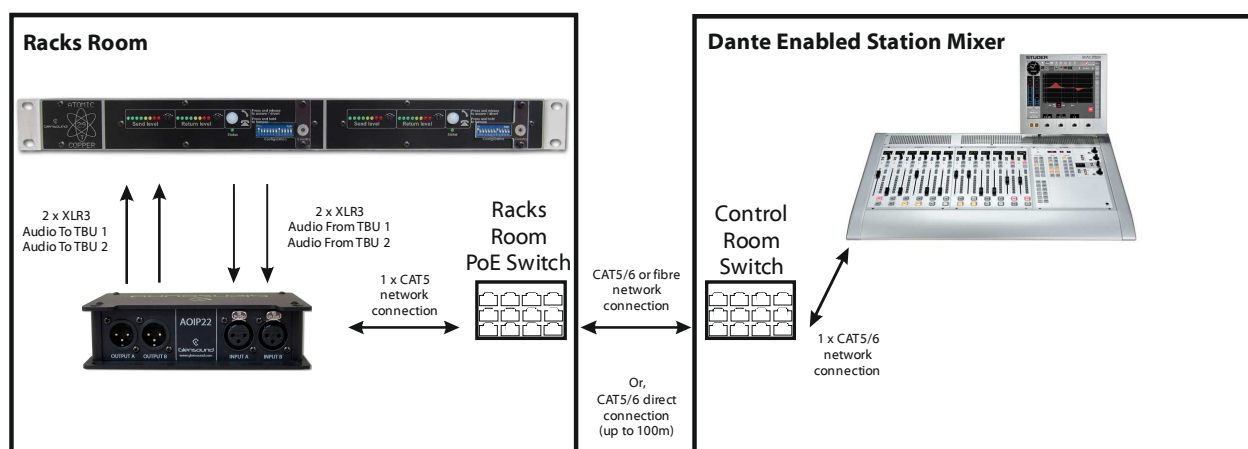

The AoIP22 is the perfect choice for installing in the back of a rack for interfacing legacy analogue audio equipment to your Dante network.

In this example the AoIP22 is used to interface to a two channel Telephone Hybrid but this could also easily be a two channel ISDN or Ip Codec. The AoIP22 is installed in the back of the rack using cable ties through the fastening points.

It is then connected to the network switch in the station's racks room, this switch provides power to the AoIP22 via PoE. If the switch doesn't supply PoE then a mid span PoE injector can be used.

The two audio inputs to the AoIP22 are connected to the two output audio circuits of the telephone hybrid, and they are converted to network audio streams sent across the network to stations desk where they appear as two input channels.

Two return clean feed output circuits are routed across the network from the desk to the AoIP22s outputs. These are then connected on XLR cables to the two audio inputs on the telephone hybrids.

Using the AoIP22 in this way will allow you to continue using your existing analogue based equipment on a modern networked audio infrastructure.

AOIP22 FRONT PANEL LAYOUT



1. Analogue Audio Outputs

The two balanced analogue XLR outputs provide outputs from the Dante® / AES67 network.

They are electronically balanced and set to a line up level whereby full scale (0dBFs) on the digital network equates to an analogue output of +18dBu.

2. Analogue Audio Inputs

The two balanced analogue XLR inputs provide inputs to the Dante® / AES67 network.

They are electronically balanced but can be wired unbalanced.

They are set such that an analogue input of +18dBu equates to full scale (0dBFs) on the digital network.

AOIP22 RIGHT SIDE PANEL LAYOUT

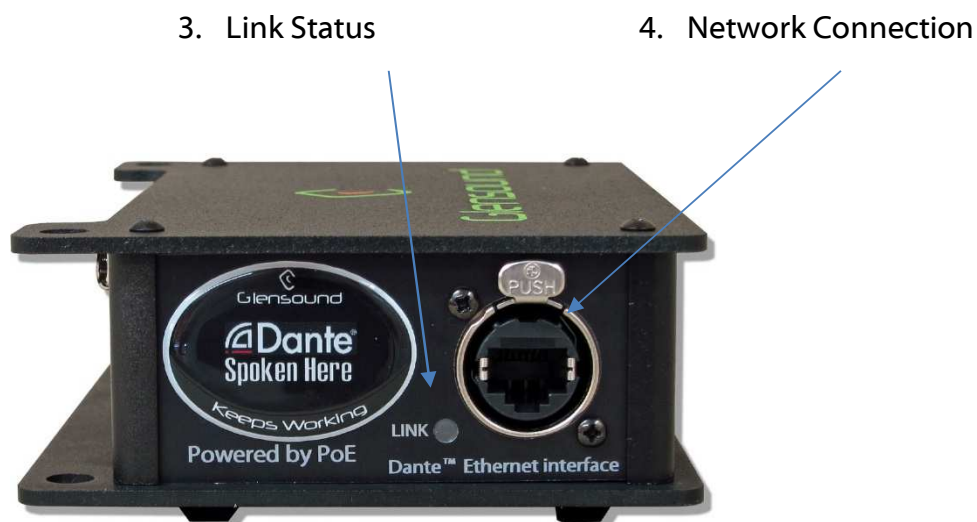

3. Link Status LED

The status LEDs flash to show when data is being correctly communicated with the attached switch.

4. Network Connection

The Ethercon connector can mate with Neutrik XLR based network cables and standard RJ45s.

This should be connected to a PoE enabled switch or to a normal network switch via a Mid Span PoE injector.

It is a 100Mb connection.

AOIP22 LEFT SIDE PANEL LAYOUT

5. Reset Button

6. Micro USB Connector

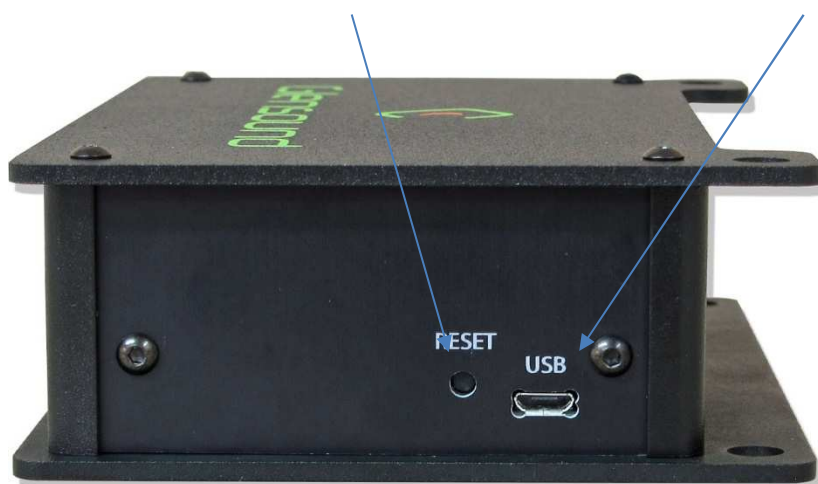

5. Reset Button

The recessed reset button's main function is to allow the firmware within the AoIP22 to be updated.....Please see the 'Updating Firmware' section of this handbook for more information.

6. Micro USB Connector

The Micro-USB connector is used for connecting the AoIP22 to a PC when updating its firmware.... Please see the 'Updating Firmware' section of this handbook for more information.

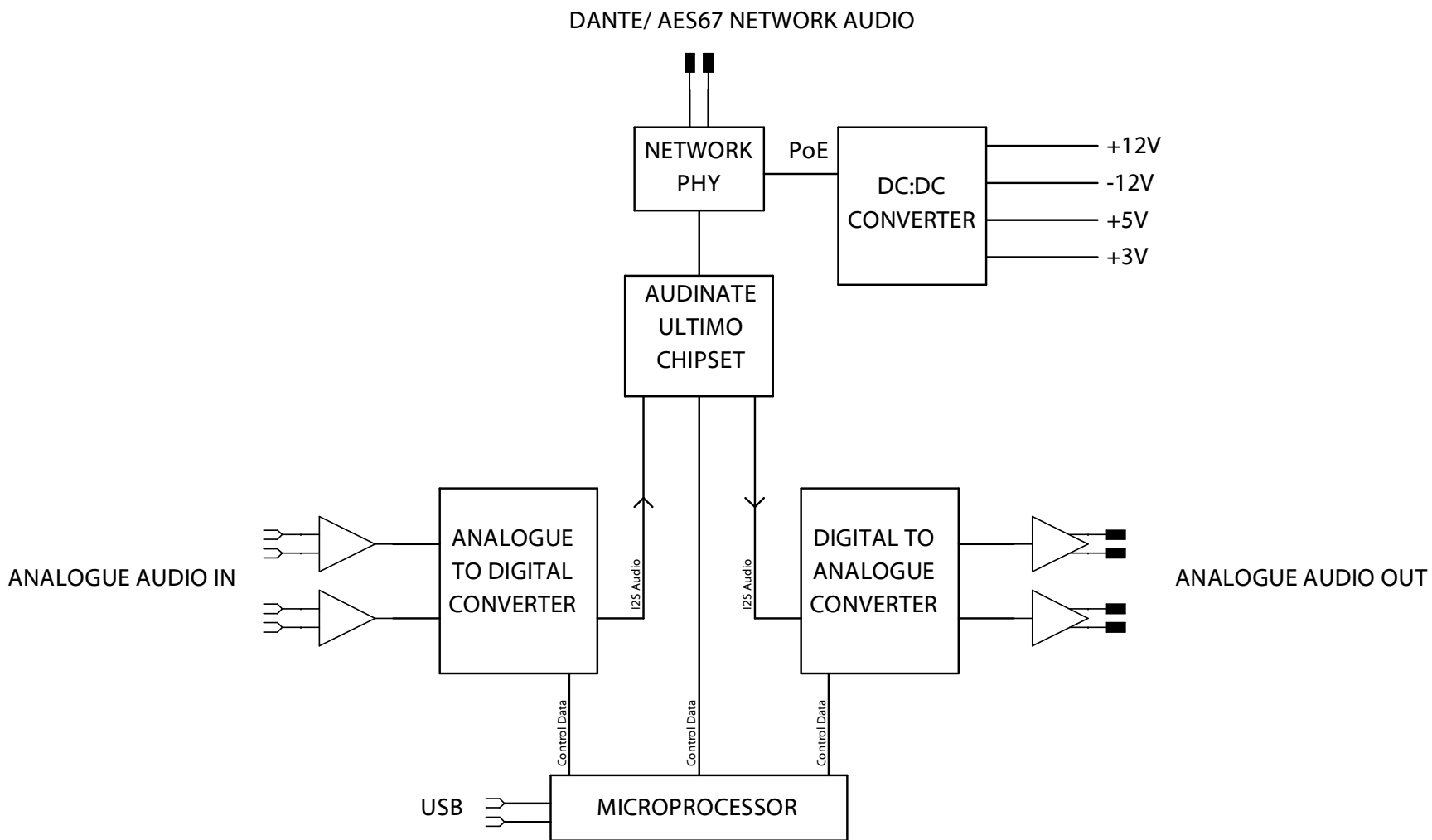

CONNECTING THE AoIP22 TO A DANTE NETWORK

The AoIP22 is a network audio device utilizing the reliable and versatile Dante® audio over IP protocol. Dante® is a widely used proprietary system made by Audinate.

For full details of the power of Dante® network audio and instructions for using it, visit www.audinate.com

Getting Dante Controller

If you are connecting the AoIP22 to a new Dante® network the first thing you will need to do is to get the free Dante® controller software from Audinate.

This can be downloaded by visiting Audinate's web site at www.audinate.com

Connecting AoIP22 To the Network

The AoIP22 can be connected to the network that you are going to use for your audio distribution simply by plugging in the network connection on the front panel. Once connected to the network it will be possible to see the AoIP22 from within the Dante® controller and route its' audio circuits.

Audio Over IP Network

We strongly recommend that you consider your network topology carefully and would not recommend sharing broadcast audio and general data on the same network.

For more details of audio over IP network structure please visit www.audinate.com

Running Dante Controller

At the time of writing this manual the Dante® Controller looks as per the screenshot below:

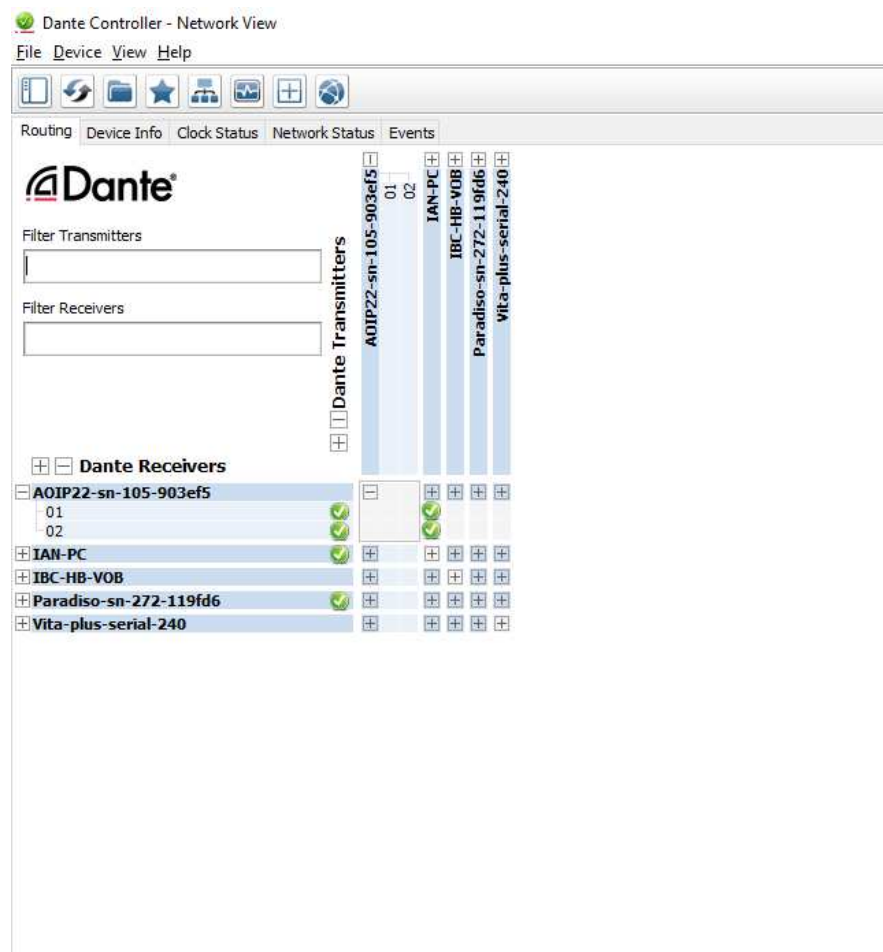

The AOIP22 will have been named at the factory during test to allow them to be identified by the Dante® controller.

The format used for the factory name is:

‘AOIP22-sn-105-903ef5’

Where ‘AOIP22-sn-105’ refers to the Glen sound product and its serial number and ‘903ef5’ refers to its MAC address.

Dante Controller TIP

If you have never run Dante® controller before then make sure that on the bottom left of the Dante controllers’ screen ‘P’ or ‘S’ is next to a green square as this indicates that it is connected to a network. By clicking ‘P’ or ‘S’ a pop up box opens to allow you to set what network interface the controller is using.

AES67 MODE

The AoIP22 uses a chipset from Audinate called Ultimo for its network audio interface. Audinate are the company behind Dante® and as such the chipset's primary network audio protocol is Dante®, however Audinate have enabled their chipset to comply with AES67 and therefore the AoIP22 can be set to AES67 mode for interaction with other AES67 devices.

Please note however that Glensound are relying on Audinate's AES67 interface and are unfortunately not able to provide full AES67 support for the unit. AES67 support should be sought directly from Audinate.

1. Turning On AES67 Mode

If you want to use your AoIP22 on an AES67 network and it has not been set to AES67 mode then this can be set in Dante® controller by double clicking the AoIP22 to open the Device View window where you will find an AES67 tab to enable AES67 support.

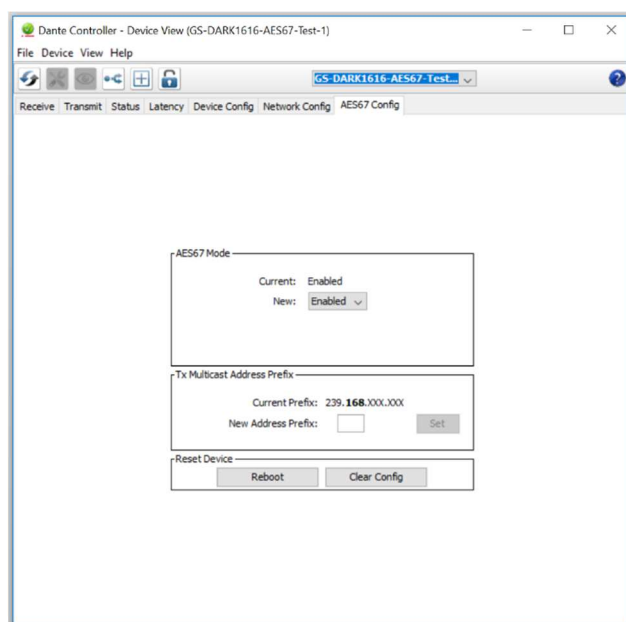

Once the AES67 drop down box has been enabled you'll have to reboot the AoIP22 for the change to take effect. After the reboot go back to the AES67 tab and set the multicast prefix address to one that is suitable for your network.

2. Sending AES67 Audio

To transmit AES67 audio to the network a multicast flow must first be setup.

This is done by selecting the 'Create New Multicast Flow' Icon  in the Device View.

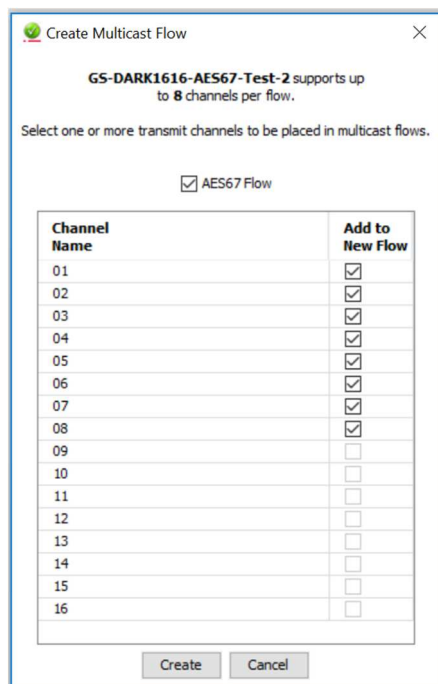

Tick the AES67 Flow check box, then select up to 8 channels to be included in the flow then click 'Create' (The AoIP22 only has 2 channels so no more than that can be created).

Once set the flows can be seen in the transmit tab of the device view.

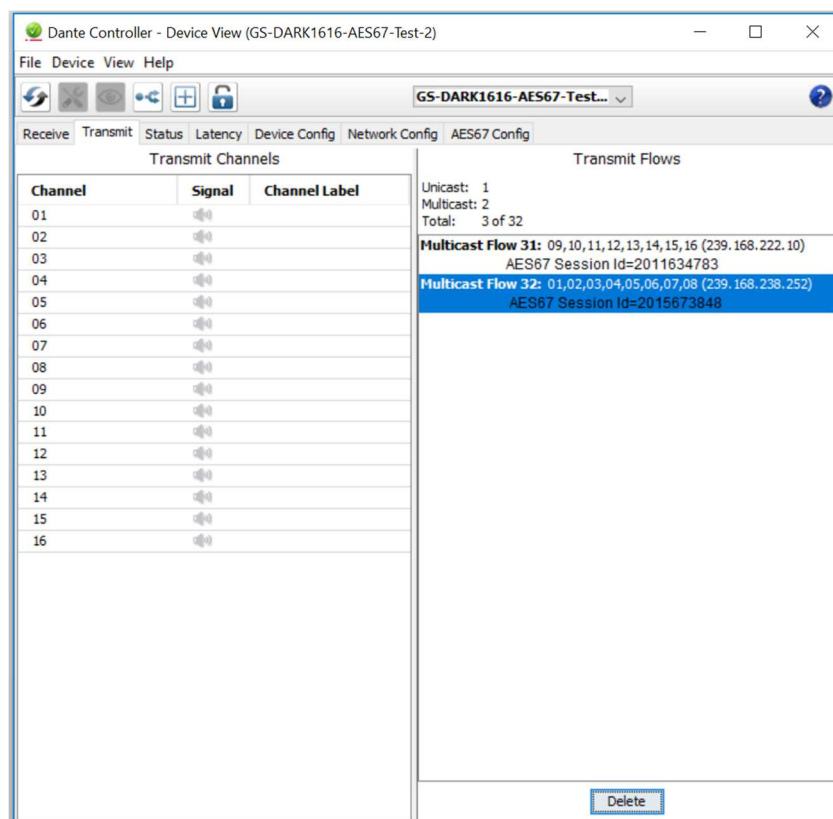

3. Receiving AES67 Audio

Once a compatible AES67 stream is detected on the network by Dante® Controller the AES67 flows will appear in the Dante Transmitters section in the Routing tab.

4. AES67 Restrictions

AES67 flows can only be generated with the following constraints:

- Multicast Only
- Non-redundant
- Destination address in range 239.nnn.0.0 to 239.nnn.255.255 (239.nnn/16), port 5004
- 48kHz sampling rate
- 24 bit linear (L24) encoding
- 1 msec packet time
- Up to 8 channels per stream

Received AES67 flows have the following constraints:

- Multicast Only
- Non-redundant
- Destination address in range 239.nnn.0.0 to 239.nnn.255.255 (239.nnn/16), port 5004. Must match destination address range.
- 48kHz sampling rate
- L16 or L24 encoding
- 125usec, 250usec, 333usec, 1 msec packet time
- Up to 8 channels per stream

UPDATING FIRMWARE

The AoIP22 is a digital audio system comprising of a Micro Controller and ADC and DAC converters. These items run software and may need to be occasionally updated.

Equipment needed

- A windows based PC
- USB Type A to Micro B cable
- A copy of 'DfuSe Demo' software
- The latest firmware from Glensound
- An AoIP22

Instructions

1. Download and install DfuSE Demo

'DfuSE Demo' is a firmware updating tool that is required for loading new firmware on to the AoIP22.

It can be downloaded from the STMicroelectronics website found here: <https://goo.gl/AbzhsA>. It is the file named "STSW-STM32080".

Once you have downloaded this file you will need to extract the .exe "DfuSe_Demo_V3.0.5_Setup.exe", then run and install it.

2. Download firmware

The latest firmware for the AoIP22 can be found on the Glensound website, under the product page for AoIP22. Once you have downloaded the file, place it in a folder or location of your choice.

Name	Date	Type	Size
 Dark1616S1.1.1.dfu	21/03/2018 11:18	DFU File	47 KB

Figure 1 Example filename

3. Connect To A PC

Connect the AoIP22 to the PC via the USB cable. The Micro USB connector is located on the left panel of the AoIP22.

4. Firmware update preparation

To prepare the AoIP22 for a firmware update;



Figure 2 Left panel USB connector

1. Press and hold down the reset button
2. Power on the unit (connect to a PoE switch)
3. Release the reset button

Your PC should make an audible sound when this process is successful as windows is detecting a new USB device.

5. Loading the firmware

Now open DfuSe Demo.

If the AoIP22 successfully entered DFU mode then it will appear as 'STM Device in DFU Mode' under the 'Available DFU Devices tab'.

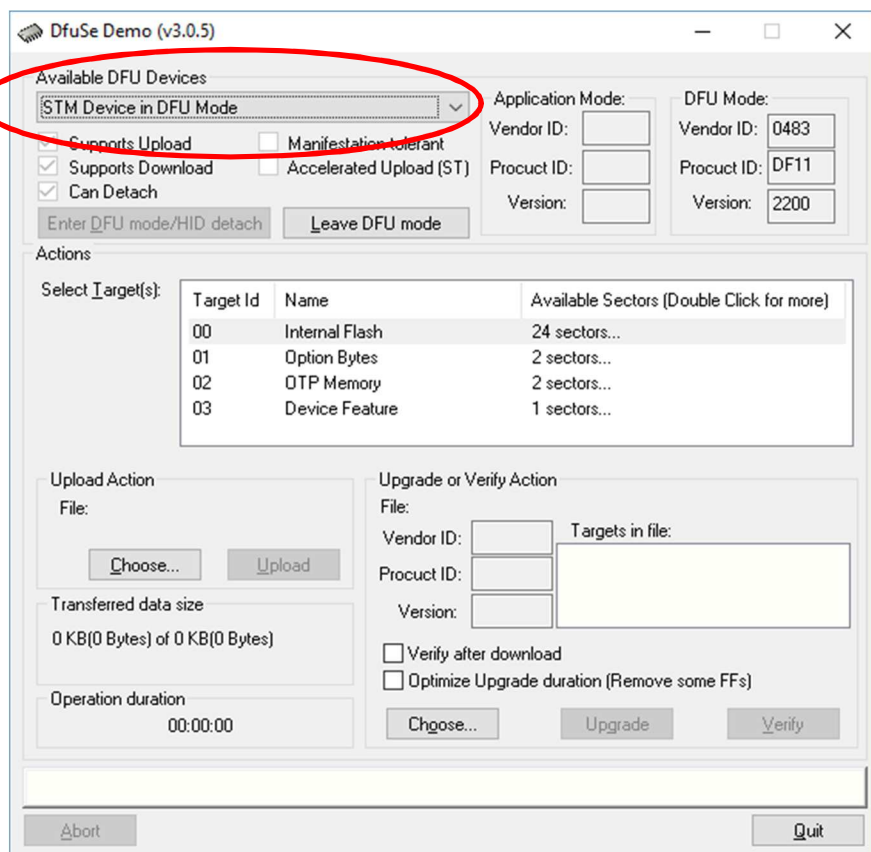

Figure 3 Device successfully recognised

Now the .dfu file needs to be selected so that DfuSe Demo knows the correct firmware to put on to the AoIP22.

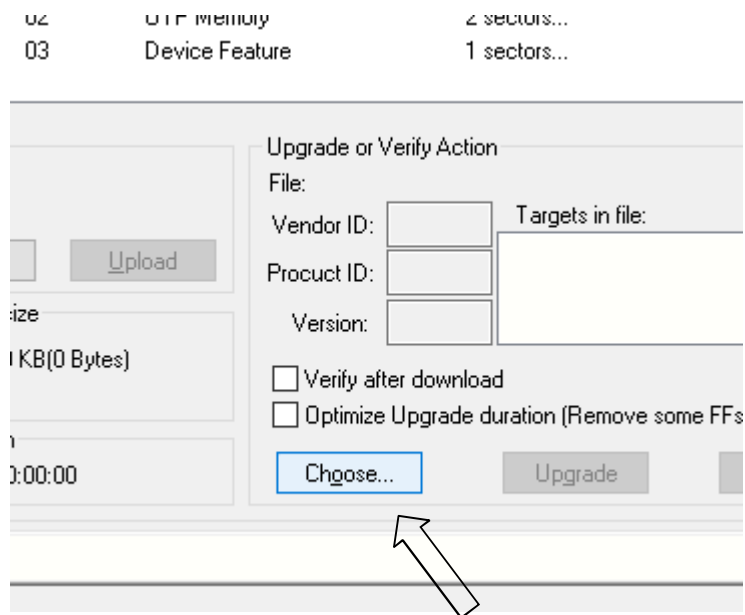

Figure 4 Choose .dfu file

Click choose and then select the .dfu file that you downloaded from the Glensound website. This will be located in your downloads folder by default.

If the file loads successfully then it will read along the bottom 'File correctly loaded'.

6. Upgrading the AoIP22 firmware

The firmware is now ready to be put on to the AoIP22. Tick the 'Verify after download' box first and then click 'Upgrade'.

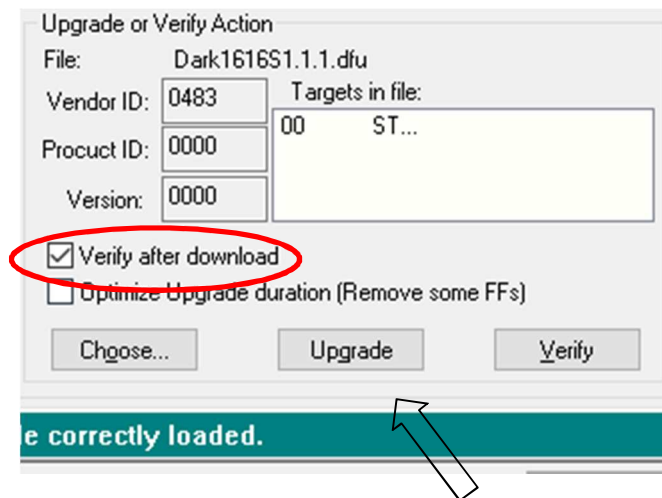

Figure 6 Upgrade

Click yes to proceed.

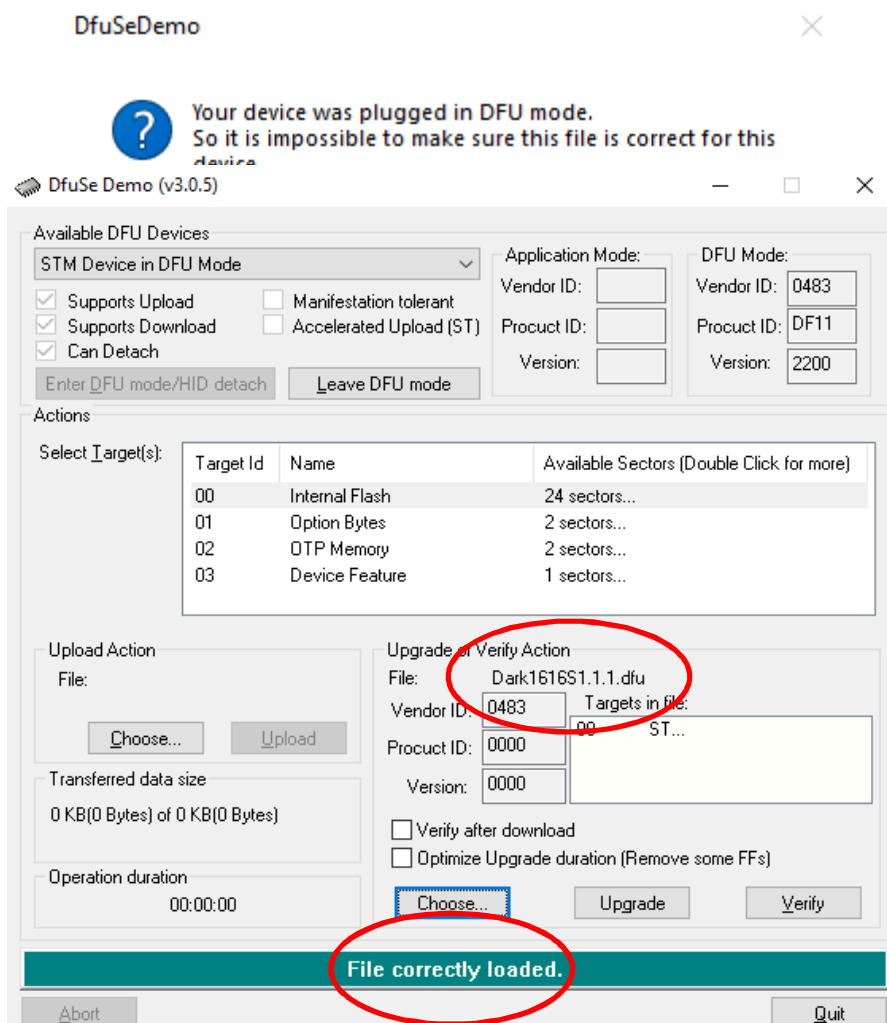

Figure 5 .dfu successfully loaded

The progress bar along the bottom will show the status of the operation. If the operation was successful, DfuSe Demo will report that “Target 00: Verify Successful!”.

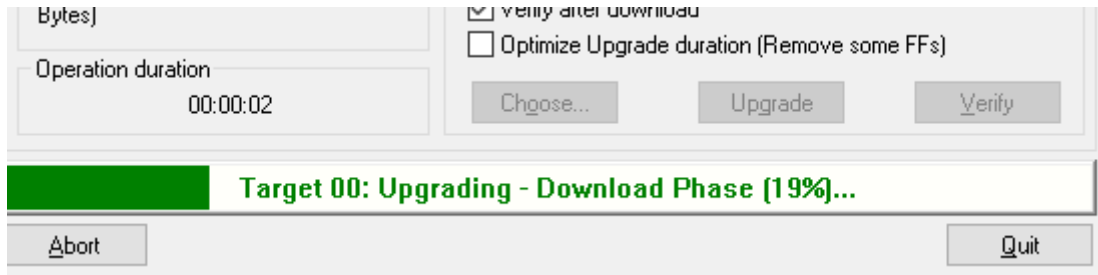

Figure 8 Upgrade status

You may also see that it will report how much data was successfully transferred.

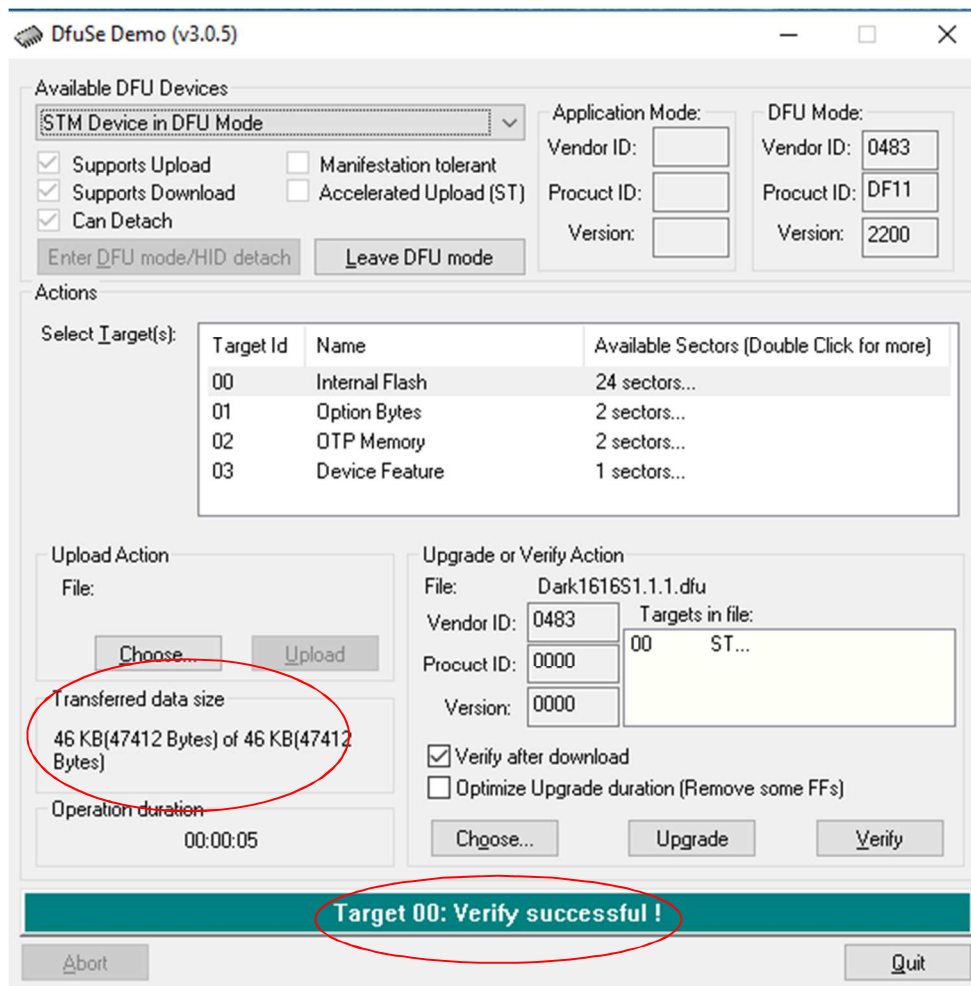

Figure 9 Successful upgrade!

7. Final steps

Now click “Leave DFU mode” to finish the procedure.

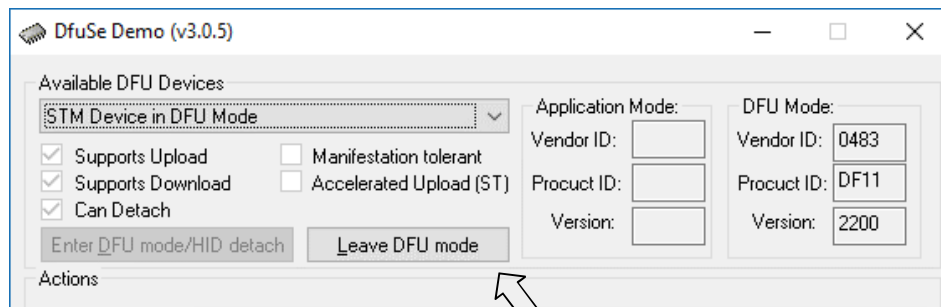

Figure 10 Final step

You may now disconnect the USB cable and continue to use the AoIP22 with the freshly updated firmware!

UPDATING THE ULTIMO CHIPSET

The Ultimo Chipset is a device supplied by Audinate that does most of the processing for the actual Dante/ AES67 network audio streams. There is one Ultimo Chipset in each AoIP22. We supply special code (a .dnt file) that sets up/ initiates the Ultimo Chipset and makes it work in particular way that is compatible to the AoIP22.

1. Finding Out Current Installed Version

Using Dante® controller double click on the AOIP22 device name in the routing tab to open the Device View box.

On the Device View box open the Status Tab.

The 'Product Version:' shows the currently installed version of Ultimo Chipset dnt code.

2. Finding Out What The Latest Available Version Is

Go the AoIP22's web and open the 'Firmware Latest Version' Tab.

This will give both the latest version numbers/ file names and also the location to download the file from.

3. Updating the Brooklyn Module

The firmware that runs in the Ultimo Chipset is updated using Audinate's Firmware updating tool. The updating tool and a user guide can be downloaded from Audinate's website:

<https://www.audinate.com/products/firmware-update-manager>

NOTE:

Please note we strongly advise that when you do the update that only your PC and the Paradiso that you want to update are on the network to save accidentally updating the wrong Dante device.

WIRING INFORMATION

1. Standard Pin Outs

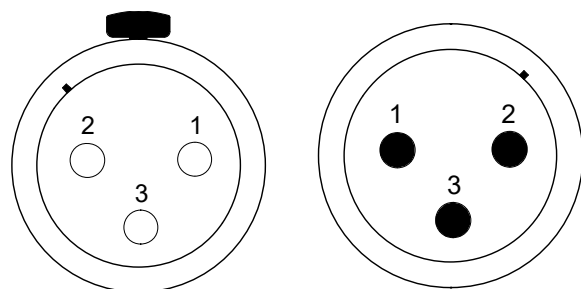

XLR SOCKET (FEMALE)

XLR PLUG (MALE)

STANDARD XLR AUDIO PINOUTS:

1: Ground/ Earth

2: INPHASE/ POSITIVE/ MIC +

3: MATE/ NEGATIVE/ MIC -

2. Wiring to unbalanced devices

The input & output circuits of our equipment can be connected to unbalanced (domestic style) devices. The wiring diagrams below show a mono jack plug as the unbalanced end of the cable but this of course could easily be a different type of connector such as an RCA Phono or 'D' type connector.

BALANCED OUTPUT

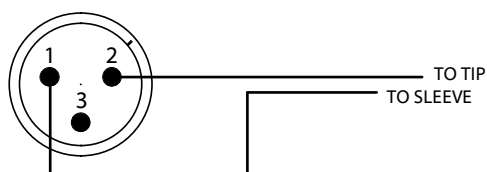

UNBALANCED INPUT



BALANCED INPUT

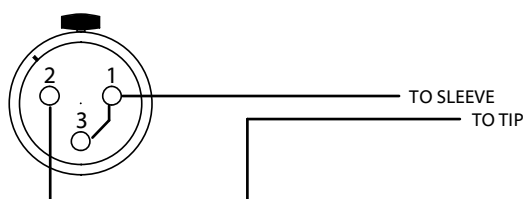

UNBALANCED OUTPUT



Domestic devices generally work on different audio levels than professional devices such as ours. This may mean that the output of the AoIP22 seems a little high and the input seems a little low when the AoIP22 is interfaced to a domestic device.

SPECIFICATION

AUDIO

Frequency Response

20Hz to 22k $\leq \pm 0.25$ dB

Maximum Input Before Clip

+18dBu

Maximum Output Level

+18dBu

Input Impedance

>20 k Ω

Output Impedance

50 Ω

Distortion (Analogue in to Dante Out)

0.0013% THD+N @ 1kHz

Reference to +18dBu output

Distortion (Dante in to Analogue Out)

0.0026% THD+N @ 1kHz

Reference to +18dBu output

Noise (Analogue In & Out @ 0dBu)

-92dBu (Residual)

Dynamic Range

108dBs

Crosstalk (0dBu input to output 1k tone)

-135dBu

Output Type

Electronically balanced (can be wired unbalanced) on Neutrik 3 pin XLR plug

Input Type

Electronically balanced (can be wired Unbalanced) on Neutrik 3 pin XLR socket

Digital Full Scale

+18dBu = 0dBFS

PHYSICAL

Size

153 x 105 x 41mm (WxDxH)

Excluding Beltclip

Weight

420g

Mechanics

All aluminium construction, anodized and laser etched

POWER

PoE

2.6 Watts

Source

PoE Enabled Switch or Mid-Span PoE Injector

NETWORK AUDIO

Compatible Audio Networks

Dante® uncompressed, low latency audio. AES67

Network Connection

Neutrik RJ45 EtherCON

Dante Network Sample Rate

44.1k, 48k, 88.2k, 96k

AES67 Network Sample Rate

48k

INCLUDED ITEMS

Handbook

Paper Copy (Download also available)

Rj45 Network Cable

2 metre Cat5 Rj45 plug/ Rj45 plug cable

Beltclip

Fitted

E & OE